



Gesamtkatalog

Catalogue général



2024/25

Besuchen Sie auch unseren Onlineshop

Visitez notre boutique en ligne

- Über 15'000 Artikel
- Aktionen in der Übersicht
- Filter- und Suchfunktion
- Login mit Bestell-Übersicht
- Offert-Anfrage
- Plus de 15 000 articles
- Offres spéciales dans la vue d'ensemble
- Fonction de filtrage et de recherche
- Login avec vue d'ensemble des commandes
- Demande d'offre



shop.berndorf.ch

Porzellan | Porcelaine

Seite | Page
12-167

Besteck | Couverts

Seite | Page
168-215

Glas | Verrerie

Seite | Page
216-275

Service | Service

Seite | Page
276-471

Küche | Cuisine

Seite | Page
472-565

Apparate | Appareils

Seite | Page
566-627

Transport&Reinigung Transport et nettoyage

Seite | Page
628-704

stichwort- verzeichnis



Verpackungseinheit



Lieferfrist/Wochen



Lagerartikel

a			
Abfalleimer	690-693		
Abrollvorrichtung	507		
Absolut	193		
Absperrpfosten	419		
Accessoires	206-211		
AdHoc	262, 324-335		
Afinox	426-429		
Airpot	299-300		
Alaska	234		
Alpina	175		
Alu Chef	476-478		
America 20's	255		
Anliker	606		
Appetizer	154-161		
Aramis	232		
Arcadie	259		
Arcoroc	271		
Ariane	192		
Astoria	191		
Atelier	200		
Aufschnittmaschine	616-617		
Ausroller	552		
Ausstecher	555-556		
Austerngabel	211		
Austernmesser	516		
Avantgarde	64-65		
b			
Backblech	546-548		
Backform, Porzellan	95		
Backpinsel	553		
Backschaufel	490-491		
Bactainer	696		
Baguette vintage	185		
Bahia	140-141		
Bain marie	584		
Bali	172		
Bambino	212		
Bamix	598-599		
Bankettkartenständer	315		
Barblender	624-625		
Bartender	255		
Bauscher	14-121, 165		
Beard	204-205		
Beistelltisch	411-413, 415		
Belmore	203		
Besteckbehälter	395-398		
Black Hobstar	245		
Black Star	487		
Black Steel	487		
Blackline	437		
Blitzkocher	595		
Blixer	604-605		
Blu'box	650-658		
Blu'therm	658		
Blu'tray	653		
Bonleiste	507		
Bonn/Bistro	72-75		
Bostonshaker	288-289		
Bräter, Gusseisen	474-478		
Bratpfanne	484-487		
Bratwender, Polyamid	493		
Brilliant	295		
Brotkorb	306-307		
Brotmesser	348		
Brotschneidebrett	364		
Brume	138-139		
Budelles	266-267		
Buffetbrett, Holz	362-375		
Buffetkorb	376-381		
Buffetplatte, Melamin	357-361		
Butterkühler	307, 353		
Butterstreicher	210		
C			
Caffeino	259		
Caldissimo	118		
Caldo Casa	647-649		
Caldomat	585		
Caldoset	118		
Calypso	128-129		
Camtray	430-432		
Camtread	437		
Cannes	252		
Capitol	202		
Carat, Isolierkanne	296		
Carat, Porzellan	86-89		
Carats	242		
Carino	212		
Carlton	190		
Cascada	231		
Cateringboxen	678-684		
Cellresist	485		
Cerealenspender	385-386, 388-388		
Chafing Dish	400-407		
Chafing Dish Besteck	341-344		
Champagnerflaschenverschluss	285		
Champagnerkühler	278-283		
Chasseur	475		
Chilewich	442-455		
Chilischneider	325		
Circle	270		
Classic Baguette	184		
Cocktail, Gläser	254-255		
Cocktailmass	288		
Cocktailshaker	288-289		
Coffee to go	100		
Coffeelings	96-99		
Coffeetime	162		
Cognac Gläser	257		
Collection L. couture ivoire	130-131		
Collection L. fragment	132-133		
Colora	166-167		
Cooling Cup	119		
Coolplate	372-375		
Cornflakespender	385-386, 388-389		
Costaverde	142-143		
Country house	42-45		
Coupes	264-265		
Cultus	223		
Cylinder Bud	255		
d			
Darioform	549		
Decanters & Carafes	266-267		
Deckel für Porzellan	116-119		
Degrenne	130-141, 235		
Dekantiertrichter	286		
Denk'art	218-219		
Dessertgläser	265		
Dialog	82-85		
Digestif, Gläser	256-257		
Digestifwagen	409, 413		
Dimension	78-81		
Dosenöffner	506-507		
Dressiersack	551		
Dressinglöffel	347		
Dressingtopf	381		
Drop Stop	285		
e			
Earth Tray Wave	435		
Ecoglide	485		
Eierkocher	583		
Eierkorb	377		
Eierplättli, Porzellan	95		
Eierteiler	506		
Eiseimer	284		
Eisportionierer	555		
Eiswürfelmaschine	623		
Eleganza	295		
Empilable	271		
Endeavor	241		
Endura	230		
Enjoy	60-63		
Entsafter	612-614		
Essig/Öl	322-328		
Essstäbchen	211		
Etolit	689		
Ettikettiergeräte	564-565		
Everest	240		
Exoglass	547		
Exopan	547		
f			
Filet Béard	204		
Filet Classic	183		
Fino	228		
Fischteller	30		
Flambierbrenner	548		
Flambierpfanne	399		
Flambierrechaud	399		

stichwort- verzeichnis

Flambiertrolley	410
Flaschenhalter	285
Flaschenvakuumpumpe	285
Fleischhaken	506
Fleischklopfer	513
Flüssigkreidemarker	313
Folienabreissgerät	507
Frames	372-377
Frischhaltehaube, Kunststoff	362-364
Fritteusen	579-581
Frittieröltester	562
Frittirschaufel	489
Frühstückswagen	662-666
Fusiontec	402, 475

g

Gasbrenner	548
Gastronorm	164
Gebäckzange	344
Geflügelschere	516
Gemüseschneidemaschine	606-607
Gemüeschüssel, Inox	356
Gemüsesieb	499
Gemüsezentrifuge	612-614
Geschirrwagen	633
Getränkekühler	278-283
Getränkespender	387-394
Getränkestation	417-418
Gibraltar	236-237
Gin Tonic	255
Glacegläser	265
Gläserwagen	633
Glasmanager	681-682
Glencairn	257
Globe	403-404
Glühweinapparat	592-593
GN-Behälter, Inox	527-538
GN-Behälter, Polycarbonat	538, 540-541, 544
GN-Rost	550
GN-Schale, Melamin	359
GN-Schale, Porzellan	164-165
GN-Schalen, Melamin	539
GN-Schalen, Polypropylene	542-543
GN, Function	165
Göffel	207
Gourmet	134-137
Grand Cru	224
Grappa Gläser	257
Gratinform, Porzellan	95
Guerdon	411-413
Gummispachtel	496

h

H-Pan	544
Hackblock	513
Hamburgerpresse	506
Handtuchspender	701
Handwaschbecken	700

Heart & Soul	122-127
Heissgetränkeapparat	592-593
Hering Berlin	144-153
Hermitage	195
Hobstar	243
Hobstar Black	245
Hobstar Colored	244
Hold-o-mat	584
Holzbrett	362-375
Holzöffel	492
Hot&Fresh	400
Hotello	295
Hummerbesteck	211
Hurricane	255
Hygienebrett	511-512

i

Impression	174
Induktionskochplatte	568-570
Induktionsporzellan	114
Industar	485
Invita	112-113
Ironstar	487
Isobox	659-661
Isole	248
Isolierkanne	294-300

j

Jigger	288
Joker	196
Jolie Table	128-129, 201-203

k

Kaffeegläser	259
Kaffeekanne, Inox	290-296
Kaffeemaschine	594
Kaffeestation	417-418
Kai	524-526
Kapselschneider	287
Karaffen	266-267
Karamelisierer	548
Kartoffelpresse	505
Käsedose	321
Käsehobel	349, 504
Käsemesser	210
Käsereibe	349
Kasserolle, Porzellan	95
Kaviarkühler	353
Kaviaröffel, Perlmutter	211
Kehrschaufelset	685
Kellermesser	286
Kenia	259
Kesselbesen	494
Kinderbesteck	212-214
Kindergeschirr	101
Kisag Whipper	508-509
Knoblauchpresse	505
Knöpflblech	505

Kochplatten	568-572
Kochtopf	479-481
Kofferrwagen	699
Kontaktgrill	572
Korbroller	642
Korkenzieher	286
Krankenhausporzellan	102-119
Kreidemarker	313
Kreidetafel	313
Kuchengitter	550
Küchenleiste	507
Küchenmaschine	608-611
Küchenmesser	514-526
Kuchenplatte, Inox	356
Küchenschere	516
Küchenschüssel	498-499
Küchensieb	497-498
Küchenwaage	617-619
Kühlakku	374
Kühlschrankthermometer	562
Kühlvitrine	621-622
Kunststoffgläser	272-275
Kutter	603-604

l

Langustenbesteck	211
Lareyna	177
Latte Macchiato	259
Le Creuset	474
LED Tischleuchte	464-471
Legumier, Inox	356
Leuchter	318-319
Lexington	239
Little Sweeties	214
Little World	101, 215
Livecookintable	420-425
Löwenkopfterrine	95
Luigi Bormioli	260-261
Luzifer	94-95

m

Magic Saver	642
Maitre	68-71
Mandoline	504
Marie Christine	76-77
Marquis	231
Mateo	187
Mehlschaufel	501
Mehlsieb	550
Menagen	321-328
Messbecher	500-501
Messer	514-526
Microban	433
Microplane	502-503
Mikrowellengerät	583
Milchdispenser	393-394
Milchkanne, Inox	290-296
Mini Patisserie	263

stichwort- verzeichnis

Mixer	596-599, 602
Mixology	255
Modern Rustic	50-53
Moscow Mule & Julep Mug	253

n

Nachtmann	231-232
Napoli Grande	255
Nestbacklöffel	490
New Galaxy	268
Newport Twist	235
Newport, Tablett	440
Nick&Nora	255
Niedertemperaturgerät	584-585
Noser	479-481, 483-484

o

Obstzentrifuge	612-614
Offenausschank	266-267
Öl/Essig	322-328
Olivenholz	369
Onis	230, 236-245
Options	54-59
Orfilia	269
Ovation	197

p

Palazzo	194
Palmilla	188
Paneled Tumblers	238
Parmesandose	321
Passe-Vite	505
Passiergerät	505
Passiersieb	497-498
Pastamaschine	615
Pastazange	343
Pastetenform	510
Patientengeschirr	102-119
Patisseriesieb	550
Patisseriezange	344
PBT, Kunststoff	166-167
Pearl	178
Pepe	325
Perfect Match	122-127
Perle	247
Pescado & Laguna	30
Peugeot	336-338
Pfeffermühle	324-338
Pinsel	553
Pinzette	492
Pizza	163
Pizzateller	163
Pizzautensilien	558-560
Plastikgläser	272-275
Plate Mate	643-644
Plateau, Inox	354-356
Poldina	464-471
Pommes Frites Schneider	505

Portionenschöpfer	347
Porzellanlöffel	59
Porzellanreiniger	689
Poubelle de Table	315
Power	227
Prestige	232
Primera	180
Profboard	511
Pulltex	286
Pumpenkrug	299-300
Purity	18-31
Purity Reflections	16-17

r

Radiant	242
Raffel	504
Raffinesse	32-35
Rechnungshalter	311, 314
Referenzöl	562
Regalwagen	640-641
Reibe	504
Reinigungsmaterial	685-699
Reiskocher	582
Relation Today	66-67
Revolution	226
Robot Coupe	603-605
Rohkostreibe	504
Royal Baguette	186
Royal Chippendale	182
Royal Solitude	181
Rührbesen	494
Rum Gläser	257

s

Sahara	205
Salamander	573
Salatbuffet	426-429
Salatschleuder	500
Salatzange	343
Salz und Pfeffer	321-339
Salzmühle	324-338
Samoa, Besteck	198
Samoa, Glas	250-251
Samoa vintage, Besteck	199
Samovar	393
Sanamat	612
Sandstone	46-49
Saucentopf	381
Sauteuse	483-484
Savoy	179
Scandinavia	176
Schaber	552-553
Schaltuhr	563
Schaumlöffel	489
Schneckenabel	211
Schneckenplatte, Inox	356
Schneebesen	494
Schneidebrett	511-512

Schneidemaschine	616-617
Schneidegeräte	514-526
Schockfroster	623
Schöpfkellen	488
Schürzen, Leder vegan	462-463
Schüssel	498-499
Scope	36-41
Screwpull	286
Seifenspender	701-703
Sektflaschenverschluss	285
Sektkühler	278-283
Selbstbedienungstabletts	431-441
Selena	213
Sensus	222
Servicestation, wetterfest	417-418
Servierbesteck	341-344
Servierbrett, Holz	362-375
Serviertabletts	431-441
Serviertrolley	409-414
Servierwagen	630-636
Serviettenhalter	379
Shaker	288-289
Silberreinigungsmaterial	688
Silikonbackformen	557
Sincerus	233
Smart Dekor	92-93
Smart White	90-91
Smartie	213
Soho	245
Soufflé	95
Sous Vide Garer	574-578
Spachtel	552-553
Sparschäler	515
Spätzliblech	505
Special Design	120-121
Speisentransport	650-666
Spitzsieb	497-498
Spülkörbe	667-677
Stäbchen	211
Stabmixer	596-599
Standrührgerät	608-611
Stapelgeräte	645-646
Steakmesser	208-209
Stölzle	225-229, 245-246
Streudose	350
Suppenschöpfer	347
Suppenschüssel, Inox	356
Suppentopf	591
Sushibrett	370
Symphony	229
Systemporzellan	102-119

t

Tablemats	442-455, 458-461
Tablett, Inox	354-356
Tablett, Leder	310-312
Tablettabräumwagen	637-639
Tabletts	431-441

stichwort- verzeichnis

Tassenwärmer	588
Teatime	262
Teebox	350
Teegläser	259
Teekanne, Glas	262
Teekanne, Gusseisen	301-303
Teekanne, Inox	290-296
Teesieb	351
Teigroller	552
Tellerstapler	642-644
Tellerwärmer	589-590
Testo	561-562
The Summit	142-143
Thermic	260-261
Thermoboy	298
Thermometer	561-563
Thermoskanne	294-300
Timeless	201
Timer	563
Tischabfalleimer	315
Tischleuchte	464-471
Tischnummernschild	316
Tischset	442-455, 458-461
Toaster	582
Toccata	189
Tortenheber	347
Tortenplatte, Inox	356
Tourbillon	173
Tranchierbrett	511-512
Transportbehälter	545
Transportboxen	678-684
Transportwagen	630-636
Treteimer	690
Triangle	492
Trichter	501-502
Trolley	409-414
Trüffelhobel	350, 516
Tülle	551-552
Twister	246

U

Unbreakable	272-275
Universalraffel	504
Universalzange	343
Unratzange	685

V

Vakuuiermaschine	619-620
Variomet	118
Vesco	690
Vinoble	220-221
Vitamat	612

W

Waage	617-619
Warm Beverage	258-259
Warmbuffet	426-429
Wärmelampen	586-588

Wärmeteller	118
Warmhaltegerät	584-585
Wäschesammler	694-696
Wash	298
Wasserkocher	595
Wasserspender	387-394
Wave	296-297
Weck	158-161
Weinausgiesser	285
Weingestell	285
Weinkaraffen	266-267
Weinkühler	278-283
Weinland	225
Weinvakuumpumpe	285
Whipper	508-509
Whisky Gläser	257
Windlicht	318-319
Wok	485
Worktop	454-455

Z

Zafferano, Glas	247
Zafferano, Tischlampen	464-471
Zahnstocherhalter	323
Zakouski Löffel	210
Zalto	218-219
Zante	249
Zapfenzieher	286
Zestenreibe	349
Zic Zac	456-463
Zimmerservicewagen	415-416
Zinc	259
Zitronenschnittpresse	350
Zutatenbehälter	545

catégories alphabétiques



Unité d'emballage



Délai de livraison
en semaines



Article en stock

a

Absolut	193
Accessoires	206-211
Accus de refroidissement	374
AdHoc	262, 324-335
Afinox	426-429
Alaska	234
Alpina	175
AluChef	476-478
America 20's	255
Anliker	606
Apareil à emballer sous vide	619-620
Apareils à glaçons	623
Appareil de maintien au chaud	584
Appetizer	154-161
Aramis	232
Arcadie	259
Arcoroc	271
Ariane	192
Armoire chauffante	589-590
Assiette à pizza	163
Assiette à poisson	30
Assiette calorifuge, inox	118
Astoria	191
Atelier	200
Avantgarde	64-65

b

Bac à couverts	395-398
Bac GN, inox	527-538
Bac GN, mélamine	359, 539
Bac GN, polycarbonate	538, 540-541, 544
Bac GN, polypropylène	542-543
Bac GN, porcelaine	164-165
Bactainer	696
Baguette vintage	185
Baguettes	211
Bahia	140-141
Bain Marie	584
Balance	617-619
Bali	172
Bambino	212
Bamix	598-599
Bar Blender	624-625
Bartender	255
Bassine	498-499
Battoir à viande	513
Bauscher	14-121, 165
Béard	204-205
Belmore	203
Black hobstar	245
Black Line	437
Black Star	487
Black Steel	487
Blixer	604-605
Bloc de boucher	513
Blu'Box	650-658

Blu'Therm	658
Blu'Tray	653
Bois d'olive	369
Boissons chaudes	592-593
Boîte à thé	350
Bonn/bistro	72-75
Boston Shaker	288-289
Bougoir	318-319
Bouilloire	595
Box de Transport pour catering	678-684
Brilliant	295
Brûleur	548
Brume	138-139
Budelle	266-267
Buffet à salade	426-429
Buffet chaude	426-429

C

Cafetière, inox	290-296
Caffeino	259
Caldissimo	118
Caldo casa	647-649
Caldomat	585
Caldoset	118
Calypso	128-129
Camtray	430-432
Camtread	437
Cannes	252
Capitol	202
Carafe	266-267
Carat	86-89
Carat, pot isolante	296
Carats	242
Carino	212
Carlton	190
Cascada	231
Casserole	479-481
Casserole, porcelaine	95
Cellresist	485
Centrifugeuse	612-614
Chafing dish	400-407
Chalumeau	548
Chandelier	318-319
Chariot à bagages	699
Chariot à débarasser	637-639
Chariot à glissier	640-641
Chariot à liqueurs	409,413
Chariot à servir	409-414
Chariot à vaisselle et verres	633
Chariot de petit-déjeuner	662-666
Chariot de service	630-636, 696, 698
Chariot socle rouleur	642
Chariot, résistant aux intempéries	417-418
Chasseur	475
Chaudron	591
Chauffe-assiettes	589-590
Chauffe-tasses	588
Chevallet	316

Chilewich	442-455
Chinois	498
Circle	270
Ciseaux à volailles	516
Ciseaux de cuisine	516
Classic baguette	184
Cloche, matière synthétique	362-364
Cocktail, verrerie	254-255
Cocktailshaker	288-289
Coffee to go	100
Coffeelings	96-99
Coffeetime	162
Collecteur de linge	694-696
Collection L couture ivoire	130-131
Collection L fragment	132-133
Colora	166-167
Conteneur	690-693
Conteneur de transport	545
CoolingCUP	119
Coolplate	372-375
Corbeille à oeufs	377
Corbeille à pain	306-307
Corbeilles de lavage	667-677
Corbeilles pour buffet	376-381
Costaverde	142-143
Country house	42-45
Coupe légumes	606-607
Coupe oeufs	506
Coupe-capsule	287
Coupe-frite	505
Coupes	264-265
Couteau à beurre	210
Couteau à fromage	210
Couteau à huitres	516
Couteau à pain	348
Couteaux à steak	208-209
Coutellerie	514-526
Couvercles pour porcelaine	116-119
Couverts à homnard	211
Couverts à servir	341-344
Couverts pour enfants	212-214
Crochet à viande	506
Cruche isolante	294-300
Cruche pompe	299-300
Cuillère à caviar, nacre	211
Cuillère à vinaigrette	347
Cuillère à zakouskis	210
Cuillère en porcelaine	59
Cuiseur à oeufs	583
Cuiseur à riz	582
Cuisson-sous-vide	574-578
Cultus	223
Cutter de table	603-604
Cylinder Bud	255

d

Decanters & carafes	266-267
Décanteur	266-267

catégories alphabétiques

Découpoirs	555-556
Degrenne	130-141, 235
Denk'art	218-219
Dérouleur de film	507
Dialog	82-85
Digestif, verrerie	256-257
Dimension	78-81
Distributeur à lait	393-394
Distributeur céréales	385-386, 388-389
Distributeur de boissons	387-394
Distributeur d'essui-mains	701
Distributeur de gants	703
Distributeur de savons	701-703
Douille	551-552
Drop-Stop	285

e

Earth Tray Wave	435
Ecoglide	485
Ecumoire	489-490
Eleganza	295
Empilable	271
Emulsionneur	508-509
Endeavor	241
Endura	230
Enjoy	60-63
Entonnoir décanteur	286
Entonnoir	498, 501-502
Eplucheur	515
Essoreuse	500
Etiqueteuses	564-565
Etolit	689
Everest	240
Exoglass	547
Exopan	547

f

Fermeture champagne	285
Filet béard	204
Filet classic	183
Fino	228
Forme de friand	510
Fouet	494
Fouillère	207
Four micro-ondes	583
Fourchette à escargots	211
Fourchette à huîtres	211
Frames	372-377
Friteuses	579-581
Fusiontec	402, 475

g

Gastronorm	164
Gibraltar	236-237
Glas Manager	681-682
Glencairn	257
Globe	403-404
GN, Function	165

Gourmet	134-137
Grand cru	224
Grille à gâteau	550
Grille à Spätzli	505
Grille contact	572
Guéridon	411-413

h

H-Pan	544
Heart & Soul	122-127
Hering Berlin	144-153
Hermitage	195
Hobstar	243
Hobstar colored	244
Hold-o-mat	584
Hot & Fresh	400
Hotello	295
Huile de référence	562
Hurricane	255

i

Impression	174
Industar	485
Invita	112-113
Isobox	659-661
Isole	248
Itonstar	487

j

Jigger	288
Joker	196
Jolie Table	128-129, 201-203

k

Kai	524-526
Kenia	259
Kisag Whipper	508-509

l

Lampe chauffante	586
Lampe de table à LED	464-471
Lareyna	177
Latte Macchiato	259
Lave-mains mobile	700
Le Creuset	474
Légumier, inox	356
Lexington	239
Little Sweeties	214
Little world	101, 215
Livecookintable	420-425
Louche	347, 488
Luiqi Bormioli	260-261
Luzifer	94-95

m

Machine à café	594
Machine à pâtes	615
Machines de cuisine	608-611

Magic-Saver	642
Maître	68-71
Mandoline	504
Marie christine	76-77
Marmite	479-481
Marqueur à craie	313
Marquis	231
Mateo	187
Matériel roulant	645-646
Ménage huile et vinaigre	322-328
Ménage sal et poivre	321-328
Mesure	500
Mesure à cocktail	288
Microban	433
Microplane	502-503
Mini pâtisserie	263
Minuteur	563
Mixeur plongeur	596-599, 602
Mixology Gin Tonic	255
Modern rustic	50-53
Moscow mule & Julep mug	253
Moule à soufflé	95
Moule Dariole	549
Moules à pâtisserie	557
Moulin à fromage	349
Moulin à poivre	324-338
Moulin à sel	324-338
Moulin passe-légumes	505
Mouvette bois	492

n

Nachtmann	231-232
Napoli grande	255
Nettoyage	685-699
Nettoyage d'argent	688
Nettoyage pour porcelaine	689
New Galaxy	268
Newport plateau	440
Newport twist	235
Nick & Nora	255
Nid à friture	490
Noser	479-481, 483-484
Numéro de table	316

o

Onis	230, 236-245
Options	54-59
Orfila	269
Ouvre-boîtes	506-507
Ovation	197

p

Palazzo	194
Palmilla	188
Paneled tumblers	238
Passoir	497-498
Passoire à thé	351
PBT, plastique	166-167

catégories alphabétiques

Pearl	178	Presse pomme de terres	505	Smartie	213
Pelle à retourner	490-491	Prestige	232	Soho	245
Pelle à tarte	347	Primera	180	Soupière, inox	356
Pelle é farine	501	Profboard	511	Spatule	490-491
Perfect match	122-127	Pulltex	286	Spatule à caviar, nacre	211
Perle	247	Purity	18-31	Spatule polyamide	493
Pescado & laguna	30	Purity reflections	16-17	Special design	120-121
Peugeot	336-338	r		Station pour le service et café	417-418
Photophore	318-319	Rabot à fromage	349, 504	Stölzle	225-229, 245-246
Pichet gradué	500	Racloir	552-553	Support pour carte de banquet	315
Pince à pâtes	341	Radiant	242	Sushi, planche	370
Pince à pâtisserie	344	Raffinesse	32-35	Symphony	229
Pince à salade	343	Rafrichisseur	278-283	t	
Pince gourmet	492	Ramequin	95	Table de service en chambre	415-416
Pince universelle	341	Râpe	504	Table gigogne	415
Pinceau	553	Râpe à truffe	350, 516	Table guéridon	411-413
Pine refusant	685	Ravier à parmesan	321	Tableau a craie	313
Pizza	163	Réchaud à flamber	399	Tablier, cuir vegan	462-463
Pizza ustensiles	558-560	Réchaud à induction	568-570	Tamis à Spätzli	505
Planche à bois	362-375	Récipient pour sauce	381	Tamis à farine	550
Planche hygienique	511-512	Refrichisseur à beurre	307	Teatime	262
Planche tranch-pain	361	Refrichisseur à beurre, inox	353	Terrine tête de lion	95
Plaque à pâtisserie	546-548	Refrichisseur à caviar	353	Testeur d'huile	562
Plaque de cuisson	568-571	Refridisseur rapide	623	Testo	561-562
Plat à gratin, porcelaine	95	Relation today	66-67	The summit	142-143
Plat à oeufs, porcelaine	95	Revolution	226	Théière en fonte	301-303
Plat à tarte, inox	356	Robot Coupe	603-605	Théière en verre	262
Plat aux excargots, inox	356	Rouleau	552	Théière, inox	290-296
Plate à buffet, mélamine	357-361	Royal baguette	186	Thermic	260-261
Plate Mate	643-644	Royal chippendale	182	Thermoboy	298
Plateau	431-441	Royal solitude	181	Thermomètre	561-563
Plateau de service, inox	354-356	s		Thermomètre frigo	562
Plateau, cuir	310-312	Sahara	205	Timeless	201
Poche à dresser	551	Salamandre	573	Tire-bouchon	286
Poêle à flamber	399	Samoa, couverts	198	Toaster	582
Poêle a frire	484-487	Samoa, verre	250-251	Toccata	189
Poldina	464-471	Samoa vintage, couverts	199	Tourbillon	173
Pompe à vin sous vide	285	Samovar	393	Trancheur de piments rouges	325
Pont à chauffage	586	Sanamat	612	Trancheuse	616-617
Porcelaine à induction	114	Sandstone	46-49	Transport d'aliments	650-666
Porcelaine system	102-119	Saupoudreuse	350	Triangle	492
Port-facture	311	Sauteuse	483-484	Twister	246
Porte-assiettes	642-644	Savoy	179	u	
Porte-baquettes	211	Scandinavia	176	Unbreakable	272-275
Porte-bons	507	Scope	36-41	v	
Porte-bouteille	285	Screwpull	286	Vaisselle pour enfants	101
Porte-cure-dents	323	Seau à boisson	278-283	Variomet	118
Porte-serviettes	379	Seau à glace	284	Verre à café	259
Portionneur à glace	555	Selena	213	Verre à cognac	257
Porcelaine de system	102-119	Sensus	222	Verre à dessert	265
Pot à lait, inox	290-296	Set de pelle	685	Verre à glace	265
Pot isolante	294-300	Set de table	442-455, 458-461	Verre à grappa	257
Poteau pour zone interdite	419	Shaker	288-289	Verre à plastique	272-275
Poubelle à pédale	690	Sincerus	233	Verre à rhum	257
Poubelle de table	315	Smart dekor	92-93	Verre à thé	259
Power	227	Smart white	90-91		
Press citron	350				
Presse d'ail	505				

catégories alphabétiques

Verre à whisky	257
Verseur à vin	285
Vinoble	220-221
Vitamat	612
Vitrine réfrigéré	621-622

W

Warm beverage	258-259
Wash	298
Wave	296-297
Weck	158-161
Weinland	225
Wesco	690
Whipper	508-509
Wok	485
Worktop	454-455

Z

Zafferano, lampes à porter	464-471
Zafferano, verrerie	247
Zalto	218-219
Zante	249
Zesteur	349
ZicZac	456-463
Zinc	259





Porzellan | Porcelaine



 **BAUSCHER**
GERMANY

collection bauscher



purity reflections

Seite/Page 16-17



purity

Seite/Page 18-31



raffinesse

Seite/Page 32-35

scope

Seite/Page 36-41



country house

Seite/Page 42-45

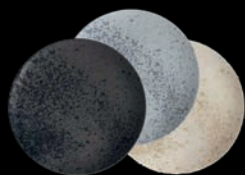

sandstone

Seite/Page 46-49



modern rustic

Seite/Page 50-53



options

Seite/Page 54-59



enjoy

Seite/Page 60-63



avantgarde

Seite/Page 64-65



relation today

Seite/Page 66-67



maître

Seite/Page 68-71

bonn/bistro

Seite/Page 72-75

marie christine

Seite/Page 76-77



dimension

Seite/Page 78-81



dialog

Seite/Page 82-85



carat

Seite/Page 86-89



smart white

Seite/Page 90-91



smart dekor

Seite/Page 92-93



luzifer

Seite/Page 94-95



coffeelings

Seite/Page 96-99



coffee to go

Seite/Page 100



little world

Seite/Page 101



system

Seite/Page 102-119



special design

Seite/Page 120-121



 **BAUSCHER**
GERMANY

purity reflections

Ein spannendes Licht- und Schattenspiel: das Relief reflektiert bei jedem Drehen das Licht anders. Dabei funkelt das Relief wie ein Diamant.

Il en résulte un jeu d'ombre et de lumière captivant: le relief reflète la lumière différemment à chaque fois qu'on le tourne et brille comme un diamant.



Espresso-Untertasse
Soutasse à espresso

20146959051 Ø 14 cm   7.15



Kombi-Untertasse
Soutasse multiple

20146969051 Ø 16 cm   8.65















Untertasse mit 2 Spiegel
Soutasse avec 2 marlis

20147185051 Ø 16,5 cm   8.65



Teller flach rund Fahne
Assiette plate rond bord

20140067051	Ø 17 cm			9.85
20140072051	Ø 22 cm			13.30
20140074051	Ø 24 cm			17.30
20140076051	Ø 26 cm			22.60
20140079051	Ø 29 cm			29.30
20140082051	Ø 32 cm			34.90











Teller tief rund Fahne
Assiette creuse rond bord

20140170051	Ø 20 cm			13.30
20140174051	Ø 24 cm			21.70
20140179051	Ø 29 cm			28.75



Platte oval rund Fahne
Plat oval rond bord

20142068051	18 x 13 cm			20.35
20142074051	24 x 18 cm			29.30
20142083051	33 x 24 cm			46.60
20142086051	38 x 28 cm			58.60

Ergänzen lässt sich das trendige Relief-Porzellan mit den Artikeln von PURITY.

La porcelaine tendance avec relief peut être complétée par les articles de PURITY.





Noble China

 **BAUSCHER**
GERMANY

purity

Purity steht für eine neue Porzellan Klasse von ungewöhnlicher Zartheit und Ausdauer. Denn sie verbindet ästhetischen Purismus mit langlebiger Strapazierfähigkeit.

Purity constitue une nouvelle collection de porcelaine d'une douceur et d'une résistance exceptionnelles. Elle allie une esthétique épurée et une résistance incomparable.



Kaffeekanne komplett Cafetière complète

20144130051	30 cl		38.60
20144131051	30 cl		32.75
20144132051	30 cl		9.85



Teekanne komplett Théière complète

20144340051	40 cl		49.95
20144341051	40 cl		37.95
20144342051	40 cl		13.30



Teesieb schwarz Passe-thé noir

20144041051	5,5 cm x H 5 cm		20.35
-------------	-----------------	--	-------



Cremier Crémier

20144604051	4 cl		11.45
-------------	------	--	-------



Milchkanne Pot à lait

20144715051	15 cl		21.70
20144730051	30 cl		28.75



Eierbecher mit Ablage Coquetier avec rangement

20144000051	Ø 12,9 cm		9.85
-------------	-----------	--	------



Espresso-Tasse Tasse à espresso

20145159051	9 cl		9.85
<i>passend: Espresso-Untertasse, Untertasse mit 2 Spiegel, Deckel 9 cl</i>			
<i>compatible: Soutasse à espresso, soutasse avec 2 maris, couvercle 9 cl</i>			



Espressotasse stapelbar Tasse à espresso empilable

20145209051	9 cl		10.60
-------------	------	--	-------



Kaffee-Tasse Tasse à café

20145169051	19 cl		12.50
<i>passend: Kombi-Untertasse, Deckel 19 cl</i>			
<i>compatible: Soutasse multiple, couvercle 19 cl</i>			



Kaffee-Tasse Tasse à café

20145172051	22 cl		13.30
<i>passend: Kombi-Untertasse</i>			
<i>compatible: Soutasse multiple</i>			



Kaffee-Tasse Tasse à café

20145176051	26 cl		13.30
<i>passend: Kombi-Untertasse</i>			
<i>compatible: Soutasse multiple</i>			



Kaffee-Tasse Tasse à café

20145185051	35 cl		16.75
<i>passend: Untertasse mit 2 Spiegel</i>			
<i>compatible: Soutasse avec 2 maris</i>			



Mug Gobelet

20145635051	35 cl		16.75
<i>passend: Kombi-Untertasse</i>			
<i>compatible: Soutasse multiple</i>			



Kaffee-Tasse stapelbar Tasse à café empilable

20145119051	19 cl		12.50
<i>passend: Kombi-Untertasse</i>			
<i>compatible: Soutasse multiple</i>			



Kaffee-Tasse stapelbar Tasse à café empilable

20145122051	22 cl		13.30
<i>passend: Kombi-Untertasse</i>			
<i>compatible: Soutasse multiple</i>			



purity



Tasse Glockenform
Tasse évasée

20145322051 22 cl 12.25



Tee-Tasse
Tasse à thé

20145174051 24 cl 13.30

passend: Untertasse mit 2 Spiegel
compatible: Soutasse avec 2 marlis



Suppentasse
Tasse à consommé

20142777051 27 cl 16.75

passend: Deckel 27 cl, Untertasse mit 2 Spiegel
compatible: couvercle 27 cl, soutasse avec 2 marlis



Suppentasse
Tasse à consommé

20142885051 35 cl 16.75



Bowl
Bol

20146707051 7 cl 8.65



Bowl
Bol

20146559051 9 cl 9.55

passend: Espresso-Untertasse, Untertasse mit 2 Spiegel, Deckel 9 cl
compatible: Soutasse à espresso, soutasse avec 2 marlis, couvercle 9 cl



Bowl
Bol

20146569051 19 cl 11.45

passend: Deckel 19 cl, Kombi-Untertasse
compatible: couvercle 19 cl, soutasse multiple



Bowl
Bol

20146577051 27 cl 13.30

passend: Deckel 27 cl, Untertasse mit 2 Spiegel
compatible: couvercle 27 cl, soutasse avec 2 marlis



Bowl
Bol

20146595051 45 cl 18.60

passend: Teller flach Fahne rund Ø 17 cm
compatible: Assiette plate rond bord Ø 17 cm



Deckel
Couvercle

20146409051 9 cl 8.65

20146419051 19 cl 11.45

20146427051 27 cl 13.30



Espresso-Untertasse
Soutasse espresso

20146909051 Ø 13,5 cm 7.15



Kombi-Untertasse
Soutasse multiple

20146919051 Ø 16 cm 8.65



Untertasse mit 2 Spiegel
Soutasse avec 2 marlis

20147135051 Ø 16,5 cm 8.65



Untertasse coup mit 2 Spiegel
Soutasse coupe avec 2 marlis

20146819051 Ø 16 cm 8.65



Untertasse 2 Spiegel
Soutasse avec 2 marlis

20147144051 21 cm 13.30



Teller flach rund Fahne
Assiette plate rond bord

20140017051	Ø 17 cm			9.85
20140022051	Ø 22 cm			13.30
20140024051	Ø 24 cm			16.75
20140026051	Ø 26 cm			22.60
20140029051	Ø 29 cm			29.30
20140032051	Ø 32 cm			34.90



Systemteller
Assiette système

20140825051	25,7 cm			22.60
-------------	---------	--	--	-------



Teller flach coup
Assiette plate coupe

20141216051	Ø 16 cm			9.85
20141221051	Ø 21 cm			13.30
20141224051	Ø 24 cm			18.60
20141227051	Ø 27 cm			22.60
20141229051	Ø 29 cm			29.30
20141231051	Ø 31 cm			34.90



Teller tief rund Fahne
Assiette creuse rond bord

20140120051	Ø 20 cm			13.30
20140124051	Ø 24 cm			21.70
20140129051	Ø 29 cm			28.75



Teller tief coup
Assiette creuse coupe

20141320051	Ø 20 cm			13.30
20141324051	Ø 24 cm			21.70
20141329051	Ø 29 cm			28.75



Teller flach coup stapelbar
Assiette plate coupe empilable

20141925051	25 cm			22.60
-------------	-------	--	--	-------



Teller flach quadratisch coup
Assiette plate carrée coupe

20141509051	9 x 9 cm			8.65
201411520051	20 x 20 cm			13.30
20141527051	27 x 27 cm			26.60



Platte oval Fahne
Plat oval bord

20142018051	18 (17,9 x 13,1 cm)			20.35
20142024051	24 (23,7 x 17,5 cm)			29.30
20142033051	33 (33,0 x 24,4 cm)			46.60
20142038051	38 (37,9 x 27,8 cm)			58.60



Platte oval coup
Plat ovale coupe

20142212051	12 cm			11.45
20142233051	33 x 24 cm			43.95
20142237051	37 x 27 cm			53.15



Platte rechteckig coup
Plat rectangulaire coupe

20142318051	18 x 9 cm			13.30
-------------	-----------	--	--	-------



Platte rechteckig coup
Plat rectangulaire coupe

20142320051	20 x 15 cm			18.60
-------------	------------	--	--	-------



Platte rechteckig coup
Plat rectangulaire coupe

20142327051	27 x 20 cm			34.90
20142334051	34 x 20 cm			46.60
20142342051	42 x 20 cm			61.30



purity



block
buster



Schale rund
Saladier rond

20145708051	10 cl / Ø 8 cm			9.85
20145711051	22 cl / Ø 11 cm			13.30
20145714051	42 cl / Ø 14 cm			18.60
20145716051	75 cl / Ø 16 cm			24.75
20145719051	110 cl / Ø 19 cm			37.95
20145722051	170 cl / Ø 22 cm			55.95
20145725051	280 cl / Ø 25 cm			75.95



Schale oval
Saladier ovale

20146212051	18 cl / 12 cm			11.45
-------------	---------------	--	--	-------

passend: Deckel oval 12 cm, Platte oval Fahne 18 cm
compatible: couvercle oval 12 cm, plate oval bord 18 cm



Schale oval
Saladier ovale

20146216051	50 cl / 16 cm			18.60
-------------	---------------	--	--	-------

passend: Deckel oval 16 cm, Platte oval Fahne 24 cm
compatible: couvercle oval 16 cm, plate oval bord 24 cm



Deckel oval
Couvercle ovale

20146312051	12 cm			13.30
20146316051	16 cm			20.35



Schale coup
Coupelle coup

20146107051	5 cl / 7 cm			9.55
-------------	-------------	--	--	------



Schale coup
Bol coup

20146113051	13 cm			17.30
-------------	-------	--	--	-------

passend: Untertasse 2 Spiegel 21 cm, Deckel zu Schale coup
compatible: Soutasse avec 2 maris 21 cm, Couvercle pour coupelle coup



Deckel zu Schale coup
Couvercle pour bol coup

20146444051	13 cm			13.30
-------------	-------	--	--	-------



Schale coup
Bol coup

20146120051	20 cm			26.60
-------------	-------	--	--	-------



Schale asymmetrisch
Bol asymétrique

20143367051	17 cm			22.60
-------------	-------	--	--	-------

passend: Untertasse 2 Spiegel 21 cm
compatible: Soutasse avec 2 maris 21 cm



Schale asymmetrisch
Bol asymétrique

20143375051	25 cm			31.95
-------------	-------	--	--	-------



Sauciere
Saucière

20143810051	10 cl			13.30
-------------	-------	--	--	-------

passend: Platte oval Fahne 18 cm
compatible: plate oval bord 18 cm



Sauciere
Saucière

20143835051	35 cl			28.75
-------------	-------	--	--	-------

passend: Platte oval Fahne 24 cm
compatible: plate oval bord 24 cm



Salzstreuer
Salière

20144010051	5,1 x 3,8 x H 8,7 cm			19.95
-------------	----------------------	--	--	-------



Pfefferstreuer
Poivrier

20144020051	5,1 x 3,8 x H 8,7 cm			19.95
-------------	----------------------	--	--	-------





Vase
Vase

20148100051 6,3 x 4,8 x H 13 cm   17.30





Ascher
Cendrier

20147500051 8,4 x H 3,3 cm   10.60







Zahnstocher/-Zuckersticksbehälter
Boîte de cure-dents/sucrier

20144090051 5,1 x 3,8 cm x H 5 cm   7.55





Etagere 1er rund*
Etagère ronde 1 étage*



20147801051 Stab versilbert** | Tige argenté**
H 16,6 cm   34.90

20147201051 Etagerteller rund | Assiette pour étagère
Ø 22 cm   26.60



Etagere 2er rund*
Etagère ronde 2 étages*

20147802051 Stab versilbert** | Tige argenté**
H 24,8 cm   38.60



20147201051 Etagerteller rund | Assiette pour étagère
Ø 22 cm   26.60

20147202051 Etagerteller rund | Assiette pour étagère
Ø 29 cm   41.95



Etagere 3er oval*
Etagère ovale 3 étages*

20147803051 Stab versilbert** | Tige argenté**
H 31,0 cm   46.60

20147203051 Etagerteller oval | Assiette pour étagère oval
Ø 24 cm   38.60

20147204051 Etagerteller oval | Assiette pour étagère oval
Ø 33 cm   61.30

20147205051 Etagerteller oval | Assiette pour étagère oval
Ø 38 cm   75.95

* Die Etageren werden in Einzelteilen mit Montageanleitung geliefert.

Les étagères sont livrées en pièces détachées avec une notice de montage.

** Alle Stäbe der Etageren sind nicht spülmaschinengeeignet und sollten nur mit einem feuchten Tuch gereinigt und trocken nachgewischt werden. Bitte daher die Etageren zum Spülen auseinanderbauen. Toutes les tiges des étagères ne sont pas adaptées au lave-vaisselle. Pour le nettoyage, veuillez s.v.p., démonter le support central. Les éléments doivent être nettoyés séparément avec un chiffon humide, puis séchés.

Pure Eleganz.

L'élégance à l'état pur

Bauscher erfindet das Porzellan neu. Mit einer klaren ästhetischen Aussage in einer anmutigen neuen Materialität hat Purity alle Qualitäten, ein moderner Klassiker zu werden. Dabei gehen strenge Grundformen wie Kreis und Oval eine spannungsvolle Verbindung mit fließend weichen Linien ein. In diesem Wechselspiel entfaltet die Form einen reizvoll sinnlichen Charme, der sie zum Favoriten internationaler First-Class-Adressen macht. Purity überzeugt in ganz unterschiedlich eleganten Interior-Welten stets mit souveräner Präsenz.

- Filigraner Scherben aus revolutionärem Hartporzellan Noble China
- Edler neuer Farbton Bonewhite
- Kantenschlagfestigkeit, die neue Massstäbe setzt
- Extrem harte und widerstandsfähige Glasur
- Spülmaschinenfeste Inglasurdekore
- Unvergleichliche Qualität Made in Germany
- Umfassendes, multifunktional kombinierbares Sortiment
- Souveräne Präsenz in unterschiedlichen Stilwelten

Bauscher réinvente la porcelaine. Expression de la clarté et de l'harmonie dans une nouvelle matérialité légère, Purity rassemble toutes les qualités pour devenir un classique moderne. Ainsi, des formes basiques sobres comme le cercle ou l'ovale rencontrent des lignes fluides et douces, créant une association fascinante. Ce contraste confère aux formes un charme délicat et séduisant qui fait de cette collection la favorite des établissements haut de gamme à travers le monde. La collection Purity s'intègre parfaitement dans des intérieurs très différents, toujours avec une grande prestance.

- Corps filigrane d'une porcelaine dure révolutionnaire « Noble China »
- Nouveau coloris noble « Bonewhite »
- Résistance aux chocs inégalée au niveau des bords
- Dureté de surfaces et résistance aux rayures extraordinaires
- Décorations sur porcelaine résistant au passage au lave-vaisselle
- Fabrication allemande, pour une qualité incomparable
- Gamme complète, multifonctionnelle et modulable
- Grande prestance dans différents styles



purity dekore/décors





Blooming Shades

Finest Loom



Finest Loom vollfond

dekore/décors



**Kaffeekanne komplett**
Cafetière complète

20144130737 Blooming Shades 30 cl   66.60





**Teekanne komplett**
Théière complète

20144340737 Blooming Shades 40 cl   75.95



**Cremier**
Crémier

20144604737 Blooming Shades 4 cl   19.95



**Milchkanne**
Pot à lait

20144715737 Blooming Shades 15 cl   36.65
20144730737 35 cl   51.95

**Eierbecher mit Ablage**
Coquetier avec rangement

20144000737 Blooming Shades Ø 12,9 cm   15.85



**Espresso-Tasse**
Tasse à espresso

20145159737 Blooming Shades 9 cl   17.30
passend: Espresso-Untertasse, Deckel 9 cl
compatible: Soutasse à espresso, couvercle 9 cl

**Kaffee-Tasse**
Tasse à café

20145169737 Blooming Shades 19 cl   20.35
passend: Kombi-Untertasse, Deckel 19 cl
compatible: Soutasse multiple, couvercle 19 cl



**Kaffee-Tasse**
Tasse à café

20145172737 Blooming Shades 22 cl   22.60
passend: Kombi-Untertasse
compatible: Soutasse multiple



**Kaffee-Tasse**
Tasse à café

20145176737 Blooming Shades 26 cl   22.60
passend: Kombi-Untertasse
compatible: Soutasse multiple

**Kaffee-Tasse**
Tasse à café

20145185737 Blooming Shades 35 cl   26.60
passend: Untertasse mit 2 Spiegel
compatible: Soutasse avec 2 maris

**Kaffee-Tasse stapelbar**
Tasse à café empilable



20145119737 Blooming Shades 19 cl   20.35
passend: Kombi-Untertasse
compatible: Soutasse multiple

**Kaffee-Tasse stapelbar**
Tasse à café empilable



20145122737 Blooming Shades 22 cl   22.60
passend: Kombi-Untertasse
compatible: Soutasse multiple

purity dekore/décors



**Mug**
Gobelet

20145635737 **Blooming Shades**
35 cl   26.60
passend: Kombi-Untertasse
compatible: Soutasse multiple



**Tee-Tasse**
Tasse à thé



20145174737 **Blooming Shades**
24 cl   22.60
passend: Untertasse mit 2 Spiegel
compatible: Soutasse avec 2 marlis

**Suppentasse**
Tasse à consommé



20142777737 **Blooming Shades**
27 cl   26.60
passend: Deckel 27 cl, Untertasse mit 2 Spiegel
compatible: couvercle 27 cl, soutasse avec 2 marlis



**Bowl**
Bol

20146559737 **Blooming Shades**
9 cl   13.30



20146559247 **Finest Loom**
9 cl   13.30
passend: Deckel 9 cl, Espresso-Untertasse
compatible: couvercle 9 cl, soutasse à espresso



**Bowl**
Bol

20146569737 **Blooming Shades**
19 cl   18.60



20146569247 **Finest Loom**
19 cl   18.60
passend: Deckel 19 cl, Kombi-Untertasse
compatible: couvercle 19 cl, soutasse multiple



**Bowl**
Bol

20146577737 **Blooming Shades**
27 cl   24.75



20146577247 **Finest Loom**
27 cl   24.75
passend: Deckel 27 cl, Untertasse mit 2 Spiegel
compatible: couvercle 27 cl, soutasse avec 2 marlis



**Bowl**
Bol

20146595737 **Blooming Shades**
45 cl   31.95



20146595247 **Finest Loom**
45 cl   31.95
passend: Teller flach Fahne rund Ø 17 cm
compatible: Assiette plate rond bord Ø 17 cm



**Espresso-Untertasse**
Soutasse espresso

20146909737 **Blooming Shades**
Ø 13,5 cm   11.95



20146909247 **Finest Loom**
Ø 13,5 cm   11.95



**Kombi-Untertasse**
Soutasse multiple

20146919737 **Blooming Shades**
Ø 16 cm   13.30

20146919247 **Finest Loom**
Ø 16 cm   13.30

**Untertasse mit 2 Spiegel**
Soutasse avec 2 marlis

20147135737 **Blooming Shades**
Ø 16,5 cm   13.30

20147135247 **Finest Loom**
Ø 16,5 cm   13.30



purity dekore/décors



Teller flach rund Fahne
Assiette plate rond bord

Blooming Shades

20140017737	Ø 17 cm			20.35
20140022737	Ø 22 cm			29.30
20140024737	Ø 24 cm			32.75
20140026737	Ø 26 cm			37.95
20140029737	Ø 29 cm			46.60
20140032737	Ø 32 cm			58.60

Finest Loom

20140017247	Ø 17 cm			20.35
20140022247	Ø 22 cm			29.30
20140024247	Ø 24 cm			32.75
20140026247	Ø 26 cm			37.95
20140029247	Ø 29 cm			46.60
20140032247	Ø 32 cm			58.60

Finest Loom vollfond

20140017246	Ø 17 cm			29.30
20140032246	Ø 32 cm			65.30



Teller tief rund Fahne
Assiette creuse rond bord

Blooming Shades

20140120737	Ø 20 cm			24.75
20140124737	Ø 24 cm			34.90
20140129737	Ø 29 cm			49.95

Finest Loom

20140120247	Ø 20 cm			24.75
20140124247	Ø 24 cm			34.90
20140129247	Ø 29 cm			49.95



Teller flach coup
Assiette plate coupe

Finest Loom

20141216246	Ø 16 cm			13.30
20141221246	Ø 21 cm			24.75
20141224246	Ø 24 cm			31.95
20141227246	Ø 27 cm			38.60
20141229246	Ø 29 cm			46.60
20141231246	Ø 31 cm			53.15



Platte oval Fahne
Plat oval bord

Blooming Shades

20142018737	18 (17,9 x 13,1 cm)			31.95
20142024737	24 (23,7 x 17,5 cm)			49.95
20142033737	33 (33,0 x 24,4 cm)			75.95
20142038737	38 (37,9 x 27,8 cm)			91.95

Finest Loom

20142018247	18 (17,9 x 13,1 cm)			31.95
20142024247	24 (23,7 x 17,5 cm)			49.95
20142033247	33 (33,0 x 24,4 cm)			75.95
20142038247	38 (37,9 x 27,8 cm)			91.95



Schale rund
Saladier rond

Blooming Shades

20145708737	10 cl / Ø 8 cm			19.95
20145711737	22 cl / Ø 11 cm			22.60
20145716737	75 cl / Ø 16 cm			43.95
20145719737	110 cl / Ø 19 cm			63.95
20145722737	170 cl / Ø 22 cm			99.85

Finest Loom

20145708247	10 cl / Ø 8 cm			19.95
20145711247	22 cl / Ø 11 cm			22.60
20145716247	75 cl / Ø 16 cm			43.95
20145719247	110 cl / Ø 19 cm			63.95
20145722247	170 cl / Ø 22 cm			99.85



Schale oval
Saladier ovale

Blooming Shades

20146212737	18 cl / 12 cm			19.95
-------------	---------------	--	--	-------

Finest Loom

20146212247	18 cl / 12 cm			19.95
-------------	---------------	--	--	-------

*passend: Deckel oval 12 cm, Platte oval Fahne 18 cm
compatible: couvercle oval 12 cm, plate oval bord 18 cm*



Schale oval
Saladier ovale

Blooming Shades

20146216737	50 cl / 16 cm			31.95
-------------	---------------	--	--	-------

Finest Loom

20146216247	50 cl / 16 cm			31.95
-------------	---------------	--	--	-------

*passend: Deckel oval 16 cm, Platte oval Fahne 24 cm
compatible: couvercle oval 16 cm, plate oval bord 24 cm*

purity dekore/décors

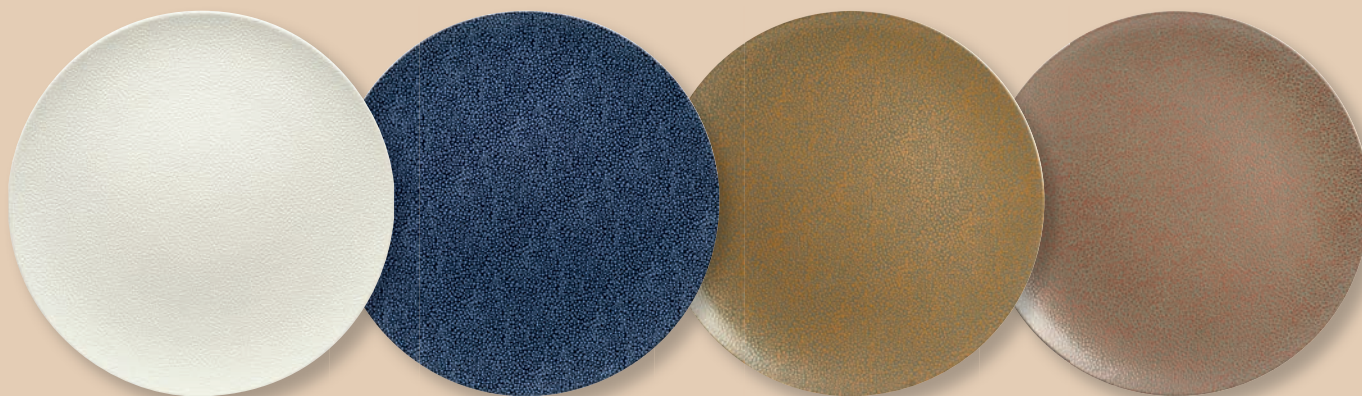

Pearls Light

Pearls Dark

Pearls Metallic Gold

Pearls Metallic Copper



Teller flach coup
Assiette plate coupe

Pearls Light

20141216440	Ø 16 cm			13.30
20141221440	Ø 21 cm			24.75
20141224440	Ø 24 cm			31.95
20141227440	Ø 27 cm			38.60
20141229440	Ø 29 cm			46.60
20141231440	Ø 31 cm			53.15



Teller tief coup
Assiette creuse coupe

Pearls Light

20141324440	Ø 24 cm			34.90
20141329440	Ø 29 cm			46.60
Pearls Dark				
20141324439	Ø 24 cm			34.90
20141329439	Ø 29 cm			46.60

Pearls Metallic Gold

20141324693	Ø 24 cm			34.90
20141329693	Ø 29 cm			46.60

Pearls Metallic Copper

20141324694	Ø 24 cm			34.90
20141329694	Ø 29 cm			46.60



Teller flach coup
Assiette plate coupe

Pearls Dark

20141216439	Ø 16 cm			13.30
20141221439	Ø 21 cm			24.75
20141224439	Ø 24 cm			31.95
20141227439	Ø 27 cm			38.60
20141229439	Ø 29 cm			46.60
20141231439	Ø 31 cm			53.15



Platte oval coup
Plat ovale coupe

Pearls Light

20142233440	33 x 24 cm			72.50
20142237440	37 x 27 cm			86.35

Pearls Dark

20142233439	33 x 24 cm			72.50
20142237439	37 x 27 cm			86.35

Pearls Metallic Gold

20142233693	33 x 24 cm			72.50
20142237693	37 x 27 cm			86.35

Pearls Metallic Copper

20142233694	33 x 24 cm			72.50
20142237694	37 x 27 cm			86.35



Teller flach coup
Assiette plate coupe

Pearls Metallic Gold

20141216693	Ø 16 cm			13.30
20141221693	Ø 21 cm			24.75
20141224693	Ø 24 cm			31.95
20141227693	Ø 27 cm			38.60
20141229693	Ø 29 cm			46.60
20141231693	Ø 31 cm			53.15



Teller flach coup
Assiette plate coupe

Pearls Metallic Copper

20141216694	Ø 16 cm			13.30
20141221694	Ø 21 cm			24.75
20141224694	Ø 24 cm			31.95
20141227694	Ø 27 cm			38.60
20141229694	Ø 29 cm			46.60
20141231694	Ø 31 cm			53.15

Weitere Dekore auf Anfrage
Plusieurs décors sur demande



Classic Gold



Noblesse Gold



Terrazzo

Die Dekore Purity Pearls sind auf Anfrage auch auf allen Artikeln von Purity Square erhältlich.
Les décors Purity Pearls ainsi que tous les articles de Purity Square sont disponibles sur demande.



purity dekore/décors



① Fine Ornaments No. 1 ③ Fine Ornaments No. 3
② Fine Ornaments No. 2 ④ Fine Ornaments No. 4



⑤ Art Deco
⑥ Natural

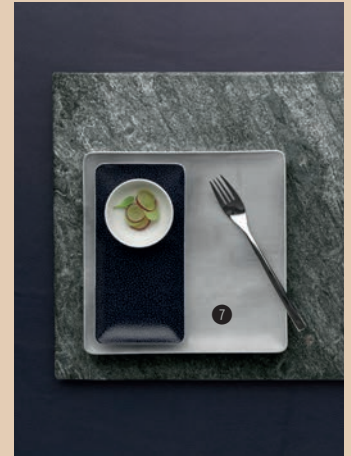

⑦ Soft Gray



Platte rechteckig coup
Plat rectangulaire coupe

20142318644	Fine Ornaments Nr 01 18 x 9 cm		22.60
20142318645	Fine Ornaments Nr 02 18 x 9 cm		22.60
20142318643	Fine Ornaments Nr 03 18 x 9 cm		22.60
20142318642	Fine Ornaments Nr 04 18 x 9 cm		22.60
20142318617	Art Deco 18 x 9 cm		22.60
20142318641	Soft Gray 18 x 9 cm		22.60
20142318616	Natural 18 x 9 cm		22.60



Teller flach quadratisch coup
Assiette plate carrée coupe

20141509644	Fine Ornaments Nr 01 9 x 9 cm		13.30
20141509645	Fine Ornaments Nr 02 9 x 9 cm		13.30
20141509643	Fine Ornaments Nr 03 9 x 9 cm		13.30
20141509642	Fine Ornaments Nr 04 9 x 9 cm		13.30
20141509617	Art Deco 9 x 9 cm		13.30
20141509641	Soft Gray 9 x 9 cm		13.30
20141509616	Natural 9 x 9 cm		13.30



Platte rechteckig coup
Plat rectangulaire coupe

20142320644	Fine Ornaments Nr 01 20 x 15 cm		31.95
20142320645	Fine Ornaments Nr 02 20 x 15 cm		31.95
20142320643	Fine Ornaments Nr 03 20 x 15 cm		31.95
20142320642	Fine Ornaments Nr 04 20 x 15 cm		31.95
20142320617	Art Deco 20 x 15 cm		31.95
20142320641	Soft Gray 20 x 15 cm		31.95
20142320616	Natural 20 x 15 cm		31.95



Teller flach quadratisch coup
Assiette plate carrée coupe

20141520641	Soft Gray 20 x 20 cm		22.60
20141527641	Soft Gray 27 x 27 cm		38.60
20141520616	Natural 20 x 20 cm		22.60
20141527616	Natural 27 x 27 cm		38.60



Platte rechteckig coup
Plat rectangulaire coupe

20142327641	Soft Gray 27 x 20 cm		53.15
20142334641	Soft Gray 34 x 20 cm		75.95
20142342641	Soft Gray 42 x 20 cm		99.85
20142327616	Natural 27 x 20 cm		53.15
20142334616	Natural 34 x 20 cm		75.95
20142342616	Natural 42 x 20 cm		99.85

Die Dekore Soft Gray und Natural sind auf Anfrage auch auf allen Artikeln von Purity Coup erhältlich
Les décors Soft Gray et Natural ainsi que tous les articles de Purity Coup sont disponibles sur demande.

antique style



Teller flach coup
Assiette plate coupe

- | | | | |
|-------------|-----------------------------|--|-------|
| 20141224731 | Antique Cinnamon
Ø 24 cm | | 31.95 |
| 20141224733 | Anique Sea Salt
Ø 24 cm | | 31.95 |
| 20141227733 | Ø 27 cm | | 38.60 |
| 20141224734 | Antique Mokka
Ø 24 cm | | 31.95 |
| 20141227734 | Ø 27 cm | | 38.60 |
| 20141224735 | Antique Olive
Ø 24 cm | | 31.95 |



Platte rechteckig coup
Plat rectangulaire coupe

- | | | | |
|-------------|------------------------------------|--|-------|
| 20142320732 | Antique White Pepper
20 x 15 cm | | 31.95 |
| 20142320733 | Anique Sea Salt
20 x 15 cm | | 31.95 |
| 20142320734 | Antique Mokka
20 x 15 cm | | 31.95 |



Teller tief coup
Assiette creuse coupe

- | | | | |
|-------------|---------------------------------|--|-------|
| 20141324732 | Antique White Pepper
Ø 24 cm | | 34.90 |
| 20141324735 | Antique Olive
Ø 24 cm | | 34.90 |

Weitere Artikel auf Anfrage.
Plusieurs articles sur demande.



1 Antique Cinnamon
2 Antique White Pepper



3 Antique Sea Salt



4 Antique Mokka



5 Antique Olive



purity dekore/décors

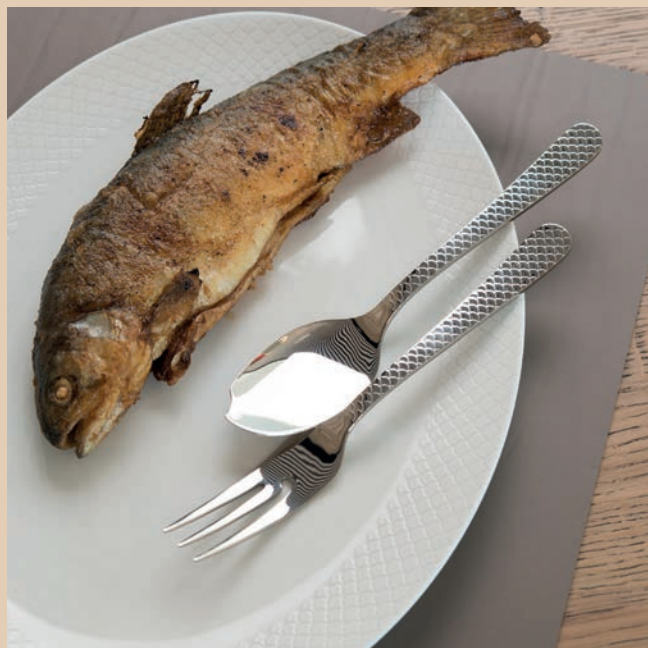

pescado & laguna

Exklusives Design nur erhältlich bei Berndorf Luzern.

Design exclusif uniquement disponible chez Berndorf Luzern.



PESCADO
Platte oval coup
Plat oval coup

20142233322 33 x 24 cm

65.30



LAGUNA
Platte oval coup
Plat oval coup

20142233312 33 x 24 cm

65.30



Das passende Besteck finden Sie im Kapitel Besteck Seite 210.

Vous trouverez les couverts qui vous conviennent au chapitre Couverts, page 210.

purity & playground



Kombinieren Sie Purity mit den ausgefallenen Artikel und Accessoires aus dem Playground-Katalog. Playground ist ein bewegliches, offenes Sortiment mit regelmässigen Updates, das die aktuellsten Trends der Speisenpräsentation für Sie zusammenstellt. Guten Appetit!

Associez Purity aux articles et accessoires originaux du catalogue Playground. Playground est une gamme ouverte et évolutive avec des mises à jour régulières, qui réunit pour vous les dernières tendances en matière de présentation des plats. Bon appétit!

www.berndorf.ch





BAUSCHER
GERMANY

raffinesse

Mit raffinierter Formenvielfalt der perfekte Begleiter für den kulinarischen Tag. Die Serie Raffinesse bietet eine wunderschöne Bühne für Ihre Kunst.

Avec une diversité de formes raffinées, le compagnon parfait tout au long de la journée culinaire. La série Raffinesse offre une scène magnifique à votre art de cuisine.



Kaffeekanne komplett
Cafetière complète

22000030051	30 cl		37.95
	Kaffeekanne Unterteil Cafetière corps		
22000031051	30 cl		31.45
	Kaffeekanne Deckel Cafetière couvercle		
22000003051	30 cl		11.95



Espresso-Tasse
Tasse à espresso

22013009051	9 cl		9.30
-------------	------	--	------



Espresso-Untertasse
Soutasse à espresso

22013090051	Ø 13,4 cm		6.35
-------------	-----------	--	------



Teekanne komplett
Théière complète

22000050051	50 cl		45.30
	Teekanne Unterteil Théière corps		
22000051051	50 cl		34.45
	Teekanne Deckel Théière couvercle		
22000005051	50 cl		13.30



Kaffee-Tasse
Tasse à café

22013018051	18 cl		11.95
22013022051	22 cl		12.75



Teesieb Kunststoff
Filtre plastique

418132300	Ø 7,5 cm x H 7,7 cm		22.60
-----------	---------------------	--	-------



Tee-Tasse
Tasse à thé

22013028051	28 cl		13.30
-------------	-------	--	-------



Teesiebablage
Support pour filtre

22054000051	Ø 8,3 cm x H 10,9 cm		13.30
-------------	----------------------	--	-------



Kaffee-Tasse stapelbar
Tasse à café empilable

22010018051	18 cl		11.15
-------------	-------	--	-------



Milchkanne
Pot à lait

22000015051	15 cl		16.75
22004730051	30 cl		28.25



Kaffee-Tasse stapelbar
Tasse à café empilable

22005222051	22 cl		12.75
-------------	-------	--	-------



Zuckerdose komplett
Sucrier complet

22005023051	23 cl		25.30
	Zuckerdose Unterteil Sucrier corps		
22004924051	23 cl		16.75
	Zuckerdose Deckel Sucrier couvercle		
22005032051	23 cl		9.30



Kombi-Untertasse
Soutasse multiple

22013081051	18/22/28 cl / Ø 16,2 cm		8.35
-------------	-------------------------	--	------



raffinesse



Café au Lait-Tasse
Tasse de café au lait

22013040051 40 cl 17.30



Becher mit Henkel
Gobelet avec anse

22027030051 31 cl 13.30



Untertasse
Soutasse

22013400051 31/40 cl / Ø 19,0 cm 9.85



Suppen-Tasse mit Griffen stapelbar
Tasse à consommé avec poignées empilable

22056027051 28 cl 18.35



Kombi-Untertasse
Soutasse multiple

22013081051 18/22/28 cl / Ø 16,2 cm 8.35



Bowl
Bol

22058028051 28 cl / Ø 10,8 cm 13.30
22058040051 40 cl / Ø 12,2 cm 16.50



Teller flach rund
Assiette plate ronde

22051016051 Ø 15,8 cm 7.30
22051021051 Ø 20,9 cm 13.30
22051026051 Ø 25,8 cm 21.05
22051029051 Ø 29,0 cm 26.60
22051032051 Ø 31,3 cm 31.45



Teller flach rund asymetrische Fahne
Assiette plate ronde asymétrique

20081816051 Ø 16,1 cm 8.35



Teller flach coup Raute
Assiette plate coupe rhombique

22052016051 16,6 x 11,2 cm 12.75
22052034051 34,0 x 23,7 cm 36.65



Teller tief rund
Assiette creuse ronde

22051061051 Ø 16,4 cm 9.30
22051042051 Ø 23,9 cm 19.95
22051082051 Ø 27,8 cm 28.25



Platte oval Fahne
Plat ovale bord

20082032051 33,0 x 22,7 cm 38.60



Schale rund
Coupe ronde

20085722051 50 cl / 23,0 x 21,4 cm 31.45



Schale Raute
Ravier rhombique

22087010051 10,3 x 7,8 cm 9.85
22087016051 16,0 x 12,0 cm 16.75





Sauciere
Saucière

22077010051 10 cl  19.95

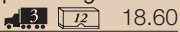

Etagere 2er rund*
Etagère ronde 2 étages*

20147802051 Stab versilbert** | Tige argenté**
H 24,8 cm  38.60
22053021051 Etagerteller rund | Assiette pour étagère rond
21 cm  18.60
22053026051 26 cm  29.55

* Die Etageren werden in Einzelteilen mit Montageanleitung geliefert.
Les étagères sont livrées en pièces détachées avec une notice de montage.

** Alle Stäbe der Etageren sind nicht spülmaschinengeeignet und sollten nur mit einem feuchten Tuch gereinigt und trocken nachgewischt werden. Bitte daher die Etageren zum Spülen auseinanderbauen.
Toutes les tiges des étagères ne sont pas adaptées au lave-vaisselle. Pour le nettoyage, veuillez s.v.p., démonter le support central. Les éléments doivent être nettoyés séparément avec un chiffon humide, puis séchés.

dekore/décors

Preise auf Anfrage
Prixes sur demande



doré







BAUSCHER
GERMANY



scope



Scope besticht durch entscheidende Einfachheit. Mit angenehmer Schlichtheit variiert Scope mit einer grossen Bandbreite an pur weissen und zart farbig glasierten Artikeln.

La série Scope impressionne par sa simplicité décisive. Scope avec son aisance agréable vous offre une large gamme d'articles en pur blanc ou délicatement colorés.











 **Espresso-Tasse**
Tasse à espresso
glatt
27352590051 9 cl   9.30







 **Schale**
Coupelle
glatt
27361080051 6 cl   7.05

 **Espresso-Untertasse**
Soutasse à espresso
glatt
27369590051 9 cl / Ø 12 cm   5.85

 **Teller flach coup**
Assiette plate coupe
glatt
27312650051 Ø 15 cm   7.05
27312700051 Ø 20 cm   11.15
27312760051 Ø 26 cm   19.95
27312780051 Ø 28 cm   22.10
27312820051 Ø 32 cm   29.30





 **Kaffee-Tasse**
Tasse à café
glatt
27351680051 18 cl   9.85



 **Teller tief coup**
Assiette creuse coupe
glatt
27313740051 Ø 24 cm   19.95
27313790051 Ø 29 cm   25.30







 **Tasse nieder**
Tasse basse
glatt
27351720051 22 cl   11.15
27351780051 28 cl   12.75
27351850051 35 cl   13.30

 **Schale**
Bol
glatt
27361620051 Ø 12 cm   9.85
27361660051 Ø 16 cm   15.55



 **Becher**
Mug
glatt
27355320051 32 cl   13.30



 **Schale**
Bol
glatt
27361690051 Ø 19 cm   19.95
27361730051 Ø 23 cm   28.25

 **Kombi-Untertasse**
Soutasse combi
glatt
27369800051 18-35 cl / Ø 16,5 cm   7.30

 **Platte oval coup**
Plat ovale coupe
glatt
27322730051 23 x 15 cm   22.60
27322820051 32 x 19 cm   34.45
27322870051 37 x 22 cm   41.95

 **Bowl**
Bol
glatt
27365950051 45 cl   15.55

 **Untertasse zu Bowl 45 cl**
Soutasse pour bol 45 cl
glatt
27369950051 Ø 19 cm   9.30



 **Platte oval coup**
Plat ovale coupe
glatt
27322960051 46 x 18 cm   55.95

scope linea



Espresso-Untertasse
Soutasse à espresso

linea

27369590015 9 cl / Ø 12 cm   5.85



Kombi-Untertasse
Soutasse combi

linea

27369800015 18-35 cl / Ø 16,5 cm   7.30



Bowl
Bol

linea

27365450015 45 cl   15.55



Untertasse zu Bowl 45 cl
Soutasse pour bol 45 cl











linea

27369950015 Ø 19 cm   9.30



Teller flach coup
Assiette plate coupe

linea

27312650015 Ø 15 cm   7.05
27312700015 Ø 20 cm   11.15
27312760015 Ø 26 cm   19.95
27312780015 Ø 28 cm   23.95
27312820015 Ø 32 cm   31.45



Teller tief coup
Assiette creuse coupe

linea

27313740015 Ø 24 cm   19.95
27313790015 Ø 29 cm   25.30



Schale
Bol

linea

27361620015 Ø 12 cm   9.85
27361660015 Ø 16 cm   15.55



Schale
Bol



linea

27361690015 Ø 19 cm   19.95
27361730015 Ø 23 cm   28.25



Platte oval coup
Plat ovale coupe

linea

27322730015 23 x 15 cm   22.60
27322820015 32 x 19 cm   34.45
27322870015 37 x 22 cm   41.95



Platte oval coup
Plat ovale coupe

linea



27322960015 46 x 18 cm   55.95











scope glow gray









 **Espresso-Tasse**
Tasse à espresso
glow gray
27352590020 9 cl   9.85



 **Espresso-Untertasse**
Soutasse à espresso
glow gray
27369590020 9 cl / Ø 12 cm   6.35



 **Kaffee-Tasse**
Tasse à café
glow gray
27351680020 18 cl   12.75

 **Tasse nieder**
Tasse basse
glow gray
27351720020 22 cl   13.30
27351780020 28 cl   15.55
27351850020 35 cl   16.75





 **Becher**
Mug
glow gray
27355320020 32 cl   15.55





 **Kombi-Untertasse**
Soutasse combi
relief glow gray
27369800020 18-35 cl / Ø 16,5 cm   8.35





 **Bowl**
Bol
relief glow gray
27365450020 45 cl   18.35







 **Untertasse zu Bowl 45 cl**
Soutasse pour bol 45 cl
relief glow gray
27369950020 Ø 19 cm   9.85



 **Teller flach coup**
Assiette plate coupe
relief glow gray
27312650020 Ø 15 cm   7.30
27312700020 Ø 20 cm   13.30
27312760020 Ø 26 cm   22.60
27312780020 Ø 28 cm   26.60
27312820020 Ø 32 cm   34.45

 **Teller tief coup**
Assiette creuse coupe
relief glow gray
27313740020 Ø 24 cm   21.05
27313790020 Ø 29 cm   31.45

 **Schale**
Bol
relief glow gray
27361620020 Ø 12 cm   12.75
27361660020 Ø 16 cm   18.35

 **Schale**
Bol
relief glow gray
27361690020 Ø 19 cm   22.60
27361730020 Ø 23 cm   31.45

 **Platte oval coup**
Plat ovale coupe
relief glow gray
27322730020 23 x 15 cm   26.60
27322820020 32 x 19 cm   41.95
27322870020 37 x 22 cm   49.30

 **Platte oval coup**
Plat ovale coupe
relief glow gray
27322960020 46 x 18 cm   69.95

scope glow sea





Espresso-Tasse
Tasse à espresso
glow sea
9 cl

27352590025   9.85



Espresso-Untertasse
Soutasse à espresso
glow sea
9 cl / Ø 12 cm

27369590025   6.35



Kaffee-Tasse
Tasse à café
glow sea
18 cl

27351680025   12.75



Tasse nieder
Tasse basse
glow sea

27351720025   13.30
27351780025   15.55
27351850025   16.75



Becher
Mug
glow sea
32 cl

27355320025   15.55





Kombi-Untertasse
Soutasse combi
relief glow sea

27369800025   8.35





Bowl
Bol
relief glow sea

27365450025   18.35













Untertasse zu Bowl 45 cl
Soutasse pour bol 45 cl
relief glow sea

27369950025   9.85



Teller flach coup
Assiette plate coupe
relief glow sea

27312650025   7.30
27312700025   13.30
27312760025   22.60
27312780025   26.60
27312820025   34.45



Teller tief coup
Assiette creuse coupe
relief glow sea

27313740025   21.05
27313790025   31.45



Schale
Bol
relief glow sea

27361620025   12.75
27361660025   18.35









Schale
Bol
relief glow sea

27361690025   22.60
27361730025   31.45





Platte oval coup
Plat ovale coupe
relief glow sea

27322730025   26.60
27322820025   41.95
27322870025   49.30



Platte oval coup
Plat ovale coupe
relief glow sea

27322960025   69.95



glatt
051



linea
015

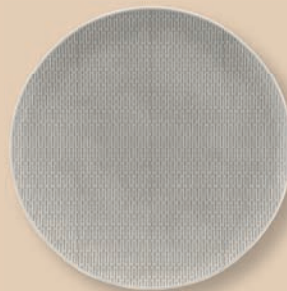

glow gray
020

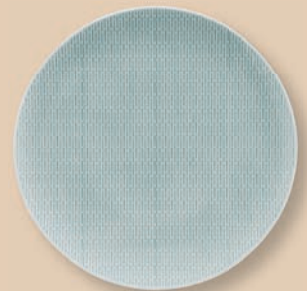

glow sea
025





BAUSCHER
GERMANY



country house

COUNTRY HOUSE vereint Qualitätsporzellan mit authentischer Handwerkskunst und bietet ein langlebiges Geschirr im Keramik-Look.



COUNTRY HOUSE associe une porcelaine de qualité à un artisanat authentique et il en résulte une vaisselle durable au look artisanal.









Teller flach
Assiette plate
 glow gray
 23 cm   19.95





Becher nieder
Gobelet bas
 glow gray
 28 cl / Ø 10 cm   13.30

Teller flach
Assiette plate
 glow gray
 26 cm   22.60





Becher hoch
Gobelet haut
 glow gray
 34 cl / Ø 10 cm   15.55





Teller flach
Assiette plate
 glow gray
 28 cm   28.25





Untertasse Doppelspiegel
Soutasse double marlis
 glow gray
 16 cm   10.60
passend: Schale 13 cm, Becher nieder, Becher hoch
 compatible: Bol 13 cm, gobelet bas, gobelet haut









Teller tief
Assiette creuse
 glow gray
 26 cm   25.30



Passende Artikel:
Articles compatibles:





Schale
Bol
 glow gray
 13 cm   16.75

Kaffee-Tasse
Tasse à café
 «Scope» glow gray
 18 cl   12.75

Schale
Bol
 glow gray
 16 cm   21.05

Tasse nieder
Tasse bas
 «Scope» glow gray
 22 cl   13.30
 27351780020 28 cl   15.55
 27351850020 35 cl   16.75

Schale
Bol
 glow gray
 20 cm   25.30

Becher
Mug
 «Scope» glow gray
 32 cl   15.55



country house



Teller flach
Assiette plate
glow sea
23 cm

27631223025

19.95



Becher nieder
Gobelet bas
glow sea
28 cl / Ø 10 cm

27636678025

13.30



Teller flach
Assiette plate
glow sea
26 cm

27631226025

22.60



Becher hoch
Gobelet haut
glow sea
34 cl / Ø 10 cm

27636684025

15.55



Teller flach
Assiette plate
glow sea
28 cm

27631228025

28.25



Untertasse Doppelspiegel
Soutasse double marlis
glow sea
16 cm

27637116025

10.60

passend: Schale 13 cm, Becher nieder, Becher hoch
compatible: Bol 13 cm, gobelet bas, gobelet haut



Teller tief
Assiette creuse
glow sea
26 cm

27631326025

25.30

Passende Artikel:
Articles compatibles:



Kaffee-Tasse
Tasse à café
«Scope» *glow sea*
18 cl

27351680025

12.75



Schale
Bol
glow sea
13 cm

27635713025

16.75



Tasse nieder
Tasse bas
«Scope» *glow sea*

27351720025

13.30

27351780025

15.55

27351850025

16.75



Schale
Bol
glow sea
16 cm

27635716025

21.05



Schale
Bol
glow sea
20 cm

27635720025

25.30



Becher
Mug
«Scope» *glow sea*
32 cl

27355320025

15.55



Teller flach
Assiette plate
glow sand
23 cm

27631223028

19.95



Becher nieder
Gobelet bas
glow sand
28 cl / Ø 10 cm

27636678028

13.30



Teller flach
Assiette plate
glow sand
26 cm

27631226028

22.60



Becher hoch
Gobelet haut
glow sand
34 cl / Ø 10 cm

27636684028

15.55



Teller flach
Assiette plate
glow sand
28 cm

27631228028

28.25



Untertasse Doppelspiegel
Soutasse double marlis
glow sand
16 cm

27637116028

10.60

passend: Schale 13 cm, Becher nieder, Becher hoch
compatible: Bol 13 cm, gobelet bas, gobelet haut



Teller tief
Assiette creuse
glow sand
26 cm

27631326028

25.30



Schale
Bol
glow sand
13 cm

27635713028

16.75



Schale
Bol
glow sand
16 cm

27635716028

21.05



Schale
Bol
glow sand
20 cm

27635720028

25.30



BAUSCHER
GERMANY

sandstone

Mit Sandstone zeigt Bauscher die Lebendigkeit natürlicher Steinstrukturen. In sechs Farbnuancen setzt das Dekorkonzept auf ein zurückhaltendes Ton-in-Ton von sanftem Beige bis zu intensivem Anthrazit.

Avec Sandstone, Bauscher montre la vitalité des structures de pierres naturelles. En six nuances de couleurs, le concept des décors se base sur un ton sur ton discret allant du beige doux à l'anthracite intense.



Espresso-Tasse hoch
Tasse à espresso haute

Uni Gray/Dark-Gray/Beige/Brown/Dark-Yellow/Orange

20195359xxx

9 cl

13.30



Cappuccino-Tasse
Tasse à cappuccino

Uni Gray/Dark-Gray/Beige/Brown/Dark-Yellow/Orange

20195175xxx

25 cl

16.75



Espresso-Tasse nieder
Tasse à espresso basse

Uni Gray/Dark-Gray/Beige/Brown/Dark-Yellow/Orange

20195159xxx

9 cl

12.75



Café au Lait-Tasse
Tasse café au lait

Uni Gray/Dark-Gray/Beige/Brown/Dark-Yellow/Orange

20195285xxx

35 cl

19.95



Espresso-Untertasse
Soutasse à espresso

Sandstone Gray/Black/Beige/Dark-Brown/Dark-Yellow/Orange

20196909xxx

9 cl / Ø 11 cm

7.05



Café au Lait-Tasse
Tasse café au lait

Uni Gray/Dark-Gray/Beige/Brown/Dark-Yellow/Orange

20195195xxx

45 cl

22.60



Tasse nieder
Tasse basse

Uni Gray/Dark-Gray/Beige/Brown/Dark-Yellow/Orange

20195168xxx

18 cl

15.55



Becher
Mug

Uni Gray/Dark-Gray/Beige/Brown/Dark-Yellow/Orange

20195632xxx

32 cl

18.35



Untertasse
Soutasse

Sandstone Gray/Black/Beige/Dark-Brown/Dark-Yellow/Orange

20196920xxx

18 cl / Ø 14 cm

8.35



Kombi-Untertasse
Soutasse combi

Sandstone Gray/Black/Beige/Dark-Brown/Dark-Yellow/Orange

20196945xxx

18-45 cl / Ø 16 cm

9.85

Preise inkl. Dekor
Prix incl. décor

Sehen Sie alle Artikel einzeln in den erhältlichen
Farben in unserem Onlineshop.
Voir tous les articles séparément dans les
couleurs disponibles dans notre boutique en ligne.



sandstone



Teller flach coup
Assiette plate coupe

Sandstone Gray/Black/Beige/Dark-Brown/Dark-Yellow/Orange

20191215xxx	Ø 15 cm			9.85
20191217xxx	Ø 17 cm			15.55
20191220xxx	Ø 20 cm			18.35
20191223xxx	Ø 23 cm			25.30
20191226xxx	Ø 26 cm			31.45
20191228xxx	Ø 28 cm			34.45
20191230xxx	Ø 30 cm			38.60
20191232xxx	Ø 32 cm			45.30



Teller tief coup
Assiette creuse coupe

Uni Gray/Dark-Gray/Beige/Brown/Dark-Yellow/Orange

20191318xxx	Ø 18 cm			16.75
-------------	---------	--	--	-------



Teller tief coup
Assiette creuse coupe

Sandstone Gray/Black/Beige/Dark-Brown/Dark-Yellow/Orange

20191324xxx	Ø 24 cm			26.60
20191330xxx	Ø 30 cm			38.60



Teller flach quadratisch
Assiette plate carrée

Sandstone Gray/Black/Beige/Dark-Brown/Dark-Yellow/Orange

20191519xxx	15,2 x 15,2 cm			13.30
20191529xxx	21,5 x 21,5 cm			22.60



Platte rechteckig
Plat rectangulaire

Sandstone Gray/Black/Beige/Dark-Brown/Dark-Yellow/Orange

20192330xxx	30,5 x 15,0 cm			45.30
-------------	----------------	--	--	-------



Platte rechteckig
Plat rectangulaire

Sandstone Gray/Black/Beige/Dark-Brown/Dark-Yellow/Orange

20192314xxx	13,9 x 9,4 cm			18.35
20192328xxx	27,8 x 18,2 cm			45.30
20192332xxx	32,0 x 23,1 cm			55.95
20192336xxx	36,1 x 23,1 cm			63.95



Platte oval coup
Plat ovale coupe

Sandstone Gray/Black/Beige/Dark-Brown/Dark-Yellow/Orange

20192232xxx	32,3 x 22,8 cm			51.95
20192237xxx	37,2 x 26,5 cm			63.95



Schale
Coupelle

Uni Gray/Dark-Gray/Beige/Brown/Dark-Yellow/Orange

20194060xxx	7 cl / Ø 8,2 cm			6.35
-------------	-----------------	--	--	------



Schale
Bol

Uni Gray/Dark-Gray/Beige/Brown/Dark-Yellow/Orange

20195712xxx	35 cl / Ø 12,2 cm			21.05
20195715xxx	65 cl / Ø 15,0 cm			31.45
20195717xxx	85 cl / Ø 17,2 cm			36.65
20195720xxx	124 cl / Ø 20,3 cm			49.30

Sehen Sie alle Artikel einzeln in den erhältlichen
Farben in unserem Onlineshop.
Voir tous les articles séparément dans les
couleurs disponibles dans notre boutique en ligne.



Preise inkl. Dekor
Prix incl. décor

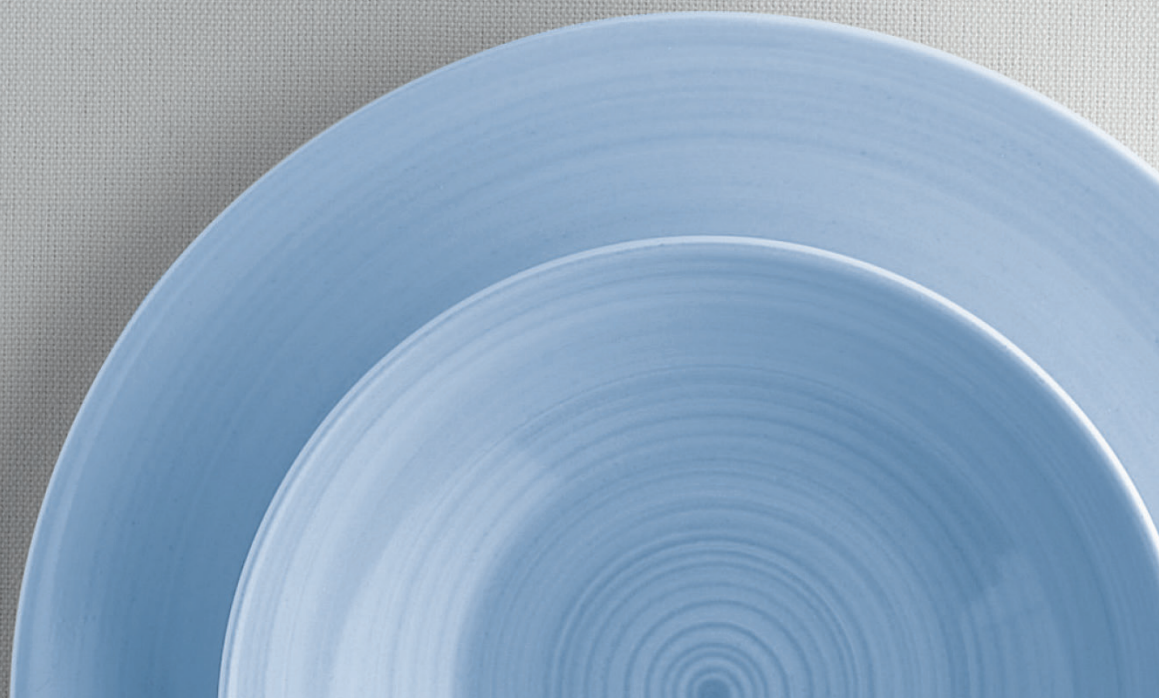

 **BAUSCHER**
GERMANY







modern rustic













Modern Rustic verschmilzt die Vorzüge von Bauscher Profi-Porzellan mit dem natürlichen Charme eines keramischen Looks.







La collection Modern Rustic associe les avantages de la porcelaine professionnelle Bauscher au charme naturel de la céramique.







				Style 1	Style 2+3
	Tasse Tasse				
25159xxxxxx	9 cl			13.30	15.85
25168xxxxxx	19 cl			15.85	18.60
25195xxxxxx	45 cl			24.75	29.55

				Style 1	Style 2+3
	Untertasse Soutasse				
26909xxxxxx	9 cl / Ø 12,0 cm			9.85	11.45
26918xxxxxx	18 cl / Ø 15,0 cm			11.45	13.30
26940xxxxxx	45 cl / Ø 19,1 cm			15.85	18.60

				Style 1	Style 2+3
	Teller flach coup rund Assiette plate coupe ronde				
21215xxxxxx	Ø 15,0 cm			11.45	13.30
21217xxxxxx	Ø 17,0 cm			17.30	20.35
21220xxxxxx	Ø 20,2 cm			20.35	23.85
21226xxxxxx	Ø 26,1 cm			32.75	38.60
21228xxxxxx	Ø 28,1 cm			38.60	43.95
21232xxxxxx	Ø 31,8 cm			49.30	59.95

				Style 1	Style 2+3
	Teller tief coup rund Assiette creuse coupe ronde				
21318xxxxxx	Ø 18,0 cm			19.95	22.60
21324xxxxxx	Ø 23,9 cm			31.45	34.45
21330xxxxxx	Ø 30,2 cm			46.60	53.15

				Style 1	Style 2+3
	Platte coup rechteckig Plat coup rectangulaire				
22328xxxxxx	27,9 x 18,3 cm			51.95	59.95
22332xxxxxx	32,0 x 23,1 cm			61.30	72.50

				Style 1	Style 2+3
	Schale Bol				
24060xxxxxx	7 cl			6.65	7.85

				Style 1	Style 2+3
	Schale Bol				
25712xxxxxx	35 cl			21.70	25.30
25715xxxxxx	65 cl			34.25	38.60

Preise inkl. Dekor
Dekore und Nummern auf der nächsten Seite

Prix incl. décor
Décors et numéros d'article vous trouvez dans la page suivante

Sehen Sie alle Artikel einzeln in den erhältlichen
Farben in unserem Onlineshop.
Voir tous les articles séparément dans les
couleurs disponibles dans notre boutique en ligne.



modern rustic



Dekore
Décors

Style 1



820302
Ceramica Blue



820301
Ceramica Sand



820300
Ceramica Wood



820299
Ceramica Gray



700410
Stone Gray

Style 2



700457
Natural Blue



700467
Natural Sand



700466
Natural Wood



700460
Natural Gray

Style 3



820357
Rustic River



820373
Rustic Sand



820368
Rustic Wood



820369
Rustic Lagoon



820355
Rustic Lobster

Sehen Sie alle Artikel einzeln in den erhältlichen
Farben in unserem Onlineshop.
Voir tous les articles séparément dans les
couleurs disponibles dans notre boutique en ligne.







 **BAUSCHER**
GERMANY

options

Design und Vielfalt: mit Options wird jeder Tisch zum individuellen Ereignis. Puristisch und modern ist die Serie ein Hingucker auf jedem Tisch.

Design et diversité: Options fait de chaque table un enchantement individuel. Puriste et moderne, cette série attire le regard sur n'importe quelle table.



block
buster



Kaffeekanne komplett
Cafetière complète

27100030051	30 cl		31.45
27100031051	30 cl		23.95
27100003051	30 cl		8.35



Teekanne komplett
Théière complète

27101035051	35 cl		34.25
27101036051	35 cl		25.30
27101053051	35 cl		9.85



Cremier
Crémier

27102005051	5 cl		9.85
-------------	------	--	------



Milchkanne
Pot à lait

27102015051	15 cl		15.55
-------------	-------	--	-------



Eierbecher
Coquetier

27124000051	Ø 5,2 cm x H 4 cm		7.05
-------------	-------------------	--	------



Espresso-Tasse
Tasse à espresso

27113009051	9 cl		8.35
-------------	------	--	------



Espresso-/Eierbecher-Untertasse rund
Soutasse à espresso/coquetier rond

27113090051	9 cl / Ø 12 cm		5.55
-------------	----------------	--	------



Espresso-/Eierbecher-Untertasse dreieckig
Soutasse à espresso/coquetier triangulaire

27115090051	9 cl / 10,4 cm		5.60
-------------	----------------	--	------



Kaffee-Tasse
Tasse à café

27113018051	18 cl		9.30
27113022051	22 cl		9.85



Kaffee-Tasse
Tasse à café

27113026051	26 cl		12.75
-------------	-------	--	-------



options



block
buster





Café au Lait-Tasse
Tasse café au lait

27113040051 44 cl   15.55



Kombi-Untertasse rund
Soutasse multiple ronde

27113081051 18/22/26/28 cl / Ø 15 cm   6.35



Tasse stapelbar
Tasse à café empilable

21953017051 19 cl   9.85



Kombi-Untertasse viereckig
Soutasse multiple carrée

27117081051 18/22/26/28 cl / 13,6 cm   7.05





Mug
Gobelet

27156126051 26 cl   8.75



Café au Lait-Untertasse
Soutasse café au lait

27113000051 44 cl / Ø 19,1 cm   8.35





Mug
Gobelet

27156028051 28 cl   12.75



Untertasse zu Stapeltassen
Soutasse pour tasses empilables

21969015051 19/27 cl / Ø 14,7 cm   6.15



Suppen-Tasse
Tasse à consommé

27156026051 26 cl   13.30



Bowl
Bol

27158026051 26 cl   9.85



Suppen-Tasse stapelbar
Tasse à consommé empilable

21928026051 27 cl   13.30



Teeschale
Bol

27155315051 15 cl   9.30



Teller flach coup rund
Assiette plate coupe ronde

27151015051	Ø 15,0 cm			12	6.35
27151217051	Ø 17,0 cm			12	9.30
27151020051	Ø 20,1 cm			12	11.15
27151026051	Ø 26,1 cm			6	18.35
27151028051	Ø 28,1 cm			6	22.60
27151230051	Ø 30,1 cm			6	25.30
27151032051	Ø 31,8 cm			6	31.45



Teller tief coup rund
Assiette creuse coupe ronde

27151081051	Ø 18,0 cm			12	9.85
27151024051	Ø 23,9 cm			6	16.75
27151030051	Ø 30,2 cm			6	23.95



Teller tief coup viereckig
Assiette creuse coupe carrée

27152003051	26,8 x 26,8 cm			6	23.95
-------------	----------------	--	--	---	-------



Teller flach coup viereckig
Assiette plate coupe carrée

27152015051	13,6 x 13,6 cm			12	7.05
27152021051	19,3 x 19,3 cm			12	12.75
27152027051	24,5 x 24,5 cm			6	19.95
27152032051	28,6 x 28,6 cm			6	25.30



Teller tief coup dreieckig
Assiette creuse coupe triangulaire

27153003051	26,5 x 26,5 cm			6	23.95
-------------	----------------	--	--	---	-------



Teller flach coup dreieckig
Assiette plate coupe triangulaire

27153011051	10,5 x 10,5 cm			12	5.55
27153020051	19,0 x 19,0 cm			12	12.75
27153025051	24,4 x 24,4 cm			6	18.35
27153032051	28,0 x 28,0 cm			6	25.30



Teller halbtief coup rund
Assiette demi-creuse coupe ronde

27154024051	Ø 24,0 cm			6	16.75
27154028051	Ø 28,2 cm			6	22.60
27154031051	Ø 30,7 cm			6	28.25





options



block
buster











Teller flach quadratisch
Assiette plate carrée

20090380051 31,9 x 31,9 cm   41.95











Bowl eckig
Bol carrée

20096660051 7 cl / 10,6 x 10,6 cm   12.75
20096665051 20 cl / 14,8 x 14,8 cm   18.35
20096669051 39 cl / 18,7 x 18,7 cm   23.95
20096673051 70 cl / 23,6 x 23,6 cm   31.45







Platte rechteckig
Plat rectangulaire

27162014051 13,9 x 9,4 cm   11.15
27162028051 27,8 x 18,2 cm   28.25
27162032051 32,0 x 23,1 cm   34.25
27162036051 36,1 x 23,1 cm   36.65







Schale oval
Saladier ovale

27177010051 8 cl / 10,8 x 6,1 cm   7.30
27187014051 27 cl / 14,3 x 8,5 cm   9.85



Schale rund
Saladier rond

27180014051 32 cl / Ø 14,1 cm   12.75
27180016051 51 cl / Ø 16,5 cm   16.75





**Leuchter
Bougeoir**

27198000051 Ø 6,9 cm x H 12 cm   19.95



**Ascher
Cendrier**

27191000051 Ø 9,2 x H 3,4 cm   7.05









**Porzellanlöffel
Cuillère en porcelaine**

27167900051 13 x 4,5 cm   12.75









**Etagere 2er rund*
Étagère ronde 2 étages***

20147802051 Stab versilbert** | Tige argenté**
H 24,8 cm   38.60
27107203051 Etagerteller rund | Assiette pour étagère
20 cm   15.55
27107202051 26 cm   25.30



**Etagere 2er viereckig*
Étagère carrée 2 étages***

20147802051 Stab versilbert** | Tige argenté**
H 24,8 cm   38.60
27167206051 Etagerteller eckig | Assiette pour étagère
19,3 x 19,3 cm   16.75
27167205051 24,5 x 24,5 cm   23.95

* Die Etageren werden in Einzelteilen mit Montageanleitung geliefert.
Les étagères sont livrées en pièces détachées avec une notice de montage.

** Alle Stäbe der Etageren sind nicht spülmaschinengeeignet und sollten nur mit einem feuchten Tuch gereinigt und trocken nachgewischt werden. Bitte daher die Etageren zum Spülen auseinanderbauen.
Les éléments en inox ne peuvent pas être lavés dans le lave-vaisselle. Pour le nettoyage, veuillez s.v.p., démonter le support central. Les éléments en inox doivent être nettoyés séparément avec un chiffon humide, puis séchés.



BAUSCHER
GERMANY

enjoy

Greifen Sie zu aussergewöhnlichen Formen - mit der Serie Enjoy gestalten Sie ein exquisites Gedeck. Inspiriert von einem feinen Kurvenlauf hat jeder Artikel seine individuelle Form.

Optez pour des formes extraordinaires. Avec la série Enjoy, concevez un ensemble raffiné. Inspiré par une belle courbe, chaque article possède néanmoins sa propre forme.



Kaffeekanne komplett
Cafetière complète

20104130051	30 cl		34.25
Kaffeekanne Unterteil Cafetière corps			
20104131051	30 cl		24.75
Kaffeekanne Deckel Cafetière couvercle			
20104132051	30 cl		11.15



Teekanne komplett
Théière complète

20104340051	40 cl		41.95
Teekanne Unterteil Théière corps			
20104341051	40 cl		29.55
Teekanne Deckel Théière couvercle			
20104342051	40 cl		12.75



Teesieb Kunststoff
Filtre plastique

418132300	Ø 7,5 cm x H 7,7 cm		22.60
-----------	---------------------	--	-------



Cremier
Crémier

20104605051	5 cl		12.25
-------------	------	--	-------



Milchkanne
Pot à lait

20104715051	15 cl		17.30
20104730051	30 cl		23.85



Zuckertütenbehälter
Sucrier spécial

20107911051	12,8 x 7,4 cm x H 4,4 cm		19.95
-------------	--------------------------	--	-------



Espresso-Tasse
Tasse à espresso

20105259051	9 cl		7.55
-------------	------	--	------



Espresso-Untertasse rund
Soutasse à espresso ronde

20106909051	Ø 13,4 cm		6.10
-------------	-----------	--	------



Espresso-Untertasse asymmetrisch
Soutasse à espresso asymétrique

20107109051	11,5 x 12 cm		6.10
-------------	--------------	--	------



Kaffee-Tasse
Tasse à café

20105168051	18 cl		10.90
-------------	-------	--	-------



Kaffee-Tasse
Tasse à café

20105175051	25 cl		13.30
20105185051	35 cl		15.55
20105194051	44 cl		17.30



Kaffee-Tasse hoch
Tasse à café haute

20105325051	25 cl		13.30
-------------	-------	--	-------



Kaffee-Tasse stapelbar
Tasse à café empilable

20105118051	18 cl		10.90
20105125051	25 cl		13.30



enjoy

block
buster

**Becher
Gobelet**

20105630051	30 cl			12.50
20105640051	40 cl			16.50
20105645051	45 cl			18.60



**Kombi-Untertasse asymmetrisch
Soutasse multiple asymétrique**

20107118051	18/25/30 cl / 15,0 x 14,1 cm			8.35
-------------	------------------------------	--	--	------



**Suppentasse
Tasse à consommé**

20102775051	25 cl			13.30
20102785051	35 cl			16.50
20102794051	44 cl			18.10



**Untertasse asymmetrisch mit 2 Spiegel
Soutasse asymétrique avec 2 marlis**

20107135051	35/44/45 cl / 17,4 x 14,9 cm			9.30
-------------	------------------------------	--	--	------



**Eintopfschale
Cocotte**

20106016051	80 cl			26.60
-------------	-------	--	--	-------



**Setplatte asymmetrisch mit 3 Spiegel
Plat asymétrique avec 3 marlis**

20102625051	18/25/30 cl / 26,1 x 17,5 cm			29.55
-------------	------------------------------	--	--	-------



**Bowl
Bol**

20106568051	18 cl			9.85
20106585051	35 cl			13.30
20106594051	44 cl			15.85



**Teller tief asymmetrisch
Assiette creuse asymétrique**

20101623051	23,1 x 21,4 cm			15.55
-------------	----------------	--	--	-------



**Kombi-Untertasse rund
Soutasse multiple ronde**

20106918051	18/25/30 cl / 16,2 cm			7.55
-------------	-----------------------	--	--	------



**Teller flach rund Fahne
Assiette plate rond bord**

20100016051	Ø 16,1 cm			7.55
20100023051	Ø 22,7 cm			16.50
20100026051	Ø 26,2 cm			21.05
20100028051	Ø 27,9 cm			24.75
20100032051	Ø 31,9 cm			31.95



**Untertasse rund
Soutasse ronde**

20106935051	35/44/45 cl / 18,1 cm			9.30
-------------	-----------------------	--	--	------



Teller flach rund schmale Fahne
Assiette plate rond avec aile étroite

20100616051	Ø 16,2 cm			7.55
20100621051	Ø 21,0 cm			13.30
20100625051	Ø 25,7 cm			18.60
20100628051	Ø 28,0 cm			24.75
20100632051	Ø 32,0 cm			31.95



Teller tief rund Fahne
Assiette creuse rond bord

20100116051	Ø 16,1 cm			7.85
20100124051	Ø 24,1 cm			18.60
20100128051	Ø 28,1 cm			25.30

dekore/décors

Preise auf Anfrage
Prixes sur demande



Effect Augergine/Mint

Effect Augergine

Effect Stone

Doublée

Loom



Block Color
Powder Blue

Block Color
Jade

Block Color
Ocean

Block Color
Olive

Block Color
Melon

Block Color
Aubergine



BAUSCHER
GERMANY

avantgarde

Kreative Vielfalt ist das Erfolgsrezept von Avantgarde. Teller und Schalen in Tropfenform bereichern das Basis-Sortiment an klassischen runden Tellern mit breiter Fahne.

La variété créative est la recette du succès d'Avantgarde. Les assiettes et les bols en forme de gouttes enrichissent la gamme de base des assiettes rondes classiques à larges drapeaux.







Suppenschale
Bol à soupe

21436685051 35 cl / Ø 16,2 cm   15.85
passend: Teller flach 17 cm
compatible: assiette plate 17 cm













Platte Tropfen
Plat goutteau

21432620051 20 x 10,5 cm   15.05
21432628051 28,3 x 16,7 cm   34.90







Teller flach
Assiette plate

21430017051 Ø 17 cm   11.45
21430023051 Ø 23 cm   18.35
21430027051 Ø 27 cm   25.30
21430029051 Ø 29 cm   28.75
21430032051 Ø 32 cm   34.90





Schale Tropfen
Saladier goutteau

21433817051 22 cl / 17,3 x 9,7 cm   15.05
21433323051 32 cl / 23,2 x 13,1 cm   31.95



Sauciere
Sauciere

21436112051 7cl / 12 x 11,2 cm   9.85



Teller tief
Assiete creuse

21430120051 Ø 20 cm   15.05
21430124051 Ø 24 cm   20.65
21430128051 Ø 28 cm   28.25
21430132051 Ø 32 cm   37.95

dekore/décors

Preise auf Anfrage
Prixes sur demande



alfeo



lenox



loop pearl blue



 **BAUSCHER**
GERMANY

relation today

Die schlichten und äusserst robusten Artikel sind die idealen Basics und passen zu unterschiedlichen gastronomischen Stilen.

Ces articles sobres et extrêmement robustes sont les basiques idéaux et s'adaptent à différents styles gastronomiques.



Espresso-Tasse
Tasse à espresso

24652590051 9 cl 9.30



Espresso-Tasse stapelbar
Tasse à espresso empilable

24652090051 9 cl 9.30



Espresso-Untertasse
Soutasse à espresso

24669090051 9 cl / Ø 12 cm 7.55



Kaffee-Tasse
Tasse à café

24652680051 18 cl 11.45



Kaffee-Tasse
Tasse à café

24652740051 24 cl 12.75



Kaffee-Tasse stapelbar
Tasse à café empilable

24651180051 18 cl 11.45
24651250051 25 cl 13.05



Tee-Tasse
Tasse à thé

24651720051 22 cl 12.35



Becher
Gobelet

24656780051 28 cl 13.30



Becher stapelbar
Gobelet empilable

24655280051 28 cl 13.30



Suppen-Tasse stapelbar
Tasse à consommé empilable

24627260051 28 cl 15.05



Kombi-Untertasse
Soutasse à consommé

24669180051 18-28 cl / Ø 16 cm 7.95



Suppen-Tasse stapelbar
Tasse à consommé empilable

24627400051 40 cl 17.70



Teller flach
Assiette plate

24600160051 Ø 16 cm 7.95
24600200051 Ø 20 cm 12.65
24600230051 Ø 23 cm 17.30
24600230051 Ø 25 cm 19.80
24600250051 Ø 27 cm 22.60
24600270051 Ø 28 cm 24.65
24600310051 Ø 31 cm 29.95



Teller tief
Assiette creuse

24601240051 Ø 24 cm 19.80
24601280051 Ø 28 cm 25.30



Platte oval
Plat ovale

24620290051 29,7 x 21,2 cm 33.30
24620330051 33,5 x 23,8 cm 39.75



Schälchen
Coupelle

24657580051 6 cl / Ø 8 cm 5.30



Schale
Bol

24630630051 31 cl / Ø 12,9 cm 13.30
24631650051 50 cl / Ø 15,2 cm 18.60
24631680051 85 cl / Ø 17,7 cm 26.40
24631710051 135 cl / Ø 21,0 cm 31.95



BAUSCHER
GERMANY

maitre

Das erstklassige Design zeigt sich in runden Tellern mit breiter Fahne, Platten mit asymmetrisch gestalteter Fahne, variierenden Tassenformen und einem ergänzenden Struktursortiment.

Le design de première classe se révèle par des assiettes rondes avec un bord large, des assiettes avec bord asymétrique, des formes de tasses variées et une gamme complémentaire avec relief.

Kaffeekanne komplett
Cafetière complète

27000030051	30 cl		34.25
Kaffeekanne Unterteil Cafetière corps			
27000031051	30 cl		23.95
Kaffeekanne Deckel Cafetière couvercle			
27000003051	30 cl		8.35

Zuckerdose komplett
Sucrier complet

27049025051	25 cl		22.10
Zuckerdose Unterteil Sucrier corps			
27049026051	25 cl		13.30
Zuckerdose Deckel Sucrier couvercle			
27049027051	25 cl		7.85

Teekanne komplett
Théière complète

27043038051	35 cl		37.95
Teekanne Unterteil Théière corps			
27043039051	35 cl		23.95
Teekanne Deckel Théière couvercle			
27043040051	35 cl		9.30

Zuckerbowl
Bol à sucre

27008026051	27 cl / Ø 9,9 cm		12.75
-------------	------------------	--	-------

Espresso-Tasse stapelbar
Tasse à espresso empilable

27010009051	9 cl		9.30
-------------	------	--	------

Teesieb Kunststoff
Filtre plastique

418132300	7,5 cm x H 7,7 cm		22.60
-----------	-------------------	--	-------

Espresso-Untertasse
Soutasse à espresso

27010090051	9 cl / Ø 12,6 cm		6.10
-------------	------------------	--	------

Teesiebablage
Support pour filtre

27065018051	Ø 7,2 cm x H 7,2 cm		9.85
-------------	---------------------	--	------

Kaffee-Tasse stapelbar
Tasse à café empilable

27010018051	19 cl		10.90
27052022051	22 cl		11.95

Cremier
Crémier

21102004051	4 cl		8.65
-------------	------	--	------

Cappuccino-Tasse
Tasse à cappuccino

27052075051	25 cl		12.75
-------------	-------	--	-------

Milchkanne mit Henkel
Pot à lait avec anse

27002015051	15 cl		16.75
27047030051	30 cl		24.75

Suppen-Tasse stapelbar
Tasse à consommé empilable

27057026051	27 cl		13.30
-------------	-------	--	-------

Eierbecher
Coquetier



29302000051	Ø 5 cm x H 4 cm		6.65
-------------	-----------------	--	------



maître



Kombi-Untertasse
Soutasse multiple

27010081051 19-27 cl / Ø 16,0 cm   7.05



Trinkbecher mit Henkel
Mug avec anse

27019028051 30 cl   13.30





Café au Lait-Tasse
Tasse à café au lait

27052085051 35 cl    15.05

















Untertasse
Soutasse

27069035051 30/35 cl / Ø 17,4 cm    8.35













Teller flach breite Fahne
Assiette plate bord large

27006016051 Ø 16,1 cm   7.70
27006021051 Ø 21,1 cm   13.30
27006024051 Ø 24,1 cm    16.75
27006026051 Ø 26,2 cm   19.95
27006028051 Ø 28,2 cm   23.85
27006032051 Ø 31,9 cm    31.45



Teller flach
Assiette plate

21030017051 Ø 17,2 cm   9.85
21030020051 Ø 20,0 cm   11.95
21030025051 Ø 24,6 cm    18.35
21030028051 Ø 27,7 cm   23.85
21030032051 Ø 31,0 cm   31.45



Teller tief breite Fahne
Assiette creuse bord large

27007020051 Ø 20,0 cm    12.75
27007025051 Ø 25,2 cm   19.95
27007028051 Ø 28,4 cm   25.30



Exquisitteller flach mit Fahne
Assiette plate exquisite avec aile

20070634051 Ø 34,0 cm    37.95



Exquisitteller flach «Glimmer quadratisch»
Assiette plate exquisite «Glimmer carré»

20070634778 Ø 34,0 cm    63.95



Exquisitteller flach «Glimmer Floral»
Assiette plate exquisite «Glimmer floral»

20070634779 Ø 34,0 cm    63.95



Exquisitteller tief mit Fahne
Assiette creuse exquisite avec aile

20070724051 Ø 24,2 cm    19.95
20070728051 Ø 28,2 cm    28.25



Gourmetteller tief
Assiette creuse bord large

27001928051 Ø 27,7 cm   25.30



Teller tief
Assiette creuse

21030023051 Ø 23,3 cm   16.75













Teller halbtief
Assiette demi-creuse

21030002051 Ø 20,0 cm   12.75



Strukturteller flach breite Fahne
Assiette structurelle plate bord large

27001866051 Ø 16,0 cm   7.70
 27001871051 Ø 21,0 cm   13.30
 27001876051 Ø 26,3 cm   19.95
 27001878051 Ø 28,2 cm   23.85
 27001882051 Ø 31,8 cm   31.45





Strukturteller tief breite Fahne
Assiette structurelle creuse

27001975051 Ø 25,0 cm   19.95
 27001978051 Ø 28,3 cm   25.30







Platte oval
Plat ovale

27020030051 30,2 x 13,4 cm   34.25











Platte oval
Plat ovale

27020033051 33,0 x 19,8 cm   38.60
 27020038051 38,4 x 21,6 cm   47.95



Schale
Bol

29411012051 35 cl / Ø 12,2 cm   13.30
 29412015051 65 cl / Ø 15,0 cm   19.95
 29412017051 85 cl / Ø 17,2 cm   23.95
 29412020051 124 cl / Ø 20,3 cm   34.25



Blütenschale
Coupelle «fleur»

20076209051 13,0 x 9,5 cm   11.15



 **BAUSCHER**
GERMANY

bonn/bistro

So funktionell und innovativ muss Geschirr heute sein. Die Serie strahlt Lebensfreude und eine positive Ausstrahlung aus. Weiche Formen welche sich überall anpassen und eine gute Gattung machen.

Fonctionnelle et innovatrice – comme toute la vaisselle devrait être aujourd’hui. La série respire la joie de vivre et un charme positif. Ses formes douces s’adaptent partout et font un bon genre.



Kaffeekanne komplett
Cafetière complète

25400030051	30 cl		31.45
	Kaffeekanne Unterteil Cafetière corps		
25404131051	30 cl		22.60
	Kaffeekanne Deckel Cafetière couvercle		
25400003051	30 cl		8.25



Teekanne komplett
Théière complète

25401040051	35 cl		37.95
	Teekanne Unterteil Théière corps		
25404341051	35 cl		28.25



Cremier / Milchkanne
Crémier / Pot à lait

25402005051	5 cl		10.90
25402010051	9 cl		13.30
25402015051	14 cl		16.50
25402030051	30 cl		22.60
25402080051	1,7 L		78.60



Schale
Coupelle

25564008051	7 cl / Ø 8,2 cm		4.65
-------------	-----------------	--	------



Butterschale oval
Coupelle à beurre, ovale

25565011051	8 cl / 11 x 8 cm		9.30
-------------	------------------	--	------



Zuckerdose komplett
Sucrier complet

25403025051	24 cl		19.95
	Zuckerdose Unterteil Sucrier corps		
25406026051	24 cl		11.95
	Zuckerdose Deckel Sucrier couvercle		
25406075051	24 cl		7.85



Espresso-Tasse hoch
Tasse à espresso haute
«Bistro»

20224000051	9 cl		9.55
-------------	------	--	------



Espresso-Tasse nieder
Tasse à espresso basse
«Bistro»

23571009051	9 cl		8.35
-------------	------	--	------



Espresso-Untertasse
Soutasse à espresso
«Bistro»

23571090051	9 cl / Ø 11,3 cm		5.30
-------------	------------------	--	------



bonn/bistro



Tasse nieder
Tasse basse
«Bistro»

23571018051 19 cl   9.85





Café au Lait-Tasse
Tasse café au lait
«Bistro»

23647045051 45 cl   15.85



Untertasse
Soutasse
«Bistro»

23571002051 19 cl / Ø 14,1 cm   6.25



Suppen-Tasse
Tasse à consommé
«Bistro»

23751030051 32 cl   13.30





Cappuccino-Tasse
Tasse à cappuccino
«Bistro»

23571025051 25 cl   11.45



Untertasse
Soutasse
«Bistro»

23751000051 32+45 cl / Ø 15,7 cm   7.05



Café au Lait-Tasse
Tasse café au lait
«Bistro»

23647035051 35 cl   13.30



Mezza Bowl
Bol Mezza
«Bonn»

21958017051 38 cl   15.05



Tasse Glockenform
Tasse évasée
«Bistro»

27601025051 26 cl   13.30





Becher
Mug

23571053051 32 cl   13.30



Untertasse
Soutasse
«Bistro»

23571052051 25/35 cl / Ø 15,1 cm   6.65



Kombi-Untertasse
Soutasse combi

23571054051 Ø 16 cm   7.05



Teller flach Fahne
Assiette plate avec aile

25382016051	Ø 16,0 cm			12	6.65
25382019051	Ø 18,9 cm			12	10.90
25382020051	Ø 20,2 cm			12	11.95
25382023051	Ø 23,1 cm			6	15.05
25382024051	Ø 24,1 cm			6	16.75
25382025051	Ø 25,8 cm			6	17.30
25382027051	Ø 27,2 cm			6	21.05
25382030051	Ø 30,2 cm			6	25.30



Sauciere
Saucière

25561005051	5 cl			12	11.45
25561010051	10 cl			12	13.30
25561020051	20 cl			12	18.60
25561035051	35 cl			2	26.60



Teller halbtief Fahne
Assiette demi-creuse avec aile

25382091051	Ø 19,1 cm			12	11.45
-------------	-----------	--	--	----	-------



Teller tief Fahne
Assiette creuse avec aile

25382032051	23 cm			6	16.50
-------------	-------	--	--	---	-------



Tischvase
Vase à fleurs

25372000051	Ø 7,8 cm x 12,6 cm			6	15.85
-------------	--------------------	--	--	---	-------



Platte oval coup
Plat ovale coupe

25392023051	23,2 x 15,8 cm			6	22.10
25392026051	26,2 x 18,1 cm			6	26.60
25392029051	29,1 x 20,4 cm			6	31.95
25392032051	32,3 x 22,8 cm			6	34.45
25392037051	37,2 x 26,5 cm			6	43.95

dekore/décors

Preise auf Anfrage
Prixes sur demande



pinselband blau



 **BAUSCHER**
GERMANY

marie christine

Marie Christine erinnert an den Glanz früherer Epochen, üppig dekorierte Tafeln und die wohlige Wärme traditioneller Speisen, die verführerisch duften.

Marie Christine évoque la splendeur des époques passées, les tables somptueusement décorées et la chaleur réconfortante des plats traditionnels aux parfums alléchants.



Espresso-Tasse
Tasse à espresso

24552590051 9 cl   10.60



Espresso-Untertasse
Soutasse à espresso

24569090051 9 cl / 11 cm   6.60



Kaffee-Tasse
Tasse à café

24552690051 19 cl   12.65
24552720051 22 cl   13.30



Kombi-Untertasse
Soutasse multiple

24569190051 19-22 cl / Ø 14 cm   7.95



Tasse
Tasse

24552850051 34 cl   16.50



Untertasse zu Tasse
Soutasse pour tasse

24569350051 34 cl / Ø 15 cm   7.95



Tasse stapelbar
Tasse empilable

24552180051 18 cl   12.65



Suppen-Tasse stapelbar
Tasse à consommé empilable

24528280051 27 cl   15.95















Untertasse zu Stapeltassen
Soutasse pour tasses empilable

24569180051 18+27 cl / Ø 15 cm   7.95



Teller flach Fahne
Assiette plate avec aile

24500170051 Ø 17 cm   11.95
24500190051 Ø 19 cm   13.30
24500210051 Ø 21 cm   15.95
24500250051 Ø 25 cm   21.30
24500280051 Ø 28 cm   26.60
24500300051 Ø 31 cm   31.95



Teller flach coup
Assiette plate coupe

24512160051 Ø 16 cm   7.95
24512200051 Ø 20 cm   13.30
24512270051 Ø 27 cm   25.30









Teller tief Fahne
Assiette creuse avec aile

24501230051 Ø 23 cm   19.80
24501280051 Ø 28 cm   26.40



Platte oval Fahne
Plat ovale avec aile

24520250051 25 x 17 cm   29.80
24520300051 30 x 19 cm   39.75
24520350051 35 x 23 cm   47.95





Schälchen
Bol

24557600051 Ø 10 cm   6.60







Schale
Bol

24530630051 20 cl / Ø 13 cm   15.95



Saladier
Saladier

24531670051 48 cl / Ø 17 cm   18.60
24531710051 90 cl / Ø 21 cm   29.30



Cremier
Crémier

24547150051 15 cl   19.45



Sauciere
Saucière

24538150051 12 cl   18.60



 **BAUSCHER**
GERMANY

dimension

Das stilvolle Geschirrprogramm für den Anspruch einer neuen Generation. Funktionalität und ansprechendes Design in Einem.

L'élégante gamme de vaisselle répondant aux exigences d'une nouvelle génération. Fonctionnalité et design attrayant en un.



Kaffeekanne komplett
Cafetière complète

29041031051	30 cl		34.25
Kaffeekanne Unterteil Cafetière corps			
29041030051	30 cl		24.75
Kaffeekanne Deckel Cafetière couvercle			
29041032051	30 cl		8.65



Teekanne komplett
Théière complète

29043036051	35 cl		34.90
Teekanne Unterteil Théière corps			
29043038051	35 cl		26.60
Teekanne Deckel Théière couvercle			
29043037051	35 cl		8.65



Cremier / Milchkanne
Crémier / Pot à lait

29046015051	15 cl		13.30
-------------	-------	--	-------



Zuckerdose komplett
Sucrier complet

29005022051	22 cl		19.95
Zuckerdose Unterteil Sucrier corps			
29005024051	22 cl		13.30
Zuckerdose Deckel Sucrier couvercle			
29005023051	22 cl		8.65



Espresso-Tasse
Tasse à espresso

29052009051	9 cl		9.30
-------------	------	--	------



Espresso-Untertasse
Soutasse à espresso

29069090051	9 cl / Ø 12,3 cm		5.85
-------------	------------------	--	------



Kaffee-Tasse
Tasse à café

29013018051	18 cl		11.45
-------------	-------	--	-------



Kaffee-Tasse
Tasse à café

29053075051	25 cl		11.95
-------------	-------	--	-------



Kaffee-Tasse stapelbar
Tasse à café empilable

29051018051	18 cl		11.45
29051022051	22 cl		11.95



Becher stapelbar
Gobelet empilable

29056029051	29 cl		13.30
-------------	-------	--	-------



Suppen-Tasse stapelbar
Tasse à consommé empilable

29027027051	28 cl		13.30
-------------	-------	--	-------



Kombi-Untertasse
Soutasse multiple

29069081051	18-29 cl / Ø 15,5 cm		7.15
-------------	----------------------	--	------



dimension



Teller flach Fahne
Assiette plate bord

29000016051	Ø 16,0 cm			12	7.15
29000020051	Ø 20,0 cm			12	11.95
29000023051	Ø 22,9 cm			6	16.75
29000025051	Ø 25,5 cm			6	18.35
29000028051	Ø 27,6 cm			6	22.60
29000031051	Ø 31,3 cm			6	29.30



Teller flach schmale Fahne
Assiette plate avec aile étroite

29000624051	Ø 24,0 cm			6	16.75
29000625051	Ø 25,7 cm			6	18.35



Teller halbtief
Assiette demi-creuse

29000220051	Ø 20,0 cm			12	13.30
-------------	-----------	--	--	----	-------



Teller tief
Assiette creuse

29001023051	Ø 23,2 cm			6	17.30
-------------	-----------	--	--	---	-------



Platte oval
Plat ovale

29020029051	28,9 x 18,7 cm			6	34.25
29020032051	31,9 x 20,7 cm			6	38.60
29002036051	35,6 x 23,7 cm			6	43.95



Saladier rund
Saladier rond

29080015051	22 cl / Ø 15,0 cm			6	10.60
29080018051	45 cl / Ø 18,1 cm			6	15.85



Suppenschale
Bol à soupe

29029040051	44 cl / Ø 14,7 cm			6	13.30
-------------	-------------------	--	--	---	-------



Eintopfschale
Cocotte

29060090051	85 cl / Ø 20,2 cm			6	26.60
-------------	-------------------	--	--	---	-------



Bowl rund
Bol rond

29065027051	28 cl / Ø 10 cm x H 5,5 cm			12	11.95
-------------	----------------------------	--	--	----	-------



Kompottschale
Compotier rond

29030062051	27 cl / Ø 12 cm			12	11.95
-------------	-----------------	--	--	----	-------



Sauciere
Saucière

29077010051	10 cl			12	13.30
-------------	-------	--	--	----	-------



dekore/décors

Preise auf Anfrage
Prixes sur demande



salina



velino



kenora



bandera



amano blau



amano grau



Slon



 **BAUSCHER**
GERMANY

dialog

Ein zeitloses Design, welches für stilvolle Stimmung sorgt auf jedem gedeckten Tisch. Das feine Relief verleiht der Serie Dialog eine schlichte Eleganz.

Un design intemporel qui crée une atmosphère élégante sur n'importe quelle table. Le relief fin confère à la série Dialog une élégance simple.



Kaffeekanne komplett
Cafetière complète

28000030051	30 cl		34.25
Kaffeekanne Unterteil Cafetière corps			
28000031051	30 cl		25.30
Kaffeekanne Deckel Cafetière couvercle			
28000003051	30 cl		9.05



Zuckerdose mit Deckelausschnitt komplett
Sucrier avec couvercle à encoche complète

28006018051	18 cl		21.05
Zuckerdose Unterteil Sucrier corps			
28006019051	18 cl		13.30
Zuckerdose Deckel Sucrier couvercle			
28006020051	18 cl		9.30



Teekanne komplett
Théière complète

28001035051	35 cl		36.65
Teekanne Unterteil Théière corps			
28001036051	35 cl		28.25
Teekanne Deckel Théière couvercle			
28001053051	35 cl		9.30



Espresso-Tasse stapelbar
Tasse à espresso empilable

28015009051	9 cl		9.30
-------------	------	--	------



Espresso-Untertasse
Soutasse à espresso

28010090051	9 cl / Ø 13 cm		6.35
-------------	----------------	--	------



Cremier
Crémier

28002004051	4 cl		9.85
-------------	------	--	------



Kaffee-Tasse stapelbar
Tasse à café empilable

28010018051	18 cl		10.90
28010022051	22 cl		11.95
28010027051	27 cl		13.30



Milchkanne mit Henkel
Pot à lait avec anse

28002015051	15 cl		18.35
28002030051	32 cl		25.30



Trinkbecher mit Henkel
Gobelet avec anse

28019026051	26 cl		13.30
-------------	-------	--	-------



Butterschale
Beurrier

28022006051	Ø 6,6 cm x H 2,8 cm		4.65
-------------	---------------------	--	------



Suppen-Tasse stapelbar
Tasse à consommé empilable

28055027051	28 cl		15.05
-------------	-------	--	-------



Kombi-Untertasse
Soutasse multiple

28010081051	18-28 cl / Ø 16,0 cm		7.55
-------------	----------------------	--	------



dialog

**Teller flach Fahne**
Assiette plate avec aile

28050016051	Ø 16,0 cm			7.55
28050020051	Ø 20,1 cm			11.95
28050023051	Ø 23,4 cm			16.50
28050025051	Ø 25,7 cm			18.35
28050028051	Ø 27,6 cm			23.85
28050031051	Ø 31,0 cm			29.55

**Teller flach schmale Fahne**
Assiette plate avec aile étroite

28049025051	Ø 25,7 cm			18.35
-------------	-----------	--	--	-------

**Teller halbtief Fahne**
Assiette demi-creuse avec aile

28050002051	Ø 20,0 cm			13.30
-------------	-----------	--	--	-------

**Teller tief Fahne**
Assiette creuse avec aile

28050032051	Ø 23,4 cm			18.10
-------------	-----------	--	--	-------

**Platte oval**
Plat ovale

28061026051	26,0 x 17,9 cm			26.60
28061032051	32,0 x 24,0 cm			38.60

**Saladier rund**
Saladier rond

28080016051	32 cl / Ø 15,8 cm			13.30
28080018051	48 cl / Ø 18,7 cm			18.35
28080022051	78 cl / Ø 22,2 cm			23.85

**Kompottschale rund**
Compotier rond

28085014051	22 cl / Ø 14,4 cm			10.60
-------------	-------------------	--	--	-------

**Kompottschale rund stapelbar**
Compotier rond empilable

28089012051	28 cl / Ø 12,2 cm			12.75
-------------	-------------------	--	--	-------

**Suppenschale stapelbar**
Bol à soupe empilable

28058012051	38 cl / Ø 12,0 cm			15.05
-------------	-------------------	--	--	-------

**Eintopfschale stapelbar**
Cocotte empilable

28058017051	94 cl / Ø 16,8 cm			26.60
-------------	-------------------	--	--	-------

**Bowl rund**
Bol rond

28058027051	28 cl / Ø 9,9 cm			12.75
-------------	------------------	--	--	-------

**Sauciere**
Saucière

28077010051	10 cl			15.05
28075030051	30 cl			26.60

dekore/décors

Preise auf Anfrage
Prixes sur demande



tina



cabo



grafische linien rot



poppy blau-rot



sonja



nadine



 **BAUSCHER**
GERMANY

carat

Gastlichkeit und Harmonie aus Porzellan für jeden Anlass. Ausgezeichnet durch ein feines Relief und Klarheit ist Carat ein wahrer Klassiker.

L'hospitalité et l'harmonie réunies en une porcelaine pour toutes les occasions. Caractérisé par un relief fin et une grande clarté, Carat est un véritable classique.



Kaffeekanne komplett
Cafetière complète

22500030051	30 cl			28.25
	Kaffeekanne Unterteil Cafetière corps			
22500031051	30 cl			21.05
	Kaffeekanne Deckel Cafetière couvercle			
22500003051	30 cl			7.30



Teekanne komplett
Théière complète

22501035051	35 cl			34.25
	Teekanne Unterteil Théière corps			
22501036051	35 cl			25.30
	Teekanne Deckel Théière couvercle			
22501053051	35 cl			8.25



Cremier / Milchkanne mit Henkel
Crémier / Pot à lait

22502005051	5 cl			9.85
22502015051	15 cl			13.30
22502030051	30 cl			21.05



Zuckerschale
Coupelle à sucre

22520008051	Ø 7,8 cm			4.25
-------------	----------	--	--	------



Espresso-Tasse stapelbar
Tasse à espresso empilable

22510009051	9 cl			7.30
-------------	------	--	--	------



Espresso-Untertasse
Soutasse à espresso

22510090051	9 cl / Ø 12,5 cm			5.55
-------------	------------------	--	--	------



Kaffee-Tasse stapelbar
Tasse à café empilable

22510018051	18 cl			9.30
22510022051	22 cl			9.85
22510028051	28 cl			11.95



Suppen-Tasse stapelbar
Tasse à consommé empilable

22555027051	27 cl			12.75
-------------	-------	--	--	-------



















Kombi-Untertasse
Soutasse multiple

22510081051	18-28 cl / Ø 15,9 cm			6.10
-------------	----------------------	--	--	------







carat





**Becher mit Henkel**
Gobelet avec anse22525028051 30 cl   11.15**Untertasse mit 2 Spiegel**
Soutasse avec 2 marlis22517000051 18-29 cl / Ø 15,9 cm   6.10*passend: Tasse stapelbar 18+22 cl / Becher 30 cl / Suppen-Tasse 27 cl**compatible: Tasse empilable 18+22 cl / Gobelet 30 cl / Tasse à consommé 27 cl***Suppen-Tasse stapelbar**
Tasse à consommé empilable22555030051 29 cl   12.75*passend: Teller flach Fahne 16 cm**compatible: Assiette plate avec aile 16 cm***Teller flach Fahne**
Assiette plate avec aile







22550016051	Ø 16,0 cm			6.15
22550020051	Ø 20,1 cm			9.85
22550023051	Ø 23,1 cm			13.30
22550024051	Ø 24,2 cm			15.55
22550025051	Ø 25,7 cm			15.95
22550027051	Ø 27,1 cm			18.35
22550028051	Ø 28,0 cm			19.95
22550030051	Ø 30,0 cm			22.60

**Teller flach schmale Fahne**
Assiette plate avec aile étroite22549025051 Ø 25,7 cm   15.55**Teller halbtief Fahne**
Assiette demi-creuse avec aile22550002051 Ø 20,0 cm   9.85**Teller tief Fahne**
Assiette creuse avec aile22550032051 Ø 23,1 cm   15.55**Platte oval flach**
Plat ovale plate

22561032051	32,4 x 24,0 cm			31.45
22561035051	36,0 x 26,7 cm			34.45

**Saladier rund**
Saladier rond

22580014051	35 cl / Ø 14,4 cm			15.55
22580017051	98 cl / Ø 17,2 cm			22.60

**Kompottschale rund**
Compotier rond22585012051 33 cl / Ø 12,3 cm   11.15**Eintopfschale**
Cocotte22584018051 90 cl / Ø 17,5 cm   22.60**Bowl rund**
Bol rond22558027051 27 cl / Ø 9,5 cm   10.90**Suppenschale**
Bol à soupe22558012051 38 cl / Ø 11,9 cm   12.75

dekore/décors

*Preise auf Anfrage
Prixes sur demande*



baccara



revue



laguna



BAUSCHER
GERMANY

smart white

Vielfalt und moderne Optik mit wenigen Artikeln. Mit den neuen, intelligent zusammengestellten Sortimenten von Bauscher Smart lassen sich Speisen und Getränke zeitgemäss servieren.

Avec les nouveaux assortiments Smart de Bauscher, intelligemment composés, la nourriture et les boissons peuvent être servies de manière contemporaine.



Espresso-Tasse
Tasse à espresso

27552580051 8 cl   3.15



Espresso-Untertasse
Soutasse à espresso

27569080051 Ø 12 cm   2.65



Kaffeeobertasse
Tasse à café

27552680051 18 cl   4.75
27552750051 25 cl   4.65
27552850051 35 cl   5.55



Mug
Mug

27556790051 28 cl   5.30





Kombi-Untertasse
Soutasse combi

27569180051 Ø 15 cm   2.50









Schale
Coupelle

27540600051 Ø 8 cm   1.95
27557120051 Ø 12 cm   4.75
27557150051 Ø 15 cm   7.15
27557200051 Ø 20 cm   11.95





Teller flach Fahne
Assiette plate bord

27500170051 Ø 17 cm   3.55
27500210051 Ø 21 cm   4.75
27500270051 Ø 27 cm   8.35
27500300051 Ø 30 cm   9.85



Teller tief Fahne
Assiette creuse bord

27501230051 Ø 23 cm   5.85
27501270051 Ø 27 cm   8.35





 **BAUSCHER**
GERMANY

smart dekor

Vielfalt und moderne Optik mit wenigen Artikeln. Mit den neuen, intelligent zusammengestellten Sortimenten von Bauscher Smart lassen sich Speisen und Getränke zeitgemäss servieren.

Avec les nouveaux assortiments Smart de Bauscher, intelligemment composés, la nourriture et les boissons peuvent être servies de manière contemporaine.



Espresso-Tasse
Tasse à espresso

27552580000 *glasur* 8 cl   4.90



Teller flach coup
Assiette plate coupe

27512215940 *minea* Ø 20 cm   8.65
27512285940 Ø 28 cm   18.35



Espresso-Untertasse
Soutasse à espresso

27569085940 *minea* Ø 12 cm   4.25



Teller tief coup
Assiette creuse coupe

27513245940 *minea* Ø 24 cm   12.75





Kaffee-Tasse
Tasse à café

27552680000 *glasur* 18 cl   6.35



Snackplatte
Plat à snack

27523315940 *minea* 31 x 17 cm   26.60







Kombi-Untertasse
Soutasse combi

27569185940 *minea* Ø 15 cm   5.05



Teller flach coup
Assiette plate coupe

27512215941 *nordic* Ø 20 cm   8.65
27512285941 Ø 28 cm   18.35





Bowl
Bol

27557150000 *glasur* Ø 15 cm   9.85





Teller tief coup
Assiette creuse coupe

27513245941 *nordic* Ø 24 cm   12.75



Snackplatte
Plat à snack

27523315941 *nordic* 31 x 17 cm   26.60



BAUSCHER
GERMANY

luzifer

Die Back-, Auflauf- und Spezialartikel sind so elegant, dass sie nicht nur im Ofen, sondern auch auf dem gedeckten Tisch eine gute Figur machen.

Les plats à gratin, à soufflé et les plats spéciaux sont si élégants qu'ils ont autant leur place au four que sur votre table.



Löwenkopfterrine
Terrine tête de lion

20815045051 45 cl   16.40









Eierplättli rund
Plat à oeufs/gratin ronde

20850019051 19 cm   18.10
20850023051 23 cm   23.25



Souffléform
Ramequin/Moule à soufflé

20622006051 6 cm   8.80
20622007051 7 cm   9.60
20622008051 8 cm   11.70
20622009051 9 cm   13.25

















Kasserolle komplett
Casserole complète

20851031051 30 cl   23.25
20851051051 50 cl   31.70



Backform oval
Plat à gratin ovale

20784022051 22 cm   21.85
20784024051 24 cm   25.15
20784028051 28 cm   35.15
20784032051 32 cm   51.70
20784036051 36 cm   68.20
20784040051 40 cm   88.20
20784044051 44 cm   128.20



Kasserolle (ohne Deckel)
Casserole (sans couvercle)

20851030051 30 cl   13.25
20851050051 50 cl   17.60





Deckel zu Kasserolle
Couvercle pour casserole

20851003051 30 cl   11.70
20851005051 50 cl   14.45



Backform rund
Plat à gratin ronde

20785012051 12 cm   14.80
20785013051 13 cm   18.80
20785015051 15 cm   22.65
20785017051 17 cm   29.80



BAUSCHER
GERMANY

coffeelings

Der schlanke Körper bringt feinen Milchschaum oder Crema mit Kringeln verlockend zur Geltung. Dabei wirkt der schleifenförmig geschwungene Henkel wie ein Schmuckstück.

Le corps élancé fait apparaître de manière tentante une fine mousse de lait ou une crema avec des boucles. En même temps, la poignée en forme de boucle ressemble à un bijou.



Kaffeekanne komplett
Cafetière complète

21414130051	30 cl			37.95
Kaffeekanne Unterteil Cafetière corps				
21414131051	30 cl			26.60
Kaffeekanne Deckel Cafetière couvercle				
21414132051	30 cl			9.85



Teekanne
Théière complète

21414345051	40 cl			46.60
Teekanne Unterteil Théière corps				
21414346051	40 cl			34.90
Teekanne Deckel Théière couvercle				
21414347051	40 cl			11.45



Teesieb schwarz
Passe-thé noir

20144041051	5,5 cm x H 5 cm			20.35
-------------	-----------------	--	--	-------



Cremier
Cremier

21414614051	16 cl			15.05
-------------	-------	--	--	-------



Zuckerdose komplett
Sucrier complet

21415074051	24 cl			22.10
Zuckerdose Unterteil Sucrier corps				
21415075051	24 cl			11.45
Zuckerdose Deckel Sucrier couvercle				
21415076051	24 cl			9.85



Bowl hoch
Bol haute

21416658051	8 cl / Ø 5,8 cm			8.25
-------------	-----------------	--	--	------



Bowl hoch
Bol haute

21415468051	18 cl / Ø 7,3 cm			9.85
-------------	------------------	--	--	------



Bowl
Bol

21415075051	24 cl / Ø 10 cm			11.45
21416680051	30 cl / Ø 10,7 cm			12.75
21416690051	40 cl / Ø 12 cm			15.05



Schälchen
Coupelle

21415710051	Ø 10 cm			7.30
-------------	---------	--	--	------

coffeelings



Espresso-Tasse
Tasse à espresso

21415258051 8 cl  9.85



Espresso-Untertasse
Soutasse à espresso

27113090051 8 cl / Ø 12 cm  5.55



Kaffee-Tasse hoch
Tasse à café haute

21415268051 18 cl  12.25



Kaffee-Tasse
Tasse à café

21415274051 24 cl  13.30
21415280051 30 cl  15.55
21415290051 40 cl  18.10



Mug
Mug

21415678051 28 cl / Ø 7,7 cm  15.05



Mug
Mug

21415679051 29 cl / Ø 8,3 cm  15.05



Kombi-Untertasse
Soutasse multiple

27113081051 18-30 cl / Ø 15 cm  6.35



Untertasse mit 2 Spiegel
Soutasse avec 2 marlis





21416817051 18-40 cl / Ø 16,9 cm  8.35



Untertasse
Soutasse

27113000051 40 cl / Ø 19,1 cm  8.35

dekore/décors

186
skyblue184
stone178
firebrick185
petrol182
greenyellow183
cashmere179
macchiato180
violettred181
dark blue069
sand072
schoko065
grau071
rotbraun066
aubergine067
orange073
flieder070
purpurrot005
black one**Espresso-Tasse**
Tasse à espresso21415258xxx 8 cl   15.30**Kombi-Untertasse**
Soutasse multiple21716918xxx 18-30 cl / Ø 15 cm   11.45**Espresso-Untertasse**
Soutasse à espresso21716909xxx 8 cl / Ø 12 cm   9.55**Untertasse mit 2 Spiegel**
Soutasse avec 2 marlis21416817xxx 18-40 cl / Ø 16,9 cm   13.30**Kaffee-Tasse hoch**
Tasse à café haute21415268xxx 18 cl   19.95**Kaffee-Tasse**
Tasse à café21415274xxx 24 cl   21.70
21415280xxx 30 cl   25.30
21415290xxx 40 cl   28.75**Mug**
Mug21415678xxx 28 cl / Ø 7,7 cm   23.85**Mug**
Mug21415679xxx 29 cl / Ø 8,3 cm   23.85

Untertassen auf Anfrage auch mit Vollfond-Dekor erhältlich.
Soutasses également disponibles sur demande avec décor plein fond.

Sehen Sie alle Artikel einzeln in den erhältlichen
Farben in unserem Onlineshop.
Voir tous les articles séparément dans les
couleurs disponibles dans notre boutique en ligne.





BW **BAUSCHER**
GERMANY

coffee to go

Für alle Heissgetränke gibt es von Bauscher attraktive, moderne Coffee to Go Becher.

Bauscher propose des gobelets modernes et au design attrayant adaptés à toutes les boissons chaudes.



Becher
Gobelet

20195438051 38 cl / Ø 9,4 cm x H 13 cm 12.75



Deckel schwarz
Couvercle noir

20190021105 10 cm 4.25



Deckel weiss
Couvercle blanc

20190021060 10 cm 4.25



Manschette schwarz
Manchette noir

20190028105 9 cm 3.15



Manschette weiss
Manchette blanc

20190028060 9 cm 3.15





BW BAUSCHER
GERMANY

little world

Die Kinderserie von Berndorf Luzern nimmt die Kinder mit auf eine Fantastische Reise durch 4 Zauberverwelten.

La gamme de Berndorf Lucerne emmène les enfants sur un voyage à incroyable travers quatres mondes magiques.



Teller Porzellan
Assiette porcelaine

LITTLEWORLD9000 Ø 25,5 cm

34.90



Bébételler Porzellan
Assiette de bébé porcelaine

BEBE900 Ø 17 cm

31.95



Tischset zum Ausmalen und Spielen 40 Stk.
Sets de table pour coloriage et pour jouer 40 pcs.

BLOCK700 41 x 30 cm

8.50



 **BAUSCHER**
GERMANY

system

Funktion, Qualität und Design für den täglichen Dauereinsatz. Systemporzellan für Krankenhäuser und Heime.

Fonction, qualité et design pour l'usage quotidien et durable. Porcelaine coordonnée pour les hôpitaux et les homes.

**Portionskanne**
Cafetière
«Krankenhaus»

21197035051	33 cl / H 8,5 cm			29.55
418146300	Deckel/Couvercle Typ «A»			6.15
418145300	Deckel/Couvercle Typ «E»			6.15

**Cremier stapelbar**
Crémier empilable
«B1100»

21102004051	4 cl / H 4,5 cm			8.65
-------------	-----------------	--	--	------

**Milchkanne stapelbar**
Pot à lait empilable
«B1100»

21102015051	13 cl / H 7,3 cm			15.05
-------------	------------------	--	--	-------

**Milchkanne stapelbar**
Pot à lait empilable
«B1100»

21102050051	50 cl / H 13,9 cm			29.55
-------------	-------------------	--	--	-------

**Zuckerschale**
Coupelle à sucre
«B1100»

21120008051	Ø 7,9 cm x H 1,7 cm			4.35
-------------	---------------------	--	--	------

**Butterschale**
Coupelle à beurre
«B1100»

21122008051	Ø 7,6 cm x H 3,6 cm			7.15
418104300	Deckel/Couvercle Typ «A»			4.30

**Marmeladenschale**
Coupelle à confiture
«B1100»

21108008051	Ø 7,8 cm x H 2,6 cm			5.85
418104300	Deckel/Couvercle Typ «A»			4.30

**Eierbecher**
Coquetier
«B1100»

29302000051	Ø 4 cm x H 4 cm			6.65
-------------	-----------------	--	--	------

**Setplatte breit**
Plat rectangulaire
«B1100»

29400000051	25,5 x 12,7 cm			26.60
-------------	----------------	--	--	-------

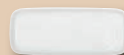
**Setplatte mit 2 Spiegel**
Plat avec 2 marlis
«Krankenhaus»

25912623051	24,5 x 10,1 cm			25.30
-------------	----------------	--	--	-------

**Setplatte mit 2 Spiegel**
Plat avec 2 marlis
«Krankenhaus»

25912622051	23,6 x 9,6 cm			24.75
418174300	Haube/Bonnet Typ «N»			13.30
418175300	Haube/Bonnet Typ «M»			18.35

**Tasse stapelbar**
Tasse à café empilable
«B1100»

21113018051	19 cl			9.85
-------------	-------	--	--	------

*passend: Kombi-Untertasse, Setplatte breit, Setplatte mit 2 Spiegel**compatible: Soutasse multiple + Plat rectangulaire + Plat avec 2 marlis***Tasse stapelbar**
Tasse à café empilable
«B1100»

21110018051	18 cl			9.85
-------------	-------	--	--	------

**Tasse hoch stapelbar**
Tasse à café haut empilable
«B1100»

21114019051	22 cl			11.45
-------------	-------	--	--	-------

**Becher**
Chope
«B1100»

21114026051	27 cl			11.95
418176300	Deckel/Couvercle Typ «A»			4.25

*passend: Kombi-Untertasse, Setplatte breit, Setplatte mit 2 Spiegel**compatible: Soutasse multiple + Plat rectangulaire + Plat avec 2 marlis***Suppentasse stapelbar**
Tasse à consommé empilable
«B1100»

21140026051	25 cl			13.30
-------------	-------	--	--	-------

**Kombi-Untertasse**
Soutasse multiple
«B1100»

21110081051	18-27 cl / Ø 13,8 cm			6.50
-------------	----------------------	--	--	------



system



Espressotasse stapelbar
Tasse à espresso empilable
«6200»

26215010051 10 cl 8.65



Espresso Untertasse
Soutasse à espresso
«6200»

26214001051 10 cl / Ø 12,1 cm 5.55



Tasse Obere stapelbar
Tasse à café empilable
«6200»

26215018051 18 cl 9.55
26215022051 21 cl 11.15



Suppentasse stapelbar
Tasse à consommé empilable
«6200»

26257026051 26 cl 12.75



Trinkbecher mit Henkel
Chope avec anse
«Krankenhaus»

21118030051 30 cl 13.30
418176300 Deckel/Couvercle Typ «A» 4.25

passend: Kombi-Untertasse 6200 + Setplatte mit 2 Spiegel
compatible: Soutasse multiple 6200 + Plat avec 2 maris



Kombi-Untertasse
Soutasse multiple
«6200»

26214081051 18-26 cl / Ø 13,9 cm 6.50



Becher
Gobelet
«Krankenhaus»

25956300051 30 cl 11.95



Teller flach Fahne
Assiette plate avec aile
«B1100»

21150017051 Ø 17,2 cm 9.55
21150019051 Ø 18,8 cm 10.60
21150021051 Ø 20,4 cm 13.30
21150023051 Ø 22,9 cm 15.05
21150024051 Ø 23,8 cm 16.50
21150028051 Ø 27,9 cm 22.10



Systemteller flach Fahne
Assiette système plate avec aile
«B1100»

21150025051 Ø 25,7 cm 16.50



Teller flach coup
Assiette plate coupe
«6200»

26250017051 Ø 17,0 cm 9.55
26250019051 Ø 19,2 cm 10.60
26250021051 Ø 21,0 cm 12.75
26250024051 Ø 24,0 cm 15.85
26250027051 Ø 27,0 cm 20.35



Systemteller flach coup
Assiette système plate coupe
«6200»

26250025051 Ø 25,7 cm 15.85



Teller flach coup
Assiette plate coupe
«Options»

25950025051 Ø 25,4 cm 16.75



Teller flach coup
Assiette plate coupe
«Krankenhaus»

25912240051 Ø 23 cm 16.50



Teller flach coup
Assiette plate coupe
«B1100»

21151023051 Ø 23 cm 15.05



Systemteller halbtief Fahne
Assiette système demi-creuse avec aile
«Krankenhaus»

25954052051 Ø 25,7 cm 18.60



Systemteller halbtief coup
Assiette système demi-creuse coup
«Krankenhaus»

25952052051 Ø 25,7 cm 18.60



Systemteller tief coup
Assiette système creuse coupe
«Krankenhaus»

25959052051 Ø 25,7 cm 18.60



Teller tief coup
Assiette creuse coupe
«6200»

26250012051 Ø 20,9 cm   13.30





Teller tief Fahne
Assiette creuse avec aile
«B1100»

21150022051 Ø 21,4 cm   15.05





Teller flach rund 2-teilig
Assiette plate rond à 2 compartiments
«Krankenhaus»

25926330051 Ø 22,5 cm   24.75





Systemteller flach rund 2-teilig
Assiette système plate à 2 compartiments
«Krankenhaus»

25786025051 Ø 25,7 cm   26.60





Systemteller flach rund 2-teilig
Assiette système plate à 2 compartiments
«Krankenhaus»

25787025051 Ø 25,7 cm   26.60





Systemteller flach rund 3-teilig
Assiette système plate à 3 compartiments
«Krankenhaus»

25924290051 Ø 25,7 cm   26.60





Systemteller flach rund 3-teilig
Assiette système plate à 3 compartiments
«Krankenhaus»

25224025051 Ø 25,7 cm   26.60











Systemteller flach rund 3-teilig
Assiette système plate à 3 compartiments
«Krankenhaus»

25924028051 Ø 25,7 cm   26.60











Eintopfschale
Cocotte
«B1100»

21182019051 110 cl / Ø 19,4 x H 5,8 cm   28.25
418194300 Deckel/Couvercle Typ «A»   12.75
418195300 Deckel/Couvercle Typ «B»   22.60
418196300 Deckel/Couvercle Typ «C»   25.30











Eintopfschale rund stapelbar
Cocotte rond empilable
«Krankenhaus»

22154021051 115 cl / Ø 21,6 x H 5,1 cm   29.30
418207300 Deckel/Couvercle Typ «A»   13.30
418208300 Deckel/Couvercle Typ «B»   28.25
418209300 Deckel/Couvercle Typ «C»   26.60







Saladier rund stapelbar
Saladier rond empilable
«6200»

26280018051 85 cl / Ø 17,4 x H 5,2 cm   22.60
418142300 Deckel/Couvercle Typ «A»   12.75
418203300 Deckel/Couvercle Typ «B»   21.05
418204300 Deckel/Couvercle Typ «C»   22.60



Eintopfschale rund stapelbar
Cocotte rond empilable
«B1100»

21156090051 93 cl / Ø 18,5 x H 7 cm   24.75
418127300 Deckel/Couvercle Typ «A»   6.50











Suppenschale stapelbar
Bol à soupe empilable
«B1100»

21156030051 30 cl / Ø 12 x H 5,5 cm   12.50











Suppenschale stapelbar
Bol à soupe empilable
«B1100»

21156040051 47 cl / Ø 15 x H 5,6 cm   13.30
418134300 Deckel/Couvercle Typ «A»   8.35
418183300 Deckel/Couvercle Typ «B»   15.55
418133300 Deckel/Couvercle Typ «C»   13.30



Suppenschale stapelbar
Bol à soupe empilable
«B1100»

21156050051 53 cl / Ø 15 x H 6,7 cm   16.75
418134300 Deckel/Couvercle Typ «A»   8.35
418183300 Deckel/Couvercle Typ «B»   15.55
418133300 Deckel/Couvercle Typ «C»   13.30



system



Suppenschale stapelbar
Bol à soupe empilable
«Krankenhaus»

25931140051	47 cl / Ø 12,5 x H 5,7 cm			12	13.30
418138300	Deckel/Couvercle Typ «A»			6	9.85
418190300	Deckel/Couvercle Typ «C»			6	15.55



Suppenschale stapelbar
Bol à soupe empilable
«Krankenhaus»

25965140051	47 cl / Ø 14 x H 5,2 cm			12	16.50
418305300	Deckel/Couvercle Typ «A»			6	11.15
418306300	Deckel/Couvercle Typ «B»			6	15.30



Suppenschale stapelbar
Bol à soupe empilable
«Krankenhaus»

25980033051	38 cl / Ø 11,9 x H 6,4 cm			12	13.30
418188300	Deckel/Couvercle Typ «A»			6	8.35
418192300	Deckel/Couvercle Typ «B»			6	12.75
418190300	Deckel/Couvercle Typ «C»			6	15.55



Suppenschale stapelbar
Bol à soupe empilable
«Krankenhaus»

25950711051	29 cl / Ø 10,3 x H 5,5 cm			6	12.25
418259300	Deckel/Couvercle Typ «A»			6	7.55
418128300	Deckel/Couvercle Typ «B»			6	13.30
418187300	Deckel/Couvercle Typ «C»			6	13.30



Teller flach quadratisch
Assiette plate carrée
«Krankenhaus»

22152023051	18,5 x 18,5 cm			12	15.85
418180300	Haube/Bonnet Typ «O»			6	22.60



Teller flach quadratisch
Assiette plate carrée
«Krankenhaus»

22152027051	19,9 x 19,9 cm			12	19.95
418232300	Haube/Bonnet Typ «P»			6	25.30



Teller flach quadratisch
Assiette plate carrée
«B1100»

21152012051	9,5 x 9,5 cm			24	5.15
21152019051	15,2 x 15,2 cm			12	9.55
21152029051	21,5 x 21,5 cm			6	18.10



Platte rechteckig
Plat rectangulaire
«Krankenhaus»

22162016051	16,4 x 11,8 cm			10	13.30
418214300	Haube/Bonnet Typ «N»			6	13.30



Platte rechteckig
Plat rectangulaire
«B1100»

21162018051	18,1 x 11,9 cm			6	15.85
418173300	Haube/Bonnet Typ «N»			6	15.55



Platte rechteckig
Plat rectangulaire
«B1100»

21162021051	21,6 x 14,3 cm			6	20.35
-------------	----------------	--	--	---	-------



Platte rechteckig mit Mittelsteg
Plat rectangulaire avec barre centrale
«B1100»

21123220051	21,6 x 14,1 cm			6	22.60
-------------	----------------	--	--	---	-------



Platte rechteckig
Plat rectangulaire
«B1100»

21162030051	30,5 x 15,0 cm			6	34.90
-------------	----------------	--	--	---	-------



Schale quadratisch stapelbar
Coupe carré empilable
«Krankenhaus»

22181015051	30 cl / 11,7 x 11,7 cm			11.45
418152300	Deckel/Couvercle Typ «H»			9.30
418151300	Deckel/Couvercle Typ «I»			9.05
418230300	Deckel/Couvercle Typ «J»			9.05



Schale quadratisch stapelbar
Coupe carré empilable
«B1100»

21181014051	23 cl / 11,2 x 11,2 cm			9.85
418150300	Deckel/Couvercle Typ «G»			9.05
418119300	Deckel/Couvercle Typ «H»			8.35



Schale quadratisch stapelbar
Coupe carré empilable
«B1100»

21181015051	27 cl / 12,1 x 12,1 cm			11.15
-------------	------------------------	--	--	-------



Schale rechteckig
Coupe rectangulaire
«Krankenhaus»

29401019051	49 cl / 18,3 x 12,2 cm			18.35
418173300	Haube/Bonnet Typ «N»			15.55



Schale rechteckig
Coupe rectangulaire
«Krankenhaus»

29403011051	18 cl / 11,4 x 8,2 cm			11.15
418102300	Deckel/Couvercle Typ «L»			8.35



Kompottschale rund stapelbar
Compotier rond empilable
«6200»

26289012051	27 cl / Ø 11,9 cm			10.60
418110300	Deckel/Couvercle Typ «D»			9.05



Bowl rund stapelbar
Bol ronde empilable
«Krankenhaus»

22180013051	40 cl / Ø 13,5 cm			13.30
418134300	Deckel/Couvercle Typ «A»			8.35



Bowl rund stapelbar
Bol ronde empilable
«Krankenhaus»

22161130051	37 cl / Ø 12,5 cm			13.30
-------------	-------------------	--	--	-------



Bowl rund stapelbar
Bol ronde empilable
«B1100»

21158013051	31 cl / Ø 13 cm			11.95
418172300	Deckel/Couvercle Typ «A»			9.85



Bowl rund stapelbar
Bol ronde empilable
«6200»

26257000051	25 cl / Ø 9,9 cm			10.90
-------------	------------------	--	--	-------



Bowl rund stapelbar
Bol ronde empilable
«Krankenhaus»

22158012051	37 cl / Ø 12 cm			13.30
418110300	Deckel/Couvercle Typ «D»			9.05



Saladier rund stapelbar
Saladier rond empilable
«6200»

26280012051	34 cl / Ø 11,5 cm			12.75
418110300	Deckel/Couvercle Typ «D»			9.05



system
quadrosystem
quadro

Teller flach eckig mit Stern
Assiette plate angulaire avec étoile
«Quadro»

29550025051	25 x 22,5 cm			18.35
418216300	Cloche Typ «Q»			22.60
418217300	Cloche Typ «R»			28.25



Teller flach eckig
Assiette plate angulaire
«Quadro»

29550052051	25 x 22,5 cm			18.35
418216300	Cloche Typ «Q»			22.60
418217300	Cloche Typ «R»			28.25



Eintopfschale
Cocotte
«Quadro»

29580017051	78 cl / Ø 16,3 cm			22.10
-------------	-------------------	--	--	-------



Suppenschale
Bol à soupe
«Quadro»

29556045051	48 cl / Ø 12,5 cm			16.75
418138300	Deckel/Couvercle Typ «A»			9.85
418190300	Deckel/Couvercle Typ «C»			15.55



Saladier quadratisch
Saladier carrée
«Quadro»

29581012051	16 cl / 10 x 10 cm			9.30
-------------	--------------------	--	--	------



Schale rechteckig
Coupelle rectangulaire
«Quadro»

29588010051	8 cl / 10 x 6,5 cm			7.30
-------------	--------------------	--	--	------







Schale rechteckig
Coupelle rectangulaire
«Quadro»

29588017051	30 cl / 17 x 10 cm			12.75
-------------	--------------------	--	--	-------



Schale rechteckig
Coupelle rectangulaire
«Quadro»

29588020051	38 cl / 20,3 x 9,9 cm			13.30
-------------	-----------------------	--	--	-------

system
dimension**Systemteller flach**
Assiette système plate29000625051 Ø 25,7 cm   18.35**Kompottschale**
Compotier29030062051 27 cl / Ø 12 cm   11.95
418110300 **Deckel/Couvercle Typ «D»**   9.05

Ergänzt die Serie «Dimension» auf den Seiten 78-81.
Complété la série «Dimension» sur les pages 78-81.

system
dialogsystem
dialog**Portionskanne**
Cafetière

28095035051	37 cl			28.25
418146300	Deckel/Couvercle Typ «A»			6.15
418145300	Deckel/Couvercle Typ «E»			6.15

**Trinkbecher mit Henkel**
Chope avec anse

28019026051	26 cl			13.30
418104300	Deckel/Couvercle Typ «A»			4.30

**Systemteller flach**
Assiette système plate

28049025051	Ø 25,7 cm			18.35
-------------	-----------	--	--	-------

**Systemteller flach rund 3-teilig**
Assiette système plate à 3 compartiments

28024025051	Ø 25,7 cm			26.60
-------------	-----------	--	--	-------

**Kompottschale rund stapelbar**
Compotier rond empilable

28089012051	28 cl / Ø 12,2 cm			12.75
418110300	Deckel/Couvercle Typ «D»			9.05

**Suppenschale stapelbar**
Bol à soupe empilable

28058012051	38 cl / Ø 12,0 cm			15.05
418110300	Deckel/Couvercle Typ «D»			9.05

**Eintopfschale stapelbar**
Cocotte empilable

28058017051	94 cl / Ø 16,8 cm			26.60
418194300	Deckel/Couvercle Typ «A»			12.75
418195300	Deckel/Couvercle Typ «B»			22.60
418196300	Deckel/Couvercle Typ «C»			25.30

**Suppenschale**
Bol à soupe

28056050051	53 cl			19.95
418134300	Deckel/Couvercle Typ «A»			8.35
418183300	Deckel/Couvercle Typ «B»			15.55
418133300	Deckel/Couvercle Typ «C»			13.30

**Suppenschale schwappsicher**
Bol à soupe anti-débordante

28057120051	43 cl / Ø 12,2 x H 6,3 cm			19.95
418188300	Deckel/Couvercle Typ «A»			8.35
418192300	Deckel/Couvercle Typ «B»			12.75

**Schale quadratisch stapelbar**
Coupelle carré empilable

28032140051	25 cl / 11,6 x 11,6 cm			11.15
418152300	Deckel/Couvercle Typ «H»			9.30
418151300	Deckel/Couvercle Typ «I»			9.05
418230300	Deckel/Couvercle Typ «J»			9.05

**Platte rechteckig tief**
Plat rectangulaire creux

28058180051	18,6 x 12,2 cm			18.60
418173300	Haube/Bonnet Typ «N»			15.55

Ergänzt die Serie «Dialog» auf den Seiten 82-85.
Complété la série «Dialog» sur les pages 82-85.



system carat







Systemteller
Assiette système

22549025051 25,7 cm   15.55











Kompottschale rund
Compotier rond

22585012051 33 cl / Ø 12,3 cm   11.15
418110300 Deckel/Couvercle Typ «D»   9.05







Eintopfschale
Cocotte

22584018051 90 cl / Ø 18 cm   22.60
418142300 Deckel/Couvercle Typ «A»   12.75
418203300 Deckel/Couvercle Typ «B»   21.05
418204300 Deckel/Couvercle Typ «C»   22.60











Suppenschale stapelbar
Bol à soupe empilable

22558012051 38 cl / Ø 11,9 cm   12.75
418110300 Deckel/Couvercle Typ «D»   9.05











Suppenschale stapelbar
Bol à soupe empilable

22556040051 47 cl / Ø 15,1 cm   15.05
418134300 Deckel/Couvercle Typ «A»   8.35
418183300 Deckel/Couvercle Typ «B»   15.55
418133300 Deckel/Couvercle Typ «C»   13.30



Suppenschale stapelbar
Bol à soupe empilable

22556050051 53 cl / Ø 15,1 cm   21.05
418134300 Deckel/Couvercle Typ «A»   8.35
418183300 Deckel/Couvercle Typ «B»   15.55
418133300 Deckel/Couvercle Typ «C»   13.30

*Ergänzt die Serie «Carat» auf den Seiten 86-89.
Complète la série «Carat» sur les pages 86-89.*



system
invitasystem
invita

Spezialbecher
Gobelet spécial
«invita dimension»

29005331051 30 cl 19.95
418176300 Deckel/Couvercle Typ «A» 4.25



Spezialbecher
Gobelet spécial
«invita dialog»

28010028051 27 cl 13.30
418176300 Deckel/Couvercle Typ «A» 4.25



Spezial-Untertasse mit 2 Spiegel
Soutasse spécial avec 2 marlis
«invita dimension»

29007118051 18-30 cl / Ø 16,5 cm 7.70



Spezial-Untertasse mit 2 Spiegel
Soutasse spécial avec 2 marlis
«invita dialog»

28010082051 18-30 cl / Ø 16,5 cm 7.70



Spezialteller tief Fahne
Assiette spécial creuse avec aile
«invita dimension»

29001730051 Ø 23 cm 26.60



Spezialteller tief Fahne
Assiette spécial creuse avec aile
«invita dialog»

28050004051 Ø 23,0 cm 18.10



Spezialteller halbtief Fahne
Assiette spécial demi-creuse avec aile
«invita dimension»

29002240051 Ø 23,9 cm 18.10



Spezialteller halbtief Fahne
Assiette spécial demi-creuse avec aile
«invita dialog»

28002240051 Ø 23,9 cm 18.10



Spezialteller halbtief Fahne
Assiette spécial demi-creuse avec aile
«invita dimension»

29002250051 Ø 25,7 cm 18.35



Spezialteller halbtief Fahne
Assiette spécial demi-creuse avec aile
«invita dialog»

28002250051 Ø 25,7 cm 19.95

Ergänzt die Serie «Dimension» auf den Seiten 78-81.
Complète la série «Dimension» sur les pages 78-81.

Ergänzt die Serie «Dialog» auf den Seiten 82-85.
Complète la série «Dialog» sur les pages 82-85.

dekore/décors

Farb-Dekore auf Anfrage
Décors en couleur sur demande



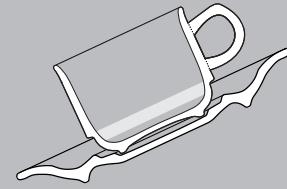

> Doppelter Fussring/Kippschutz
Double anneau/prevention de basculement

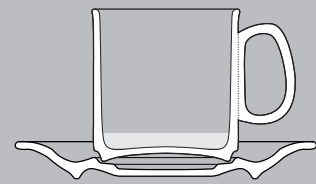

> Extra grosser verstärkter Henkel/sicheres Greifen
Poignée extra large/acées sécurisé



> Mehrfachnutzen durch Doppelspiegel
Utilisation multiple cause du double miroire

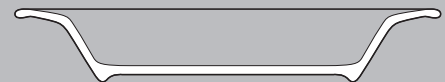

> Erhöhter Tellerrand/sichere Speiseaufnahme
Bord de l'assiette augmenté/alimentations sécurisé



> Breiter Tellerfuss/Standfestigkeit
Large base de assiette/stabilité

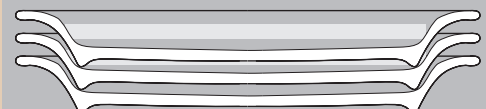

> Sicher und platzsparend stapelbar
Empilable encombrant

Menschen im Senioren- und Pflegebereich sind in ihren Bewegungen und ihrer Wahrnehmung oftmals eingeschränkt. Die Möglichkeit einer eigenständigen, sicheren Speisenaufnahme stellt daher eine besondere Herausforderung bei ihrer Versorgung dar.

Dimension invita und Dialog invita:

Die beiden Spezialsortimente von Bauscher in glatter bzw. reliefierter Ausführung sind genau auf die Bedürfnisse dieser Menschen abgestimmt. Für ein genussvolles Speiseerlebnis verbinden sie eine durchdachte ergonomische Gestaltung mit ansprechendem Design. Die Spezialartikel überzeugen durch besondere funktionale Details. Sie ermöglichen Menschen mit körperlichen Einschränkungen, problemloser zu speisen – so können sie aktiver und mit mehr Freude am Leben teilnehmen.

Les personnes âgées au les personnes en soins infirmiers sont souvent limité dans leurs mouvement. La possibilité de pouvoir gérer la consommation d'aliments peu être un vrais deficit.

Dimension invita et Dialog invita:

Les deux asortiments de Bauscher avec une finition en relief ou lisse sont fabriqué spécialement pour les besoins des personnes avec un handicap. La forme ergonomique avec un design attirant pour une prise de repas agreable.

Les details fonctionnels des articles sont convaincante. Elle permet au personnes âgée ou hanicapé de prendre leurs repas tout facilement et leur permet d'avoir plus de plaisir dans la vie cotidienne.

Farben/Couleurs

Punkte

Sonnengelb	
Apfelgrün	
Wasserblau	
Kirschrot	
Himbeerrot	

Struktur

Sonnengelb	
Apfelgrün	
Terrakotta	
Wasserblau	

Pinselfband

Sonnengelb	
Apfelgrün	
Mintgrün	
Rubinrot	
Bordeauxrot	
Lachsrot	
Orange	
Himmelblau	
Marineblau	
Aubergine	



system
induktion/inductionsystem
induktion/induction

Teller flach eckig mit Stern
Assiette plate angulaire avec étoile
«Quadro»

29550026051	25 x 22,5 cm			38.60
418216300	Cloche Typ «Q»			22.60
418217300	Cloche Typ «R»			28.25



Systemteller flach
Assiette système plate
«B1100»

21150026051	25,7 cm			43.95
-------------	---------	--	--	-------



Teller flach eckig
Assiette plate angulaire
«Quadro»

29550053051	25 x 22,5 cm			38.60
418216300	Cloche Typ «Q»			22.60
418217300	Cloche Typ «R»			28.25



Eintopfschale
Cocotte
«B1100»

21182020051	110 cl / Ø 19,4 x H 5,8 cm			49.30
418194300	Deckel/Couvercle Typ «A»			12.75
418195300	Deckel/Couvercle Typ «B»			22.60
418196300	Deckel/Couvercle Typ «C»			25.30



Suppenschale
Bol à soupe
«Quadro»

29556046051	48 cl / Ø 12,5 cm			41.95
418138300	Deckel/Couvercle Typ «A»			9.85
418190300	Deckel/Couvercle Typ «C»			15.55



Eintopfschale
Cocotte
«Quadro»

29580018051	78 cl / Ø 16,3 cm			55.95
-------------	-------------------	--	--	-------

- Gleichbleibend hohe laborgetestete Qualität (Fertigung in Deutschland)
- Optimale Systempassfähigkeit
Ständige Weiterentwicklung in Zusammenarbeit mit den Systemherstellern
- Unübertroffene Kantenschlagfestigkeit
z. B. durch verstärkte Borde und Ränder
- Höchste Abrieb- und Schnittfestigkeit der Glasoberfläche
- Perfekte Funktionalität z. B. neue schwappsichere Suppenschale
- Glasierte Borde bzw. fein polierte Borde und Füße
dadurch keine Einschmutzung und kein Verkratzen beim Stapeln
- Optimale raumsparende Stapelung dadurch weniger Bruch,
leichteres Handling und oftmals weniger Staplergeräte
- Höchste Wärmespeicherfähigkeit; durch stärkere Wandung der
Nutzflächen bleibt Heißes länger heiss und Kaltes länger kalt.
- Spülmaschinengerechte Formen, keine Schmutzecken
- Optimale Wärmeverteilung durch hohe Gleichmässigkeit der
Beschichtung
- Mindestens 15 Jahre Nachkaufgarantie

- Haute qualité constante testée en laboratoire (fabrication en Allemagne)
- Compatibilité optimale avec d'autres systèmes (développement constant en collaboration avec les fabricants des systèmes)
- Résistance inégalée contre les ébréchures (p.ex. par des bords renforcés)
- Haute résistance de la glaçure contre l'abrasion et les rayures
- Hautement fonctionnel (p.ex. nouveau bol à soupe anti-éclaboussure)
- Bords émaillés, plus précisément bords et pieds finement polis de ce fait pas de saleté ou rayures lors de l'empilage
- Empilage optimal pour un faible encombrement de ce fait, moins de casse, un maniement plus facile et souvent moins d'appareils de stockage.
- Haute capacité de récupération de chaleur par des parois plus épaisses de la surface exploitable, le chaud reste plus longtemps chaud et le froid plus longtemps froid.
- Design adapté au lave-vaisselle, pas de coin à saleté
- Distribution de chaleur optimale par la grande régularité du revêtement
- Garantie de réassort de 15 ans au minimum



Suppenschale stapelbar
Bol à soupe empilable
«B1100»

21156041051*	47 cl / Ø 15 x H 5,6 cm			25.30
418134300	Deckel/Couvercle Typ «A»			8.35
418183300	Deckel/Couvercle Typ «B»			15.55
418133300	Deckel/Couvercle Typ «C»			13.30



Suppenschale stapelbar
Bol à soupe empilable
«Krankenhaus»

25950712051	10,3 cm / 29 cl			26.60
418259300	Deckel/Couvercle Typ «A»			7.55
418128300	Deckel/Couvercle Typ «B»			13.30
418187300	Deckel/Couvercle Typ «C»			13.30



Suppenschale schwappsicher
Bol à soupe anti-débordante
«Krankenhaus»

25957013051*	43 cl / Ø 12,2 x H 6,3 cm			41.95
418188300	Deckel/Couvercle Typ «A»			8.35
418192300	Deckel/Couvercle Typ «B»			12.75



Suppenschale stapelbar
Bol à soupe empilable
«System»

29555046051	45 cl			34.25
418259300	Deckel/Couvercle Typ «A»			7.55



Suppenschale stapelbar
Bol à soupe empilable
«Carat»

22556041051*	47 cl / Ø 15,1 cm			26.60
418134300	Deckel/Couvercle Typ «A»			8.35
418183300	Deckel/Couvercle Typ «B»			15.55
418133300	Deckel/Couvercle Typ «C»			13.30

* Nicht geeignet für «Cook and Chill»
Pas approprié pour «Cook and Chill»



Systemteller flach rund 3-teilig
Assiette système plate à 3 compartiments
«Krankenhaus»

25224026051	Ø 25,7 cm			49.95
-------------	-----------	--	--	-------



Systemteller flach
Assiette système plate
«Carat»

22549026051	Ø 25,7 cm			41.95
-------------	-----------	--	--	-------



Systemteller flach
Assiette système plate
«Dialog»

28049026051	Ø 25,7 cm			43.95
-------------	-----------	--	--	-------



Systemteller flach rund 3-teilig
Assiette système plate à 3 compartiments
«Dialog»

28024026051	Ø 25,4 cm			49.95
-------------	-----------	--	--	-------



Systemteller flach
Assiette système plate
«Options»

25950026051	Ø 25,4 cm			37.95
-------------	-----------	--	--	-------



Systemteller flach
Assiette système plate
«Dimension»

29000626051	Ø 25,7 cm			34.45
-------------	-----------	--	--	-------



system

deckel/couvercles

Als Ergänzung zum bestehenden Porzellansortiment bietet Bauscher verschiedenste Ausführungen an Geschirrdeckeln aus hochwertigen Kunststoffen für alle am Markt gängigen Speisenverteil-systeme an.

Pour compléter l'assortiment porcelaine existant, Bauscher offre différents modèles de couvercles en matière plastique haut de gamme pour tous les systèmes de distribution de repas.

**Deckel-Ausführungen:
Variantes des couvercles:**

- Typ «A» Kunststoffdeckel grau, rund
Couvercle plastifié gris, rond
- Typ «B» Kunststoffdeckel grau, rund, hochtemp. best.
Couvercle plastifié gris, rond, résistant à haut temp.
- Typ «C» Kunststoffdeckel grau, rund, weich, schwappsicher
Couvercle plastifié gris, malléable, anti-déborderante
- Typ «D» Kunststoffdeckel transparent, rund
Couvercle plastifié transparente, rond
- Typ «E» Kunststoffdeckel braun, rund
Couvercle plastifié brun, rond
- Typ «G» Kunststoffdeckel transparent, hoch, quadratisch
Couvercle plastifié transparent, haut, carrée
- Typ «H» Kunststoffdeckel transparent-blau, hoch, quadratisch
Couvercle plastifié transparent-bleu, haut, carrée
- Typ «I» Kunststoffdeckel transparent-blau, flach, quadratisch
Couvercle plastifié transparent-bleu, plat, carrée
- Typ «J» Kunststoffdeckel milchig-transparent, flach, quadratisch
Couvercle plastifié transparent, plat, carrée
- Typ «K» Kunststoff-Kühldeckel grau, hoch, quadratisch
Couvercle réfrigérierique plastifié gris, haut, carrée
- Typ «L» Kunststoffdeckel transparent-blau, hoch, rechteckig
Couvercle plastifié transparent-bleu, haut, rectangulaire
- Typ «M» Kunststoff-Abdeckhaube transparent, hoch, rechteckig
Bonnet plastifié transparent, haut, rectangulaire
- Typ «N» Kunststoff-Abdeckhaube transparent-blau, hoch, rechteckig
Bonnet plastifié transparent-bleu, haut, rectangulaire
- Typ «O» Kunststoff-Abdeckhaube transparent-blau, quadratisch
Bonnet plastifié transparent-bleu, carrée
- Typ «P» Kunststoff-Abdeckhaube milchig-transparent, quadratisch
Bonnet plastifié transparent, carrée
- Typ «Q» Kunststoff-Cloche mit Griff milchig-transparent
Cloche plastifié avec anse, transparent
- Typ «R» Kunststoff-Cloche mit Griff grau, hochtemp. best.
Cloche plastifié avec anse gris, résistant à haut temp.



**Tellerclochen**

Hygienische Tellerabdeckung - mit Griffleiste für ein besseres Handling in vielen Grössen und verschiedenen hohen Ausführungen für noch mehr Flexibilität.

Kunststoffdeckel transparent-blau

Präsentieren kalte Speisen optisch ansprechend und frisch.

Kühldeckel

Speziell eingearbeitetes Kühlmittel hält Speisen länger kalt.

Deckel mit Stapelnocken bzw. Abstandshaltern

Bessere Luftzirkulation für schnelles Abtrocknen nach dem Spülen und standsicheres Stapeln.

Abdeckhaube milchig-transparent

Eine weitere unempfindliche Variante.

Kaffee-Kuchen-Set

Ein kompaktes, hygienisches Nachmittagsdeck.

Stapelbarkeit

Universalplatten mit Deckel lassen sich auch beim Transport bequem übereinander stapeln und nutzen so den Platz auf dem Tablett optimal.

Deckel mit strukturierter Deckeloberfläche

Gebrauchsspuren sind weniger sichtbar.

Spezialdeckel für Portionskännchen und Becher

Praktischer Schutz für Getränke.

Cloches pour assiettes

Couvercle hygiénique pour assiettes - avec une poignée pour une meilleure manipulation, nombreuses dimensions et modèles de différentes hauteurs pour encore plus de flexibilité.

Couvercles en plastique bleu-transparent

Présentent les plats froids de manière appétissante et fraîche.

Couvercles réfrigérants

Le réfrigérant spécial conserve les aliments froids plus longtemps.

Couvercles avec ergots d'empilage ou entretoises

Meilleure circulation de l'air pour un séchage rapide après le rinçage et un empilage stable.

Couvercle opale-transparent

Une autre variante résistante.

Set pour le goûter

Un service compact et hygiénique pour le goûter.

Aptitude à l'empilage

Les plats universels avec couvercle peuvent être empilés les uns sur les autres de manière pratique, même pour le transport, et utilisent donc l'espace sur le plateau de manière optimale.

Couvercles avec surface structurée

Les traces d'utilisation sont moins visibles.

Couvercles spéciaux pour verseuses et tasses

Protection pratique pour les boissons.

system

warmhaltesystem /
système isothermique

Das Caldomet Warmhaltesystem ist kompatibel mit allen System-Porzellantellern der Grösse 25,7 cm.

Die Warmhaltezeit kann bis 45 Minuten betragen. Der Warmhalteteller kann gekühlt auch als Kühlteller verwendet werden.



Le système isothermique de Caldomet est compatible avec toutes les assiettes système de dimension 25,7 cm.

Le temps de conservation de la température peut aller jusqu'à 45 minutes. L'assiette calorifuge refroidie fonctionne aussi pour garder le froid.

Spülmaschinenfest, korrosionsbeständig und rostfrei.
Convient au lave-vaisselle, anticorrosive et inox.



Cloche mit Loch hoch, Inox
Cloche haute avec trou, inox
«Caldissimo»

625001101 26,3 cm x H 5,2 cm   55.45



Cloche mit Loch nieder, Inox
Cloche basse avec trou, inox
«Caldissimo»

625012101 26,3 cm x H 3,8 cm   49.80



Cloche mit Stapelknopf, Inox
Cloche avec poignée pour empiler, inox
«Caldissimo»

640378101 26,5 cm x H 4,5 cm   78.55



Wärmeteller, Inox
Assiette calorifuge, inox
«Caldissimo»

625055101 25 cm   82.10



Wärmekernteller, Inox
Assiette calorifuge, inox
«Variomet»

640329101 25 cm   104.20



Kunststoff-Cloche
Cloche synthétique
«Quadro»

625034304 22,5 cm x H 4,5 cm   39.80



Kunststoff-Cloche
Cloche synthétique
«Caldoset»

625031301 26,5 cm x H 5,3 cm   38.65







Kunststoff-Unterteller
Cloche inférieure synthétique
«Caldoset»

625032308 26 cm   31.25



Cloche grau
Cloche gris
«blu'cloche»

4000482 Ø 24/26 cm   43.50

4000498 Ø 26/29,5 cm   44.65



Unterteil grau
Inférieure gris
«blu'cloche»

4000483 Ø 24/26 cm   43.50

4000501 Ø 26/29,5 cm   44.65



Kühl-Unterteil
Assiette frigorifique
«Variocool»

640330101 26 cm   45.00

blu'cloche

Die Clochensysteme der blu'line Serie sind perfekt für die Warmspeisenverteilung in Heimen, Spitälern und ähnlicher Einrichtungen geeignet. Der doppelwandige Aufbau und der PUR-Isolationsschaum garantieren, dass die Speisen auf den Tellern, Suppentassen und Eintopfschalen während des Transport heiß bleiben. Aus hochschlagzähem PP-C mit Silber Zeolith. Ober- und Unterteile sind auch separat erhältlich sowie auf- und ineinander stapelbar.

Les systèmes cloches de la série blu'line conviennent parfaitement à la distribution des repas chauds pour les homes, hôpitaux etc. La structure à doubles parois et la mousse isolante PUR garantissent que les aliments restent chauds durant le transport. En PP-C très résistant avec zeolith argent. Les parties supérieures et inférieures sont aussi livrables séparément et empilables les unes sur les autres.



625042309

Isolierteil für Glace und Dessert
Cloche pour glace et dessert
«CoolingCUP»

Ø 9,82 x H 8,65 cm   55.25

*passend für Emmi Senzazione Glace 100 ml und Emmi Suisse Yogourt 90 g
convient pour la glace Emmi Senzazione 100 ml et le Yogourt Emmi Suisse 90 g*



640332101

Suppentassen-Isolier-Oberteil grau
Cloche supérieure pour bol à soup gris
«Vario»

Ø 17 cm x H 4 cm   39.50



640334101

Suppentassen-Isolier-Unterteil grau
Cloche inférieure pour bol à soup gris
«Vario»

Ø 16 cm x H 7 cm   36.50



640331101

Suppentassen-Isolier-Oberteil hellblau
Cloche supérieure pour bol à soup bleu
«Vario»

Ø 17 cm x H 4 cm   39.50



640333101

Suppentassen-Isolier-Unterteil hellblau
Cloche inférieure pour bol à soup bleu
«Vario»

Ø 16 cm x H 7 cm   36.50



640371101

Suppentasse inox mit Porzellaneinsatz
Bol à potage po pour bol à soup
«Rezykliert»

40 cl / Ø 12,5 cm   39.95



640371102



Suppentasse inox mit Porzellaneinsatz
Bol à potage po pour bol à soup
«Reparatur»

40 cl / Ø 12,5 cm   28.20



8006.48120

Suppentasse, doppelwandig
Tasse à soupe, double-paroi

30 cl / Ø 11 x H 5,5 cm   44.65



8006.48121

Deckel, doppelwandig
Couvercle, double-paroi

Ø 11 x H 5,5 cm   29.35

Das Atelier, das Ihre Wünsche erfüllt

Individuelle Dekore fördern die positive Ausstrahlung eines Hauses. Wir dekorieren das von Ihnen gewählte Porzellan mit Markenzeichen, Emblemen, Hausfarben oder Slogans. Oder wir entwerfen es neu – nach Ihren Vorgaben.

L'atelier qui comble vos désirs

Un décor personnalisé souligne le rayonnement positif d'une maison. Nous décorons la porcelaine de votre choix avec vos logos, vos emblèmes, les couleurs de votre maison ou vos slogans. Ou nous en créons de nouveaux – selon vos données.



 **BAUSCHER**
GERMANY

special design

Ein Original, speziell entworfen für Ihr Haus.

Nicht nur in der Wirtschaft, auch in der Gastronomie spielt das Marketing eine wichtige Rolle. Ein durchgängig eingehaltenes Corporate Design gehört dazu. Das Porzellan leistet hier einen wichtigen Beitrag. Denn es ist Gebrauchsgegenstand und Imageträger zugleich. Präzise abgestimmt auf das jeweilige Erscheinungsbild entstehen Lösungen, die das Porzellan zum integrierten Bestandteil der Unternehmens-Identität machen.

Wir beraten Sie gerne...

Un original conçu spécialement pour votre établissement.

Comme dans tout autre secteur, le marketing joue également un rôle déterminant dans l'hôtellerie et la restauration. Un «corporate design» respecté à tous les niveaux en fait partie. La vaisselle apporte à cet égard une contribution importante. Car c'est à la fois un objet utilitaire et un support d'image. Grâce à des solutions parfaitement adaptées à votre image, votre vaisselle fait partie intégrante de l'identité de votre entreprise.

C'est avec plaisir que nous vous conseillons...



Immer griffbereit

Tassen mit ergonomischem Henkel greifen sich mit einem Dekor als Orientierungshilfe noch einfacher.

Toujours à portée de main

Des tasses avec anses ergonomiques qui se laissent saisir très simplement grâce au décor comme point de repère.



Besser essen

Eine kontrastreiche Pinselband-Dekoration sorgt für Orientierung auf dem Teller und macht die Speisenaufnahme sicherer.

Mieux manger

Une décoration contrastée crée des repères sur l'assiette et assure la prise des aliments.



Kindergerecht

Für die kleinen bieten wir farbenfrohe Motive, die für Abwechslung beim Klinikaufenthalt sorgen.

Pour les enfants

Nous offrons des motifs haut en couleurs qui permettent une diversion lors de séjours en clinique.

heart
& SOUL



perfect match



Teller flach coup
Assiette plate coupe
_cumin

23011215102	15 cm			9.30
23011221102	21 cm			13.25
23011227102	27 cm			22.60
23011230102	30 cm			31.80



Bowl
Bol
_cumin

23015710102	10 cm / 25 cl			9.95
23015714102	14 cm / 60 cl			13.25



Bowl
Bol
_cumin

23015719102	19 cm / 80 cl			19.85
23015723102	23 cm / 1,5 L			26.60



Teller tief coup
Assiette creuse coupe
_cumin

23011323102	23 cm			22.50
23011328102	28 cm			25.30



Espresso-Tasse
Tasse à espresso
_cumin

23015258102	8 cl			7.95
-------------	------	--	--	------



Espresso-Untertasse
Soutasse à espresso
_cumin

23016908102	12 cm			4.95
-------------	-------	--	--	------



Teller flach mit Stapelrand
Assiette plate à bord empilable
_cumin

23011821102	21 cm			23.95
23011827102	27 cm			29.80



Kaffee-Tasse
Tasse à café
_cumin

23015271102	21 cl			9.30
-------------	-------	--	--	------



Kaffee-Untertasse
Soutasse à café ronde
_cumin

23016921102	14 cm			5.95
-------------	-------	--	--	------



Schale nieder
Bol bas
_cumin

23011921102	21 cm			26.60
23011924102	24 cm			34.60



Platte oval coup
Plat ovale coup
_cumin

23012225102	25 x 19 cm			26.60
23012231102	31 x 24 cm			37.20
23012236102	36 x 28 cm			49.80



Kaffee-Tasse
Tasse à café
_cumin

23015284102	34 cl			10.60
-------------	-------	--	--	-------



Kaffee-Untertasse
Soutasse à café ronde
_cumin

23016934102	16 cm			6.50
-------------	-------	--	--	------



Schälchen
Coupelle
_cumin

23016108102	8 cm / 6 cl			6.60
-------------	-------------	--	--	------



Becher
Mug
_cumin

23015625102	25 cl			9.95
-------------	-------	--	--	------



Kantenschlagfest
Résistant aux chocs sur les bords



perfect match _breeze



Teller flach coup
Assiette plate coupe
_breeze

23011215100	15 cm			9.30
23011221100	21 cm			13.25
23011227100	27 cm			22.60
23011230100	30 cm			31.80



Bowl
Bol

23015710100	10 cm / 25 cl			9.95
23015714100	14 cm / 60 cl			13.25



Bowl
Bol

23015719100	19 cm / 80 cl			19.85
23015723100	23 cm / 1,5 L			26.60



Teller tief coup
Assiette creuse coupe
_breeze

23011323100	23 cm			22.50
23011328100	28 cm			25.30



Espresso-Tasse
Tasse à espresso

23015258100	8 cl			7.95
-------------	------	--	--	------



Teller flach mit Stapelrand
Assiette plate à bord empilable
_breeze

23011821100	21 cm			23.95
23011827100	27 cm			29.80



Espresso-Untertasse
Soutasse à espresso

23016908100	12 cm			4.95
-------------	-------	--	--	------



Schale nieder
Bol bas

23011921100	21 cm			26.60
23011924100	24 cm			34.60



Kaffee-Tasse
Tasse à café

23015271100	21 cl			9.30
-------------	-------	--	--	------



Platte oval coup
Plat ovale coup
_breeze

23012225100	25 x 19 cm			26.60
23012231100	31 x 24 cm			37.20
23012236100	36 x 28 cm			49.80



Kaffee-Untertasse
Soutasse à café ronde

23016921100	14 cm			5.95
-------------	-------	--	--	------



Schälchen
Coupelle
_breeze

23016108100	8 cm / 6 cl			6.60
-------------	-------------	--	--	------



Kaffee-Tasse
Tasse à café

23015284100	34 cl			10.60
-------------	-------	--	--	-------



Kaffee-Untertasse
Soutasse à café ronde

23016934100	16 cm			6.50
-------------	-------	--	--	------



Becher
Mug

23015625100	25 cl			9.95
-------------	-------	--	--	------



Kantenschlagfest
Résistant aux chocs sur les bords



Teller flach coup
Assiette plate coupe
_thyme

23011215104	15 cm			9.30
23011221104	21 cm			13.25
23011227104	27 cm			22.60
23011230104	30 cm			31.80



Teller tief coup
Assiette creuse coupe
_thyme

23011323104	23 cm			22.50
23011328104	28 cm			25.30



Teller flach mit Stapelrand
Assiette plate à bord empilable
_thyme

23011821104	21 cm			23.95
23011827104	27 cm			29.80



Schale nieder
Bol bas
_thyme

23011921104	21 cm			26.60
23011924104	24 cm			34.60

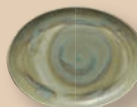

Platte oval coup
Plat ovale coup
_thyme

23012225104	25 x 19 cm			26.60
23012231104	31 x 24 cm			37.20
23012236104	36 x 28 cm			49.80



Schälchen
Coupelle
_thyme

23016108104	8 cm / 6 cl			6.60
-------------	-------------	--	--	------



Bowl
Bol
_thyme

23015710104	10 cm / 25 cl			9.95
23015714104	14 cm / 60 cl			13.25



Bowl
Bol
_thyme

23015719104	19 cm / 80 cl			19.85
23015723104	23 cm / 1,5 L			26.60



Espresso-Tasse
Tasse à espresso
_thyme

23015258104	8 cl			7.95
-------------	------	--	--	------



Espresso-Untertasse
Soutasse à espresso
_thyme

23016908104	12 cm			4.95
-------------	-------	--	--	------



Kaffee-Tasse
Tasse à café
_thyme

23015271104	21 cl			9.30
-------------	-------	--	--	------



Kaffee-Untertasse
Soutasse à café ronde
_thyme

23016921104	14 cm			5.95
-------------	-------	--	--	------



Kaffee-Tasse
Tasse à café
_thyme

23015284104	34 cl			10.60
-------------	-------	--	--	-------



Kaffee-Untertasse
Soutasse à café ronde
_thyme

23016934104	16 cm			6.50
-------------	-------	--	--	------



Becher
Mug
_thyme

23015625104	25 cl			9.95
-------------	-------	--	--	------



Kantenschlagfest
Résistant aux chocs sur les bords



perfect match _oyster



Teller flach coup
Assiette plate coupe
_oyster

23011215101	15 cm			9.30
23011221101	21 cm			13.25
23011227101	27 cm			22.60
23011230101	30 cm			31.80



Bowl
Bol

23015710101	10 cm / 25 cl			9.95
23015714101	14 cm / 60 cl			13.25

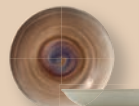

Teller tief coup
Assiette creuse coupe
_oyster

23011323101	23 cm			22.50
23011328101	28 cm			25.30



Bowl
Bol

23015719101	19 cm / 80 cl			19.85
23015723101	23 cm / 1,5 L			26.60



Espresso-Tasse
Tasse à espresso
_oyster

23015258101	8 cl			7.95
-------------	------	--	--	------



Teller flach mit Stapelrand
Assiette plate à bord empilable
_oyster

23011821101	21 cm			23.95
23011827101	27 cm			29.80



Espresso-Untertasse
Soutasse à espresso
_oyster

23016908101	12 cm			4.95
-------------	-------	--	--	------



Schale nieder
Bol bas
_oyster

23011921101	21 cm			26.60
23011924101	24 cm			34.60



Kaffee-Tasse
Tasse à café
_oyster

23015271101	21 cl			9.30
-------------	-------	--	--	------



Platte oval coup
Plat ovale coup
_oyster

23012225101	25 x 19 cm			26.60
23012231101	31 x 24 cm			37.20
23012236101	36 x 28 cm			49.80



Kaffee-Untertasse
Soutasse à café ronde
_oyster

23016921101	14 cm			5.95
-------------	-------	--	--	------



Kaffee-Tasse
Tasse à café
_oyster

23015284101	34 cl			10.60
-------------	-------	--	--	-------



Schälchen
Coupelle
_oyster

23016108101	8 cm / 6 cl			6.60
-------------	-------------	--	--	------



Kaffee-Untertasse
Soutasse à café ronde
_oyster

23016934101	16 cm			6.50
-------------	-------	--	--	------



Becher
Mug
_oyster

23015625101	25 cl			9.95
-------------	-------	--	--	------



Kantenschlagfest
Résistant aux chocs sur les bords



Teller flach coup
Assiette plate coupe
_avocado

23011215103	15 cm			9.30
23011221103	21 cm			13.25
23011227103	27 cm			22.60
23011230103	30 cm			31.80



Teller tief coup
Assiette creuse coupe
_avocado

23011323103	23 cm			22.50
23011328103	28 cm			25.30



Teller flach mit Stapelrand
Assiette plate à bord empilable
_avocado

23011821103	21 cm			23.95
23011827103	27 cm			29.80



Schale nieder
Bol bas
_avocado

23011921103	21 cm			26.60
23011924103	24 cm			34.60

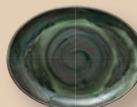

Platte oval coup
Plat ovale coup
_avocado

23012225103	25 x 19 cm			26.60
23012231103	31 x 24 cm			37.20
23012236103	36 x 28 cm			49.80



Schälchen
Coupelle
_avocado

23016108103	8 cm / 6 cl			6.60
-------------	-------------	--	--	------



Bowl
Bol
_avocado

23015710103	10 cm / 25 cl			9.95
23015714103	14 cm / 60 cl			13.25



Bowl
Bol
_avocado

23015719103	19 cm / 80 cl			19.85
23015723103	23 cm / 1,5 L			26.60



Espresso-Tasse
Tasse à espresso
_avocado

23015258103	8 cl			7.95
-------------	------	--	--	------



Espresso-Untertasse
Soutasse à espresso
_avocado

23016908103	12 cm			4.95
-------------	-------	--	--	------



Kaffee-Tasse
Tasse à café
_avocado

23015271103	21 cl			9.30
-------------	-------	--	--	------



Kaffee-Untertasse
Soutasse à café ronde
_avocado

23016921103	14 cm			5.95
-------------	-------	--	--	------



Kaffee-Tasse
Tasse à café
_avocado

23015284103	34 cl			10.60
-------------	-------	--	--	-------



Kaffee-Untertasse
Soutasse à café ronde
_avocado

23016934103	16 cm			6.50
-------------	-------	--	--	------



Becher
Mug
_avocado

23015625103	25 cl			9.95
-------------	-------	--	--	------



Kantenschlagfest
Résistant aux chocs sur les bords

⌘ JOLIE TABLE



calypso



Teller flach mit Rand
Assiette plate avec bord
«biscotti»

2086.10201	20 cm			9.30
2086.10101	24 cm			10.60
2086.10001	27 cm			13.30



Teller flach mit Rand
Assiette plate avec bord
«sepia»

2086.10202	20 cm			9.30
2086.10102	24 cm			10.60
2086.10002	27 cm			13.30



Teller tief
Assiette creuse
«biscotti»

2086.10301	Ø 23 cm x H 5 cm			13.30
------------	------------------	--	--	-------



Teller tief
Assiette creuse
«sepia»

2086.10302	Ø 23 cm x H 5 cm			13.30
------------	------------------	--	--	-------



Schale
Bol
«biscotti»

2086.10401	Ø 13 cm x H 6,6 cm			7.95
------------	--------------------	--	--	------



Schale
Bol
«sepia»

2086.10402	Ø 13 cm x H 6,6 cm			7.95
------------	--------------------	--	--	------



Becher
Gobelet
«biscotti»

2086.10501	25 cl / Ø 8 cm x H 10,2 cm			6.60
------------	----------------------------	--	--	------



Becher
Gobelet
«sepia»

2086.10502	25 cl / Ø 8 cm x H 10,2 cm			6.60
------------	----------------------------	--	--	------



DEGRENE
PARIS



collection L couture ivoire





Teller flach
Assiette plate

59239327210 24 cm   23.85





Gourmetteller tief
Assiette gourmet creuse

59239330210 28 cm   46.60
passend: «gourmet» Gourmetbol 12 cm
compatible: «gourmet» Bol gourmet 12 cm





Teller flach
Assiette plate

59239326210 28 cm   34.25
passend: «gourmet» Teller tief/Cocotte 18 cm
compatible: «gourmet» Grand assiette cocotte 18 cm





Gourmetteller tief
Assiette gourmet creuse

59239311210 30 cm   49.30
passend: «gourmet» Cocotte 14 cm
compatible: «gourmet» Cocotte 14 cm



Teller flach
Assiette plate

59239328210 32 cm   49.30
passend: «gourmet» Teller tief/Cocotte 22 cm
compatible: «gourmet» Grand assiette cocotte 22 cm



Brotteller flach
Assiette à pain plate

59239329210 14 cm   17.30

Perfekt in Kombination mit der Serie «gourmet»
Parfait en combinaison avec la série «gourmet»





DEGRENE
PARIS



collection L fragment



Espressotasse
Tasse à espresso

59227828210 10 cl 15.85



Kaffee-Tasse
Tasse à café

59227829210 25 cl 20.35



Espresso-Untertasse
Soutasse espresso

59227849210 Ø 12,6 cm 19.95



Kaffee-Untertasse
Soutasse à café

59227850210 Ø 15,8 cm 21.70



Teller flach
Assiette plate

59227845210 24 cm 23.85



Teller flach
Assiette plate

59227844210 28 cm 34.25

passend: «gourmet» Teller tief/Cocotte 18 cm

compatible: «gourmet» Grand assiette cocotte 18 cm



Teller flach
Assiette plate

59227843210 32 cm 49.30

passend: «gourmet» Teller tief/Cocotte 22 cm

compatible: «gourmet» Grand assiette cocotte 22 cm



Brotteller flach
Assiette à pain plate

59227846210 14 cm 17.30



Gourmetteller tief
Assiette gourmet creuse

59227848210 28 cm 49.30

passend: «gourmet» Gourmetbol 12 cm

compatible: «gourmet» Bol gourmet 12 cm



Gourmetteller tief
Assiette gourmet creuse

59227847210 30 cm 49.30

passend: «gourmet» Cocotte 14 cm

compatible: «gourmet» Cocotte 14 cm



Cloche Inox
Cloche Inox

59182301132 14,8 cm 28.20

59182614132 24,0 cm 49.35



Cloche Glas mit Öffnung
Cloche verre avec ouverture

59204043132 16 cm 28.20



Porzellan-Verschluss zu Cloche Glas
Bouchon porcelaine pour cloche verre

59206504132 5,2 cm 4.65

Perfekt in Kombination mit der Serie «gourmet»
Parfait en combinaison avec la série «gourmet»







DEGRENNE
PARIS



gourmet





Teller tief / Cocotte
Grand assiette cocotte

59235064250 18 cm / 70 cl   29.30
59234342250 22 cm / 100 cl   29.55







Gourmetbol
Bol gourmet

59234340250 16 cm / 100 cl   25.30



Teller tief / Cocotte
Grand assiette cocotte
«carbone»

59235066250 18 cm / 70 cl   34.90
59234336250 22 cm / 100 cl   37.95







Gourmetbol
Bol gourmet
«carbone»

59234334250 16 cm / 100 cl   29.55





Teller gross cocotte
Grand assiette cocotte
«blue»

59235063250 18 cm / 70 cl   43.95
59234339250 22 cm / 100 cl   46.60



Gourmetbol
Bol gourmet
«blue»

59234337250 16 cm / 100 cl   37.95





Cocotte
Cocotte

59234341250 17,5 cm / 140 cl   34.25





Cocotte
Cocotte
«carbone»

59234335250 17,5 cm / 140 cl   37.95





Cocotte
Cocotte
«blue»



59234338250 17,5 cm / 140 cl   49.95



gourmet

Cocotte
Cocotte59209383250 14 cm / 50 cl   13.30Teller/Deckel zu Cocotte
Assiette/Couvercle pour Cocotte59209384250 12,5 cm   10.60Cocotte
Cocotte«blue stone»
14 cm / 50 cl59230972250   15.85Teller/Deckel zu Cocotte
Assiette/Couvercle pour Cocotte
«blue stone»59230973250   12.25Cocotte
Cocotte
«carbone»59204041250 14 cm / 50 cl   15.85Teller/Deckel zu Cocotte
Assiette/Couvercle pour Cocotte
«carbone»59204042250 12,5 cm   11.45Cocotte
Cocotte«brown basalt»
14 cm / 50 cl59230944250   15.85Teller/Deckel zu Cocotte
Assiette/Couvercle pour Cocotte
«brown basalt»59230945250   12.25Cocotte
Cocotte
«blue»59230821250 14 cm / 50 cl   17.30Teller/Deckel zu Cocotte
Assiette/Couvercle pour Cocotte
«blue»59230820250 12,5 cm   11.95Cocotte
Cocotte
«green clay»

14 cm / 50 cl

59230958250   15.85Teller/Deckel zu Cocotte
Assiette/Couvercle pour Cocotte
«green clay»59230959250   12.25Cocotte
Cocotte
«beige dune»59230927250 14 cm / 50 cl   15.85Teller/Deckel zu Cocotte
Assiette/Couvercle pour Cocotte
«beige dune»59230928250 12,5 cm   11.45Cocotte
Cocotte
«rose nude»

14 cm / 50 cl

5924377250   15.85Teller/Deckel zu Cocotte
Assiette/Couvercle pour Cocotte
«rose nude»59243780250 12,5 cm   11.45



Gourmetbol
Bol gourmet

59186849250 12 cm / 30 cl   11.45



Mini-Gourmetbol
Mini bol gourmet

59211891250 7,3 cm / 7 cl   6.35



Gourmetbol
Bol gourmet
«carbone»

59234209250 12 cm / 30 cl   13.30



Mini-Gourmetbol
Mini bol gourmet
«carbone»

59234208250 7,3 cm / 7 cl   9.55



Gourmetbol
Bol gourmet
«blue»

59230822250 12 cm / 30 cl   15.05





Mini-Gourmetbol
Mini bol gourmet
«blue»

59230823250 7,3 cm / 7 cl   9.55





Gourmetbol
Bol gourmet
«beige dune»

59230926250 12 cm / 30 cl   13.30



Mini-Gourmetbol
Mini bol gourmet
«beige dune»

59230925250 7,3 cm / 7 cl   9.55



Gourmetbol
Bol gourmet
«blue stone»

59230971250 12 cm / 30 cl   13.30





Mini-Gourmetbol
Mini bol gourmet
«blue stone»

59230970250 7,3 cm / 7 cl   9.55





Gourmetbol
Bol gourmet
«brown basalt»

59230943250 12 cm / 30 cl   13.30



Mini-Gourmetbol
Mini bol gourmet
«brown basalt»

59230942250 7,3 cm / 7 cl   9.55



Gourmetbol
Bol gourmet
«green clay»

59230957250 12 cm / 30 cl   13.30



Mini-Gourmetbol
Mini bol gourmet
«green clay»

59230956250 7,3 cm / 7 cl   9.55



Gourmetbol
Bol gourmet
«rose nude»

59243786250 12 cm / 30 cl   13.30



Mini-Gourmetbol
Mini bol gourmet
«rose nude»

59243783250 7,3 cm / 7 cl   9.55



DEGRENE
PARIS



brume



Teller flach
Assiette plate
Rosa
20 cm

59241268240

24.75



Teller flach
Assiette plate
Taupe
20 cm

59241272240

24.75



Teller flach
Assiette plate
Rosa
26 cm

59241267240

29.30



Teller flach
Assiette plate
Taupe
26 cm

59241271240

29.30



Schale
Bol
Rosa

59241269240

88 cl / 20 cm

26.60



Schale
Bol
Taupe

59241273240

88 cl / 20 cm

26.60



Schälchen
Bol
Rosa

59241270240

23 cl / 12,5 cm

18.60



Schälchen
Bol
Taupe

59241274240

23 cl / 12,5 cm

18.60



Teller flach
Assiette plate
Sand
20 cm

59241276240

24.75



Teller flach
Assiette plate
Lait
20 cm

59244751240

24.75



Teller flach
Assiette plate
Sand
26 cm

59241275240

29.30



Teller flach
Assiette plate
Lait
26 cm

59244749240

29.30



Schale
Bol
Sand

59241277240

88 cl / 20 cm

26.60



Schale
Bol
Lait

59244753240

88 cl / 20 cm

26.60



Schälchen
Bol
Sand

59241278240

23 cl / 12,5 cm

18.60



Schälchen
Bol
Lait

59244755240

23 cl / 12,5 cm

18.60



DEGRENNE
PARIS



bahia



59241835220

Backform rechteckig
Plat à gratin rectangulaire
Mondstein/Pierre de lune

31,8 x 25 x H 7,4 cm



62.30



59237595220

Backform rechteckig
Plat à gratin rectangulaire
Steinblau/Bleu de roche

31,8 x 25 x H 7,4 cm



62.30



59241834220

Backform rechteckig
Plat à gratin rectangulaire
Mondstein/Pierre de lune

22,8 x 16,2 cm x H 5,4 cm



35.15



59237594220

Backform rechteckig
Plat à gratin rectangulaire
Steinblau/Bleu de roche

22,8 x 16,2 cm x H 5,4 cm



35.15



59241833220

Backform rechteckig
Plat à gratin rectangulaire
Mondstein/Pierre de lune

15,5 x 10,7 x H 4,4 cm



26.55



59237593220

Backform rechteckig
Plat à gratin rectangulaire
Steinblau/Bleu de roche

15,5 x 10,7 x H 4,4 cm



26.55

Backofenfest
(Temperatur-Delta 180°C)

Résistant au four
(Delta de température 180°C)



matcha



Schale hellgrün
Bol vert clair

640-30408

27 cl, H 5,8 cm, Ø 11,3 cm

9.30



Schale sandfarben
Bol sable

640-30403

27 cl, H 5,8 cm, Ø 11,3 cm

9.30



Schale türkis
Bol turquoise

640-30407

27 cl, H 5,8 cm, Ø 11,3 cm

9.30



Schale rosa
Bol rose

640-30411

27 cl, H 5,8 cm, Ø 11,3 cm

9.30



Schale grau
Bol gris

640-30402

27 cl, H 5,8 cm, Ø 11,3 cm

9.30



costaverde
porcelanas



the summit



Platte rund
Plat rond

50500030051 Ø 30 cm / H 5 cm   59.80





Schüssel
Bol

50500350051 Ø 18 cm / H 7,5 cm   39.75





Platte oval
Plat ovale

50500040051 26 x 19 cm / H 7 cm   52.80



Giesser
Petite cruche

50501500051 30 cl / Ø 8,5 cm / H 8 cm   26.40





Platte quadratisch
Plat carré

50500150051 26 x 26 cm / Ø 25 cm / H 3 cm   66.40



Podium rund
Podium rond

50518330051 Ø 10 cm / H 9 cm   29.20





Platte quadratisch
Plat carré

50500300051 20 x 20 cm / Ø 16 cm / H 3 cm   59.80



Podium quadratisch
Podium carré

50518340051 10 x 10 cm / Ø 7,5 cm / H 9 cm   39.75



Platte eckig
Plat rectangulaire

50500160051 26 x 18 cm   46.40



Platte eckig
Plat rectangulaire

50500170051 22 x 18 cm   43.80



hering berlin

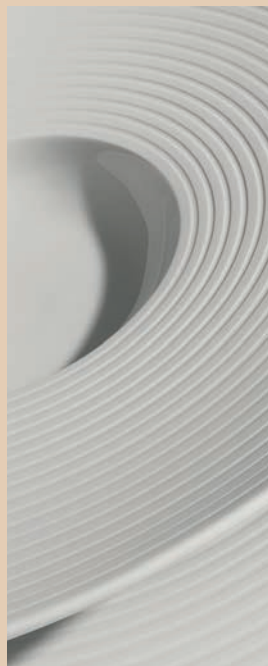
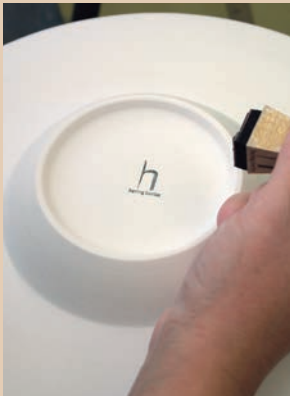

Vollendet sinnliche Porzellankunst

Hering Berlin ist einzigartig durch die Handschrift von Stefanie Hering. Ihre klare moderne Formensprache verleiht dem Porzellan von Hering Berlin sein Gesicht.

Die sinnliche Anmutung von mattem Biskuitporzellan und das raffinierte reduzierte Spiel mit zarter Transparenz und Struktur sind Markenzeichen der Manufaktur. Stefanie Herings Credo ist: «Sinnvolles sinnlich gestalten».

Biskuit ist Porzellan unglasiert, pur und unverfälscht. In sorgfältiger und kompromissloser Handarbeit wird der Charakter des Materials fühlbar gemacht: samtweiche Oberfläche, Finesse des Durchbruches und Prägnanz der Struktur.

Raffinierte Teller- und Schalenformen lassen sich frei miteinander kombinieren und erlauben einzigartige Inszenierungen. Für die Tafelservices stehen zudem wertvolle Dekore zur Auswahl, von weissen Reliefs über zarte Kobalt-Handzeichnungen bis zu edlen Scherenschnitten in Silber, Gold und Platin.

L'art parfait de la porcelaine

La porcelaine Hering Berlin est unique grâce à la griffe de Stefanie Hering. Ses formes épurées et modernes créent véritablement le design de la porcelaine Hering Berlin.

La porcelaine biscuit matte et le jeu raffiné d'une délicate transparence avec une fine structure en font les caractéristiques de cette manufacture.

La porcelaine biscuit est pure, non émaillée et non falsifiée. Un travail manuel soigné et intransigent met en valeur la sensibilité du matériau: des surfaces veloutées, la finesse et la netteté de la structure.

Les formes élégantes des assiettes et des coupes se combinent de façon idéale et permettent des présentations uniques. De nombreux décors sont à disposition pour les services de table, des reliefs blancs aux dessins faits main cobalt jusqu'aux décors haut de gamme en argent or ou platine.



hering berlin

velvet

Bisquitporzellan, fein geschliffen,
spülmaschinenfest und mikrowellengeeignet.

Porcelaine biscuit, finement poli,
convient au lave-vaisselle et micro-onde



pulse

Bisquitporzellan, von Hand gemalte und ausgewaschene Oberfläche,
spülmaschinenfest und mikrowellengeeignet.

Porcelaine biscuit, peinte main, surface érodée,
convient au lave-vaisselle et micro-onde



cielo

Bisquitporzellan, von Hand perforiert,
spülmaschinenfest und mikrowellengeeignet.

Porcelaine biscuit, perforée à la main,
convient au lave-vaisselle et micro-onde



Tischkultur, Luxus, pure Schönheit.

Besuchen Sie unseren Showroom und entdecken Sie höchste Tischkultur, erlesene Objekte und kostbare Unikate. Kontaktieren Sie Ihren Aussendienstmitarbeiter oder den Innendienst für einen Termin.

Art de la table, luxe, pure beauté.

Nous vous invitons à visiter notre showroom et à découvrir l'art de table à son plus haut niveau, des objets exclusifs sélectionnés pour vous et des pièces uniques et précieuses. Veuillez contacter nos représentants ou le service interne pour fixer un rendez-vous.



Brotteller
Assiette pain
Ø 18 cm x H 2 cm



101_010_00	velvet	66.40
101_030_00	pulse	99.80

Teller flach
Assiette plate
Ø 23,2 cm x H 2 cm



102_010_00	velvet	86.60
102_030_00	pulse	131.70

Teller flach
Assiette plate
Ø 29 cm x H 2,8 cm



103_010_00	velvet	99.80
103_030_00	pulse	159.70

Teller flach
Assiette plate
Ø 32 cm x H 2 cm



104_010_00	velvet	119.70
104_030_00	pulse	186.50



Plattteller/Platte
Assiette présentation/Plat
Ø 37 cm x H 2,5 cm



106_010_00	velvet	173.15
106_030_00	pulse	293.30

Teller schmale Fahne
Assiette à bord étroit
Ø 32,5 cm x H 2 cm



107_010_00	velvet	119.70
107_030_00	pulse	186.50

Coupeteller
Assiette coupe
Ø 20,5 cm x H 3,3 cm



108_010_00	velvet	71.30
108_030_00	pulse	111.95

Coupeteller
Assiette coupe
Ø 31 cm x H 4,5 cm



109_010_00	velvet	119.70
109_030_00	pulse	186.50
109_020_00	cielo	359.80



Brotteller
Assiette pain
Ø 16 cm x H 2,2 cm



116_010_00	velvet	66.40
116_030_00	pulse	95.95

Teller mit Spiegel, vertieft
Assiette mi-creuse
Ø 26 cm x H 3 cm



115_010_00	velvet	93.05
115_030_00	pulse	149.80

Teller mit Spiegel, vertieft
Assiette mi-creuse
Ø 32 cm x H 3 cm



105_010_00	velvet	111.95
105_030_00	pulse	186.50

Teller tief
Assiette creuse
Ø 30 cm x H 5,5 cm / 38 cl



111_010_00	velvet	119.70
111_030_00	pulse	186.50



hering berlin



Teller tief
Assiette creuse
Ø 25 cm x H 6 cm / 25 cl



110_010_00	velvet	99.80
110_030_00	pulse	131.75



Teller oval
Assiette ovale
Ø 33,5 x 17,6 cm x H 2,4 cm



113_010_00	velvet	173.15
113_030_00	pulse	226.40



Löffel
Cuillère
12 cm x H 3,7 cm



503_010_00	velvet	66.40
------------	--------	-------



Teller/Podest
Assiette
Ø 16,8 cm x H 4,1 cm



118_010_00	velvet	111.95
118_030_00	pulse	198.80



Teller/Podest
Assiette
Ø 12 cm x H 4,1 cm



119_010_00	velvet	99.80
119_030_00	pulse	159.70



Gourmetschale
Bol gourmet
Ø 16 cm x H 4 cm / 5 cl



208_010_00	velvet	75.95
208_030_00	pulse	89.30



Gourmetschale
Bol gourmet
Ø 19 cm x H 6 cm / 15 cl



209_010_00	velvet	74.60
209_030_00	pulse	119.70



Gourmetteller
Assiette gourmet
Passend zu 201 | Compatible avec 201
Ø 15 cm x H 3,5 cm



204_010_00	velvet	69.30
204_030_00	pulse	93.05
204_020_00	cielo	173.15



Gourmetteller
Assiette gourmet
Passend zu 202 | Compatible avec 202
Ø 18,5 cm x H 3,5 cm



205_010_00	velvet	79.70
205_030_00	pulse	110.60
205_020_00	cielo	265.20



Gourmetteller
Assiette gourmet
Passend zu 203 | Compatible avec 203
Ø 22 cm x H 4,5 cm / 6 cl



206_010_00	velvet	79.70
206_030_00	pulse	119.70
206_020_00	cielo	319.70







Gourmetteller
Assiette gourmet
Ø 30 cm x H 6 cm / 15 cl







207_010_00	velvet	119.70
207_030_00	pulse	186.50
207_020_00	cielo	398.80



**Schale
Bol**
Ø 7,5 cm x H 6 cm / 7 cl
 

**Schale
Bol**
Ø 11 cm x H 7,5 cm / 20 cl
 

**Schale
Bol**
Ø 13,5 cm x H 8,5 cm / 40 cl
 

**Schale
Bowl**
Ø 10,5 cm x H 3,7 cm
 



201_010_00	velvet	45.20
201_030_00	pulse	62.60



202_010_00	velvet	55.70
202_030_00	pulse	75.95



203_010_00	velvet	59.90
203_030_00	pulse	93.05



221_010_00	velvet	62.60
221_030_00	pulse	89.30



**Fusschale tief
Coupe à pied haute**
Ø 11,5 cm x H 13 cm / 23 cl
 

**Fusschale flach
Coupe à pied haute**
Ø 12,5 cm x H 13 cm / 13 cl
 

**Fusschale
Coupe à pied haute**
Ø 19,5 cm x H 15,5 cm
 

**Schale
Coupe**
Ø 10 cm x H 5,4 cm / 16 cl
 



528_010_00	velvet	119.70
528_030_00	pulse	186.50



529_010_00	velvet	119.70
529_030_00	pulse	186.50



530_010_00	velvet	198.80
530_030_00	pulse	293.30



212_010_00	velvet	39.70
212_030_00	pulse	66.40



**Schale
Coupe**
Ø 20 cm x H 5,8 cm / 50 cl
 

**Speisehaube
Cloche**
Ø 18,4 cm x H 16 cm
 

**Speisehaube
Cloche**
Ø 10,7 cm x H 9,5 cm
 

**Gewürzschälchen
Bol herbes**
Ø 7 cm x H 3,7 cm / 3 cl
 

213_010_00	velvet	95.95
213_030_00	pulse	131.75

512_010_00	velvet	198.80
512_030_00	pulse	239.70

538_010_00	velvet	119.70
538_030_00	pulse	159.70

223_010_00	velvet	34.60
223_030_00	pulse	53.05



hering berlin

**Schale
Bol**

Ø 12,5 cm x H 7,2 cm / 40 cl



227_010_00	velvet	69.30
227_030_00	pulse	93.05

**Schale
Bol**

Ø 21 cm x H 13,2 cm / 230 cl



226_010_00	velvet	198.80
226_030_00	pulse	386.40

**Schale
Bol**

Ø 21 cm x H 7 cm / 135 cl



224_010_00	velvet	186.50
224_030_00	pulse	265.20
224_020_00	cielo	319.70

**Schale
Bol**

Ø 27,5 cm x H 9 cm / 180 cl



219_010_00	velvet	265.20
219_030_00	pulse	386.40
219_020_00	cielo	439.70

**Espressotasse
Tasse à espresso**Passend zu 311 | Compatible avec 311
Ø 7 cm x H 5,8 cm / 5 cl

307_000_00	fully glazed	53.05
------------	--------------	-------

**Kaffeetasse
Tasse à café**Passend zu 312 | Compatible avec 312
Ø 11 cm x H 8 cm / 17 cl

308_000_00	glazed	86.60
------------	--------	-------

**Becher/Tasse
Gobelet/Tasse seule**Passend zu 320 | Compatible avec 320
Ø 7 cm x H 7,7 cm / 10 cl

301_010_00	velvet	39.70
301_030_00	pulse	66.40

**Becher/Tasse
Gobelet/Tasse seule**

Ø 8,2 cm x H 8,2 cm / 22 cl



303_010_00	velvet	33.30
303_030_00	pulse	61.30

**Becher/Tasse
Gobelet/Tasse seule**Passend zu 312 | Compatible avec 312
Ø 8,4 cm x H 11,6 cm / 22 cl

302_010_00	velvet	53.05
302_030_00	pulse	75.95

**Untertasse
Soutasse**

Ø 13 cm x H 3 cm



311_010_00	velvet	47.95
311_030_00	pulse	69.30
311_020_00	cielo	131.75

**Untertasse
Soutasse**

Ø 16 cm x H 2,1 cm



312_010_00	velvet	57.30
312_030_00	pulse	93.05

**Untertasse
Soutasse**

Ø 13,5 cm



320_010_00	velvet	53.05
320_030_00	pulse	75.95



**Spezial
Special**

Passend zu 312 | Compatible avec 312
Ø 11,5 cm x H 10,5 cm



501_010_00	velvet	99.80
501_030_00	pulse	149.80

**Teekanne
Théière**

Ø 14 cm x H 20 cm / 80 cl



401_010_00	velvet	319.75
401_030_00	pulse	332.95

**Teekanne
Théière**

Ø 17 cm x H 19,3 cm / 160 cl



402_010_00	velvet	332.95
402_030_00	pulse	359.80

**Portionskanne für Kaffee/Tee
Théière/Cafetière**

Ø 11,5 cm x H 10 cm / 50 cl



414_010_00	velvet	131.75
414_030_00	pulse	186.50



**Krug
Cruche**

Ø 10,2 cm x H 15,5 cm / 85 cl



411_010_00	velvet	173.15
411_030_00	pulse	239.70

**Krug
Cruche**

Ø 6,3 cm x H 9,6 cm / 18,5 cl



412_030_00	pulse	131.75
------------	-------	--------

**Giesser ohne Henkel
Cremier sans anse**

Ø 8 cm x H 15,5 cm / 22 cl



405_010_00	velvet	74.60
405_030_00	pulse	111.95

**Giesser ohne Henkel
Cremier sans anse**

Ø 8 cm x H 8 cm / 10 cl



410_010_00	velvet	75.95
410_030_00	pulse	93.05



**Giesser ohne Henkel
Cremier sans anse**

Ø 6,3 cm x H 9,6 cm / 18,5 cl



417_010_00	velvet	74.60
417_030_00	pulse	115.95

**Giesser ohne Henkel
Cremier sans anse**

Ø 4,5 cm x H 6,5 cm / 5,5 cl



418_010_00	velvet	71.30
418_030_00	pulse	93.05

**Zuckerdose mit Deckel
Sucrier avec couvercle**

Ø 11,5 cm x H 7,5 cm / 25 cl



531_010_00	velvet	86.60
531_030_00	pulse	99.80



hering berlin

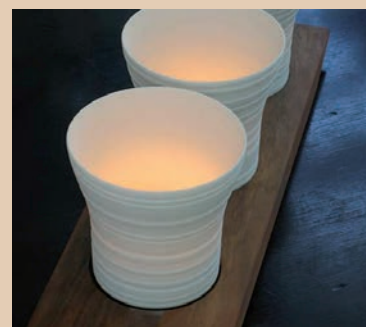

Flasche für Essig/Öl/Sojasauce
Bouteille pour huile/vinaigre
Ø 9 cm x H 16 cm / 27 cl



407_010_00	velvet	131.70
407_030_00	pulse	173.15



Amuse Bouche/Zuckerbar
Amuse bouche
21,2 x 9 cm



520_010_85	velvet	131.75
520_030_85	pulse	198.80



Amuse Bouche/Zuckerbar
Amuse bouche
30 x 9 cm



521_010_86	velvet	186.50
521_030_86	pulse	265.20



Menage
Ménagère
25,5 x 11,5 cm x H 13 cm



522_010_87	velvet	265.20
522_030_87	pulse	319.75



Set für Antipasti, Zucker
Set antipasti
25 x 11 cm



517_010_81	velvet	149.80
517_030_81	pulse	198.80



Menage
Ménagère
23,2 x 11 cm



518_010_82	velvet	198.80
518_030_82	pulse	265.20



Windlichter, 3er-Set
Set de 3 lanternes de table
30 x 9 cm



519_010_83	velvet	173.15
519_030_83	pulse	265.20



Menage
Ménagère
30 x 9 cm



519_010_84	velvet	265.20
519_030_84	pulse	359.80



Gewürzset
Set herbes
18,1 x 8 cm x H 4,5 cm



524_010_88	velvet	131.75
524_030_88	pulse	186.50



Gewürzset
Set herbes
25,8 x 8 cm x H 4,5 cm



525_010_89	velvet	173.15
525_030_89	pulse	239.70



Schale mit Holzdeckel
Bol avec couvercle bois
Ø 10 cm x H 5,4 cm / 16 cl



505_010_00	velvet	69.30
505_030_00	pulse	95.95



Schale mit Holzdeckel
Bol avec couvercle bois
Ø 8,2 cm x H 9,2 cm



507_010_00	velvet	66.40
507_030_00	pulse	93.05



dekore/décors

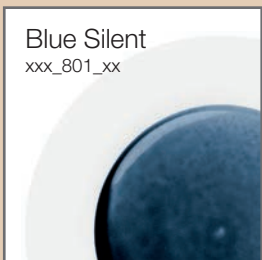
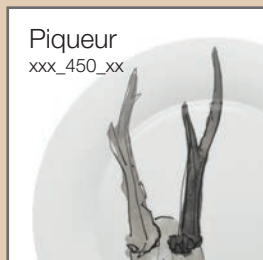



appetizer

Unbeschränkte Möglichkeiten, kulinarische Genüsse immer wieder neu zu präsentieren.

Possibilités illimitées afin de mettre vos plats cuisinés en évidence.



Schälchen quadratisch flach
Coupelle carrée plate

8024.16004 9,4 x 9,4 x H 1,7 cm   4.90



Schälchen tief
Coupelle creuse

8024.16013 10 cl / Ø 8,5 x H 4,5 cm   4.90





Schälchen rechteckig flach
Coupelle rectangulaire plate

8024.16003 14,5 x 7 x H 2,3 cm   4.90



Löffelschale
Coupe

8024.16011 Ø 10,6 x H 2,8 cm   4.90





Schale geschwungen
Coupelle spirit

8024.16009 Ø 14,4 x H 3 cm   4.90



Schälchen tief
Coupelle creuse

8024.16014 6,5 cl / Ø 9,5 x H 4,5 cm   4.90





Schälchen tief
Coupelle creuse

8024.16005 8,8 x 8,8 x H 4,8 cm   4.90





Naturschieferplatte, 1 Vertiefung
Plat ardoise, 1 approfondissement
Vertiefung/Evidement: Ø 5,9 cm 

8582.00986 25 x 12 cm   7.95





Schälchen tief
Coupelle creuse

8024.16008 12 cl / Ø 10,2 cm x H 4 cm   4.90



Naturschieferplatte, 2 Vertiefungen
Plat ardoise, 2 approfondissements
Vertiefung/Evidement: Ø 6 cm 

8582.00971 15 x 8 cm   4.65





Schälchen tief
Coupelle creuse

8024.16006 15 cl / Ø 9,6 x H 6 cm   4.90





Naturschieferplatte, 3 Vertiefungen
Plat ardoise, 3 approfondissements
Vertiefung/Evidement: Ø 5,9 cm 

8582.00987 28 x 10 cm   10.80



Schälchen tief
Coupelle creuse

8024.16007 6 cl / Ø 10 x H 4 cm   4.90



appetizer



Appetizergabel
Fourchette appetizer
«Nordic»

0956023200

14,2 cm



1.05



Schälchen
Coupelle
«Bubble»

715730000

5 cl / Ø 4,4 x H 5,4 cm



2.95



Appetizergabel
Fourchette appetizer

0966023200

11,4 cm



1.05



Becher
Gobelet
«Kube»

715733000

5 cl / Ø 4,4 x H 5,4 cm



3.45



Appetizergabel
Fourchette appetizer
«Zazu»

0967023100

11,2 cm



1.15



Becher
Gobelet
«Kube»

715732000

10 cl / Ø 5,8 x H 6,8 cm



4.65



Appetizergabel
Fourchette appetizer
«Zazu long»

0967024100

15 cm



1.95



Becher
Gobelet
«Fluted Lined»

711009000

5,9 cl / Ø 5,5 x H 7,5 cm



1.95



Appetizergabel
Fourchette appetizer
«Baguette»

0120023100

13,1 cm



1.70



Becher
Gobelet
«Fluted Whisky»

711041000

2,6 cl / Ø 4,9 x H 5,7 cm



1.95



Göffel (mini)
Fouillère (mini)

155996200

14,0 cm / Ø 2,7 mm



2.65



Becher
Gobelet
«Pressed Whisky»

711031000

4,4 cl / Ø 5,5 x H 7,0 cm



2.50





**Becher
Gobelet
«Bistro»**

7080.58220 13 cl / Ø 6,2 x H 6 cm   3.30





**Glas
Verre
«Granity»**

1500.43006 4,5 cl / Ø 5 x H 5,7 cm   12 1.30





**Becher
Gobelet
«Bodega»**

7080.58230 11 cl / Ø 6,8 x H 4,7 cm   3.30





**Glas
Verre
«Shetland»**

8004.12099 15 cl / Ø 7 x H 9 cm   6 2.25





**Becher
Gobelet
«Cucina»**

7080.58240 13 cl / Ø 7 x H 6,3 cm   3.30



**Glas
Verre
«Shetland»**

8004.12100 25 cl / Ø 9 x H 8,8 cm   6 2.50





**Becher
Gobelet
«Cube»**

7081.70110 14 cl / Ø 5,6 x H 6 cm   3.50



**Glas
Verre
«Islande»**

8004.09411 6 cl / Ø 3,8 x H 10,5 cm   12 1.30



**Becher
Gobelet
«Cylinder»**

7081.70120 15 cl / Ø 6,2 x H 6 cm   3.50





**Glas
Verre
«Eskale»**

1500.67005 9 cl / Ø 6 x H 6,5 cm   24 2.25



**Becher
Gobelet
«Triangle»**

7081.70130 15 cl / H 6 cm   3.50





**Glas
Verre
«Eskale»**

1500.67010 18 cl / Ø 7,7 x H 7,8 cm   6 2.65



**Becher
Gobelet
«Oval»**

7081.70140 15 cl / 5,2 x 7,2 x H 6 cm   3.50



**Glas
Verre
«Baril»**

1400.02011 16 cl / Ø 5,8 x H 8 cm   6 1.55



**Glas
Verre
«Alissa»**



7080.50000 9 cl   12 3.30



appetizer





Mini-Sturzglas ohne Deckel, 12er Set
Bocal droit sans couvercle, Set à 12
«Weck»

8582.82359 35 ml / Ø 40 mm x H 37 mm   16.20/Set



Sturzglas inkl. Deckel
Bocal droit incl. couvercle
«Weck»

8500.00021 165 ml / Ø 80 x H 47 mm   2.65





Mini-Sturzglas ohne Deckel, 12er Set
Bocal droit sans couvercle, Set à 12
«Weck»

8582.82370 80 ml / Ø 60 x H 55 mm   19.95/Set





Sturzglas inkl. Deckel
Bocal droit incl. couvercle
«Weck»

8500.00022 200 ml / Ø 80 x H 56 mm   2.90





Mini-Sturzglas ohne Deckel, 12er Set
Bocal droit sans couvercle, Set à 12
«Weck»

8582.82371 160 ml / Ø 60 x H 80 mm   21.50/Set



Sturzglas inkl. Deckel
Bocal droit incl. couvercle
«Weck»

8500.00023 290 ml / Ø 100 x H 55 mm   3.15





Mini-Sturzglas inkl. Deckel
Bocal droit incl. couvercle
«Weck»

8500.00035 35 ml / Ø 40 mm x H 37 mm   1.85



Sturzglas inkl. Deckel
Bocal droit incl. couvercle
«Weck»

8500.00024 290 ml / Ø 80 x H 87 mm   3.15





Mini-Sturzglas inkl. Deckel
Bocal droit incl. couvercle
«Weck»

8500.00005 50 ml / Ø 60 mm x H 37 mm   1.95



Sturzglas inkl. Deckel
Bocal droit incl. couvercle
«Weck»

8500.00025 370 ml / Ø 100 x H 69 mm   3.45





Mini-Sturzglas inkl. Deckel
Bocal droit incl. couvercle
«Weck»

8582.82310 80 ml / Ø 60 x H 55 mm   2.50



Sturzglas inkl. Deckel
Bocal droit incl. couvercle
«Weck»

8500.00050 580 ml / Ø 100 x H 107 mm   3.70





Mini-Sturzglas inkl. Deckel
Bocal droit incl. couvercle
«Weck»

8582.82312 140 ml / Ø 60 x H 69 mm   2.60



Sturzglas inkl. Deckel
Bocal droit incl. couvercle
«Weck»

8500.00075 850 ml / Ø 100 x H 147 mm   3.85



Mini-Sturzglas inkl. Deckel
Bocal droit incl. couvercle
«Weck»

8582.82314 160 ml / Ø 60 x H 80 mm   2.65



Mini-Tulpenglas inkl. Deckel
Bocal tulipe incl. couvercle
«Weck»

8500.00006 75 ml / Ø 40 x H 55 mm   2.25



Gugelhupfglas inkl. Deckel
Verre Gugelhupf incl. couvercle
«Weck»

8500.00219 80 ml / Ø 60 x H 54,5 mm   2.65





Mini-Tulpenglas inkl. Deckel
Bocal tulipe incl. couvercle
«Weck»

8582.82316 220 ml / Ø 60 x H 80 mm   2.90





Gugelhupfglas inkl. Deckel
Verre Gugelhupf incl. couvercle
«Weck»

8500.00220 165 ml / Ø 80 x H 55 mm   2.90



Tulpenglas inkl. Deckel
Bocal tulipe incl. couvercle
«Weck»

8500.00145 370 ml / Ø 80 x H 86 mm   3.45





Gugelhupfglas inkl. Deckel
Verre Gugelhupf incl. couvercle
«Weck»

8500.00221 280 ml / Ø 100 x H 60 mm   3.85





Tulpenglas inkl. Deckel
Bocal tulipe incl. couvercle
«Weck»

8500.00150 580 ml / Ø 100 x H 85 mm   3.70





Schmuckglas inkl. Deckel
Bocal fêtes incl. couvercle
«Weck»

8500.00225 220 ml / Ø 60 x H 66 mm   3.15





Tulpenglas inkl. Deckel
Bocal tulipe incl. couvercle
«Weck»

8500.01100 1062 ml / Ø 100 x H 147 mm   3.70



Schmuckglas inkl. Deckel
Bocal fêtes incl. couvercle
«Weck»

8500.00250 560 ml / Ø 80 x H 88 mm   3.85





Tulpenglas inkl. Deckel
Bocal tulipe incl. couvercle
«Weck»

8500.01120 1750 ml / Ø 100 x H 190 mm   5.30





Schmuckglas inkl. Deckel
Bocal fêtes incl. couvercle
«Weck»

8500.02100 1062 ml / Ø 100 x H 105 mm   4.90





Tulpenglas inkl. Deckel
Bocal tulipe incl. couvercle
«Weck»

8500.01250 2700 ml / Ø 100 x H 242 mm   6.10



Gourmet-Sturzglas inkl. Deckel
Bocal droit gourmet incl. couvercle
«Weck»

8500.00300 300 ml / Ø 120 x H 48 mm   3.45

appetizer





Delikatessenglas inkl. Deckel
Bocal bobine incl. couvercle
«Weck»

8500.00100 110 ml / Ø 40 x H 103 mm   2.50



Mini-Zylinderglas inkl. Deckel
Bocal tube incl. couvercle
«Weck»

8500.00330 145 ml / Ø 40 x H 85 mm   2.65





Delikatessenglas inkl. Deckel
Bocal bobine incl. couvercle
«Weck»

8500.00110 200 ml / Ø 60 x H 122 mm   3.70



Zylinderglas inkl. Deckel
Bocal tube incl. couvercle
«Weck»

8500.00340 340 ml / Ø 60 x H 130 mm   3.45





Delikatessenglas inkl. Deckel
Bocal bobine incl. couvercle
«Weck»

8500.00120 370 ml / Ø 80 x H 122 mm   3.85



Zylinderglas inkl. Deckel
Bocal tube incl. couvercle
«Weck»

8500.00350 600 ml / Ø 60 x H 210 mm   3.85





Delikatessenglas inkl. Deckel
Bocal bobine incl. couvercle
«Weck»

8500.00130 700 ml / Ø 80 x H 205 mm   3.95



Zylinderglas inkl. Deckel
Bocal tube incl. couvercle
«Weck»

8500.03100 1040 ml / Ø 80 x H 210 mm   4.25





Saftflasche inkl. Deckel
Carafe incl. couvercle
«Weck»

8582.82307 290 ml / Ø 60 x H 140 mm   3.70





Zylinderglas inkl. Deckel
Bocal tube incl. couvercle
«Weck»

8500.03150 1590 ml / Ø 100 x H 210 mm   5.55





Saftflasche inkl. Deckel
Carafe incl. couvercle
«Weck»

8582.82308 530 ml / Ø 60 x H 184 mm   3.85





Zylinderglas inkl. Deckel
Bocal tube incl. couvercle
«Weck»

8500.03155 3300 ml / Ø 100 x H 242 mm   13.30



Saftflasche inkl. Deckel
Carafe incl. couvercle
«Weck»

8582.82309 1062 ml / Ø 60 x H 250 mm   4.90





Metallgriff klein
Anse en inox petit
«Weck»

8500.40810 Ø 60 mm / H 70 mm   3.95



Einweck-Klammern
Clips de couvercle
«Weck»

8582.82319 12 tlg / 12 pcs.   4.35













Metallgriff gross
Anse en inox grand
«Weck»

8500.40820 Ø 60 mm / H 100 mm   3.95



Einkochringe
Anneaux de stérilisation
«Weck»

8500.20040 Ø 40 mm / 10 tlg. / 10 pcs.   1.55
8582.82318 Ø 60 mm / 10 tlg. / 10 pcs.   1.95
8500.20220 Ø 80 mm / 10 tlg. / 10 pcs.   2.10
8500.20210 Ø 100 mm / 10 tlg. / 10 pcs.   2.35
8500.20120 Ø 120 mm / 10 tlg. / 10 pcs.   2.65













Edelstahldeckel
Couvercle en inox
«Weck»

8500.40801 Ø 100 mm   11.95



Ersatzdeckel
Couvercle réserve
«Weck»

8500.20340 Ø 40 mm   1.15
8500.20310 Ø 60 mm   1.15
8500.20320 Ø 80 mm   1.30
8500.20300 Ø 100 mm   1.30
8500.20350 Ø 120 mm   1.55





Edelstahlklappdeckel
Couvercle à charniere en inox
«Weck»

8500.40802 Ø 100 mm   15.85



Etiketten
Etiketten
«Weck»

8500.20280 100 Stk. / 100 pcs.   3.95



Holzdeckel
Couvercle en bois
«Weck»

8582.82318 Ø 60 mm   1.95
8500.20220 Ø 80 mm   2.10
8500.40803 Ø 100 mm   3.95











Glasheber
Porteur des bocaux
«Weck»

8500.20240   24.90



Frischhaltedeckel
Couvercle de conservation
«Weck»

8500.20275 Ø 40 mm / 5 tlg. / 5 pcs.   3.70
8500.20260 Ø 60 mm / 5 tlg. / 5 pcs.   3.70
8500.20270 Ø 80 mm / 5 tlg. / 5 pcs.   3.70
8500.20250 Ø 100 mm / 5 tlg. / 5 pcs.   5.55





Einfülltrichter
Entonnoir
«Weck»

8500.20230 Glas/Verres Ø 100 mm   16.40



Einmachtrichter
Entonnoir

8500.20235 Ø 4 cm x H 5,5 cm   6.10



coffeetime

- | | | | | |
|---|---|---|---|------|
|  | Espresso-Obertasse
Tasse à espresso seule
«Milano» | | | |
| 300-01051 | 7 cl |  |  | 3.70 |
|  | Espressountertasse
Soutasse à Espresso
«Milano» | | | |
| 300-02051 | 12 cm |  |  | 2.35 |
|  | Kaffeeobertasse
Tasse à café
«Milano» | | | |
| 300-03051 | 18 cl |  |  | 4.75 |
|  | Kaffeeuntertasse
Soutasse à café
«Milano» | | | |
| 300-04051 | 14 cm |  |  | 2.90 |
|  | Frühstücksobertasse
Tasse à déjeuner
«Milano» | | | |
| 300-05051 | 27 cl |  |  | 5.85 |
|  | Frühstücksuntertasse
Soutasse à déjeuner
«Milano» | | | |
| 300-06051 | 16 cm |  |  | 3.95 |
|  | Espresso-Obertasse, sehr dickwandig
Tasse à espresso seule, très épais
«Venezia» | | | |
| 300-20051 | 7 cl |  |  | 3.70 |
|  | Espresso-Obertasse
Tasse à espresso seule
«Roma» | | | |
| 300-10051 | 7 cl |  |  | 3.70 |
|  | Espressountertasse
Soutasse à Espresso
«Roma» | | | |
| 300-11051 | 12 cm |  |  | 2.35 |
|  | Kaffeeobertasse
Tasse à café
«Roma» | | | |
| 300-12051 | 18 cl |  |  | 4.75 |
|  | Kaffeeuntertasse
Soutasse à café
«Roma» | | | |
| 300-13051 | 14 cm |  |  | 2.90 |
|  | Frühstücksobertasse
Tasse à déjeuner
«Roma» | | | |
| 300-14051 | 27 cl |  |  | 5.85 |
|  | Frühstücksuntertasse
Soutasse à déjeuner
«Roma» | | | |
| 8001.57354 | 16 cm |  |  | 3.95 |



pizza



**Pizzateller
Assiette pizza**

50410024051 31 cm   6.90



**Pizzateller
Assiette pizza**

50410025051 33 cm   7.95





**Pizzateller
Assiette pizza**

50410026051 35 cm   13.05





**Pizzateller
Assiette pizza
«Pizza Pizza white»**

5042003169 31 cm   7.95





**Pizzateller
Assiette pizza
«Pizza Pizza white»**

5042003369 33 cm   9.05





**Pizzateller
Assiette pizza
«Pizza Pizza black»**

5042023170 31 cm   7.95



**Pizzateller
Assiette pizza
«Pizza Pizza black»**



5042023370 33 cm   9.05



gastronorm



Schale GN 1/1
Bac GN 1/1

8001.55510 53 x 32,5 x H 2 cm   109.85



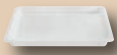

Schale GN 1/1
Bac GN 1/1

8001.55511 53 x 32,5 x H 6,5 cm   129.35



Schale GN 1/2
Bac GN 1/2

8001.55524 32,5 x 26,5 x H 2 cm   42.30

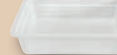



Schale GN 1/2
Bac GN 1/2

8001.55512 32,5 x 26,5 x H 6,5 cm   46.90





Schale GN 2/3
Bac GN 2/3

8001.55523 35,4 x 32,5 x H 2 cm   57.60





Schale GN 2/3
Bac GN 2/3

8001.55518 35,4 x 32,5 x H 6,5 cm   62.30





Schale GN 1/3
Bac GN 1/3

8001.55525 32,5 x 17,6 x H 2 cm   30.20





Schale GN 1/3
Bac GN 1/3

8001.55519 32,5 x 17,6 x H 6,5 cm   34.65



Schale GN 1/4
Bac GN 1/4

8001.55526 26,5 x 16,2 x H 2 cm   29.35





Schale GN 1/4
Bac GN 1/4

8001.55520 26,5 x 16,2 x H 6,5 cm   30.20



Schale GN 2/4
Bac GN 2/4

8001.55522 53 x 16,2 x H 2 cm   74.95





Schale GN 2/4
Bac GN 2/4

8001.55708 53 x 16,2 x H 6,5 cm   85.75





Schale GN 1/6
Bac GN 1/6

8001.55527 17,6 x 16,2 x H 2 cm   21.15



Schale GN 1/6
Bac GN 1/6





8001.55521 17,6 x 16,2 x H 6,5 cm   23.50

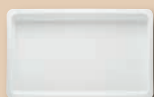

gn function





Schale GN 1/1
Bac GN 1/1

20112640051	53,0 x 32,5 x H 2,0 cm			99.80
20112611051	53,0 x 32,5 x H 6,5 cm			134.05









Schale GN 1/4
Bac GN 1/4

20112622051	32,5 x 17,5 x H 6,5 cm			33.40
-------------	------------------------	---	---	-------









Schale GN 1/2
Bac GN 1/2

20112616051	32,5 x 26,5 x H 2,0 cm			49.35
20112612051	32,5 x 26,5 x H 6,5 cm			69.80
20112626051	32,5 x 26,5 x H 10,5 cm			82.10







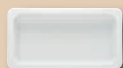

Schale GN 1/6
Bac GN 1/6

20112623051	17,6 x 16,2 x H 6,5 cm			22.30
20112624051	17,6 x 16,2 x H 10,5 cm			28.20
20112642051	17,6 x 16,2 x H 15,0 cm			38.80







Schale GN 1/3
Bac GN 1/3

20112641051	32,5 x 17,5 x H 2,0 cm			33.40
20112613051	32,5 x 17,5 x H 6,5 cm			38.80
20112621051	32,5 x 17,5 x H 10,5 cm			55.25







Schale GN 2/3
Bac GN 2/3

20112618051	35,4 x 32,5 x H 2,0 cm			66.95
20112625051	35,4 x 32,5 x H 6,5 cm			89.35



Schale GN 2/4
Bac GN 2/4

20112619051	53,0 x 16,5 x H 2,0 cm			55.25
20112620051	53,0 x 16,5 x H 6,5 cm			73.95



berndorf
LUZERN









colora



UNZERBRECHLICH! Hitzebeständig bis 200°C



Incassable! Résistant à la chaleur jusqu'à 200°C









 **Tasse PBT**
Tasse PBT
7073.10010 230 ml / H 79 mm / Ø 81 mm   6.65

 **Tasse PBT**
Tasse PBT
7073.10012 230 ml / H 79 mm / Ø 81 mm   6.65



 **Tasse PBT**
Tasse PBT
7073.10014 230 ml / H 79 mm / Ø 81 mm   6.65



 **Henkelbecher PBT**
Gobelet PBT
7073.10020 325 ml / H 90 mm / Ø 75 mm   7.95



 **Henkelbecher PBT**
Gobelet PBT
7073.10022 325 ml / H 90 mm / Ø 75 mm   7.95



 **Henkelbecher PBT**
Gobelet PBT
7073.10024 325 ml / H 90 mm / Ø 75 mm   7.95



 **Teller flach PBT**
Assiette plate PBT
7073.10040 Ø 241 mm   9.05





 **Teller flach PBT**
Assiette plate PBT
7073.10042 Ø 241 mm   9.05





 **Teller flach PBT**
Assiette plate PBT
7073.10044 Ø 241 mm   9.05





 **Teller tief PBT**
Assiette creuse PBT
7073.10030 500 ml / Ø 216 mm   7.95

 **Teller tief PBT**
Assiette creuse PBT
7073.10032 500 ml / Ø 216 mm   7.95

 **Teller tief PBT**
Assiette creuse PBT
7073.10034 500 ml / Ø 216 mm   7.95

 **Schüssel PBT**
Saladier PBT
7073.10060 H 45 mm / Ø 125 mm   4.90
7073.10070 H 65 mm / Ø 165 mm   6.65

 **Schüssel PBT**
Saladier PBT
7073.10062 H 45 mm / Ø 125 mm   4.90
7073.10072 H 65 mm / Ø 165 mm   6.65

 **Schüssel PBT**
Saladier PBT
7073.10064 H 45 mm / Ø 125 mm   4.90
7073.10074 H 65 mm / Ø 165 mm   6.65

Das Mehrweggeschirr aus PBT zeichnet sich durch seine besonders hohe Hitzebeständigkeit aus (bis 200°C). Zudem ist es bruch- und schlagfest, spülmaschinenbeständig, mikrowellengeeignet sowie geschmacks- und geruchsneutral. Dauerhafte Kontakthitze sollte vermieden werden (nicht auf Heizplatten stellen). Nicht in weiss erhältlich!

La vaisselle en PBT réutilisable se caractérise par une résistance à la chaleur particulièrement élevée (jusqu'à 200° C). En outre, il est incassable et résistant aux chocs, va au lave-vaisselle, convient au micro-ondes, insipide et inodore. La chaleur de contact permanente doit être évitée (ne pas mettre sur des plaques chauffantes). Ne pas disponible en couleur blanc.





Besteck | Couverts

**bali**

Seite/page 172

**tourbillon**

Seite/page 173

**impression**

Seite/page 174

**alpina**

Seite/page 175

**scandinavia**

Seite/page 176

**lareyna**

Seite/page 177

**pearl**

Seite/page 178

**savoy**

Seite/page 179

**primera**

Seite/page 180

**royal solitude**

Seite/page 181

**royal chippendale**

Seite/page 182

**filet classic**

Seite/page 183

**classic baguette**

Seite/page 184

**baguette vintage**

Seite/page 185

**royal baguette**

Seite/page 186

**mateo**

Seite/page 187

**palmilla**

Seite/page 188

**toccata**

Seite/page 189

**carlton**

Seite/page 190

**astoria**

Seite/page 191



ariane
Seite/page 192



absolut
Seite/page 193



palazzo
Seite/page 194



hermitage
Seite/page 195



joker
Seite/page 196



ovation
Seite/page 197



samoa
Seite/page 198



samoa vintage
Seite/page 199



atelier
Seite/page 200



timeless
Seite/page 201



capitol
Seite/page 202



belmore
Seite/page 203



filet beard
Seite/page 204



sahara
Seite/page 205

bali

Nicro-Edelstahl 18/10, Peek
Acier inoxydable 18/10, Peek



0988 001 211

Tafellöffel
Cuillère de table

21,2 cm / Ø 7,9mm

11.30



0988 011 211

Vorspeisenlöffel
Cuillère à hors-d'œuvre

16,5 cm / Ø 7,1mm

11.05



0988 037 211

Kaffeelöffel
Cuillère à café

13,4 cm / Ø 7,3mm

7.95



0988 055 211

Essstäbchen (Paar)
Baguettes (paire)

22 cm

24.00



0988 002 211

Tafelgabel
Fourchette de table

21,5 cm / Ø 7,9mm

11.30



0988 012 211

Vorspeisengabel
Fourchette à hors-d'œuvre

17,5 cm / Ø 7,1mm

11.05



0988 040 211

Espressolöffel
Cuillère à espresso

10,7 cm / Ø 6,1mm

7.30



0988 054 211

Essstäbchen-Ablage
Porte-baguettes

4 cm

4.95



0988 007 211

Tafelmesser
Couteau de table

22,1/11,5 cm

12.65



0988 017 211

Vorspeisenmesser
Couteau à hors-d'œuvre

18,7/10,1 cm

11.95

tourbillon

Nicro-Edelstahl 18/10, poliert
Acier inoxydable 18/10, poli



0474 001 100

Tafelöffel
Cuillère de table

20,6 cm / Ø 3,8 mm

7.55



0474 011 100

Vorspeisenöffel
Cuillère à hors-d'œuvre

18 cm / Ø 3,5 mm

6.95



0474 037 100

Kaffeelöffel
Cuillère à café

13,8 cm / Ø 2,5 mm

4.95



0474 026 100

Gourmetlöffel
Cuillère gourmet

18,5 cm / Ø 3,5 mm

7.55



0474 002 100

Tafelgabel
Fourchette de table

20,6 cm / Ø 3,8 mm

7.55



0474 012 100

Vorspeisengabel
Fourchette à hors-d'œuvre

18 cm / Ø 3,5 mm

6.95



0474 040 100

Espressolöffel
Cuillère à espresso

10,9 cm / Ø 2 mm

4.75



0474 008 100

Tafelmesser Hohlheft
Couteau de table manche creux

24,5/13,8 cm

11.90



0474 018 100

Vorspeisenmesser Mono
Couteau à hors-d'œuvre mono

21/11,8 cm

11.70



impression

Nicro-Edelstahl 18/10, poliert
Acier inoxydable 18/10, poli



0422 001 100

Tafellöffel
Cuillère de table

20,8 cm / Ø 9,7 mm

7.95



0422 011 100

Vorspeisenlöffel
Cuillère à hors-d'œuvre

18,3 cm / Ø 8,5 mm

7.85



0422 037 100

Kaffeelöffel
Cuillère à café

14,5 cm / Ø 6,9 mm

5.85



0422 026 100

Gourmetlöffel
Cuillère gourmet

18,3 cm / Ø 8,5 mm

7.95



0422 002 100

Tafelgabel
Fourchette de table

21,1 cm / Ø 9,7 mm

7.95



0422 012 100

Vorspeisengabel
Fourchette à hors-d'œuvre

18,6 cm / Ø 8,5 mm

7.85



0422 040 100

Espressolöffel
Cuillère à espresso

11,5 cm / Ø 5,5 mm

5.55



0422 008 100

Tafelmesser Hohlheft
Couteau de table manche creux

24,3/12 cm

9.30



0422 018 100

Vorspeisenmesser Hohlheft
Couteau à hors-d'œuvre manche creux

18,3/11,8 cm

9.15



alpina

antique matt

Nicro-Edelstahl 18/10, details oxidiert
Acier inoxydable 18/10, partiellement oxydé



0152 001 100
Tafellöffel
Cuillère de table
20 cm / Ø 3 mm
6.60



0152 037 100
Kaffeelöffel
Cuillère à café
13,9 cm / Ø 2 mm
4.95



0152 002 100
Tafelgabel
Fourchette de table
20 cm / Ø 3 mm
6.60



0152 040 100
Espressoöffel
Cuillère à espresso
11 cm / Ø 2 mm
4.85



0152 007 200
Tafelmesser Mono
Couteau de table mono
22/11,2 cm
7.95



0152 008 100
Tafelmesser Hohlheft
Couteau de table manche creux
22/11,2 cm
10.60

scandinavia



Nicro-Edelstahl 18/10, poliert
Acier inoxydable 18/10, poli



0485 001 100

Tafellöffel
Cuillère de table

21,1 cm / Ø 3,5 mm

4.45



0485 011 100

Vorspeisenlöffel
Cuillère à hors-d'œuvre

18,1 cm / Ø 3 mm

4.25



0485 037 100

Kaffeelöffel
Cuillère à café

14,5 cm / Ø 2,5 mm

2.95



0485 027 100

Limolöffel
Cuillère à limonade

19,5 cm / Ø 2,5 mm

3.95



0485 002 100

Tafelgabel
Fourchette de table

21,1 cm / Ø 3,5 mm

4.45



0485 012 100

Vorspeisengabel
Fourchette à hors-d'œuvre

18,1 cm / Ø 3 mm

4.25



0485 040 100

Espressolöffel
Cuillère à espresso

11 cm / Ø 2 mm

2.85



0485 007 200

Tafelmesser Mono
Couteau de table mono

24/12,2 cm

5.95



0485 017 200

Vorspeisenmesser Mono
Couteau à hors-d'œuvre mono

21,2/11,2 cm

5.75



lareyna

Nicro-Edelstahl 18/10, poliert
Acier inoxydable 18/10, poli



0390 001 100
Tafellöffel
Cuillère de table
19,3 cm / Ø 6,5 mm
5.50



0390 011 100
Vorspeisenlöffel
Cuillère à hors-d'œuvre
18,1 cm / Ø 5,7 mm
5.30



0390 037 100
Kaffeelöffel
Cuillère à café
14 cm / Ø 4,8 mm
3.50



0390 026 100
Gourmetlöffel
Cuillère gourmet
18 cm / Ø 5 mm
5.50



0390 002 100
Tafelgabel
Fourchette de table
19,7 cm / Ø 6,5 mm
5.50



0390 012 100
Vorspeisengabel
Fourchette à hors-d'œuvre
18,3 cm / Ø 5,6 mm
5.30



0390 040 100
Espressolöffel
Cuillère à espresso
11,5 cm / Ø 3,7 mm
3.40



0390 007 200
Tafelmesser Mono
Couteau de table mono
22,9/11,2cm
6.95



0390 017 200
Vorspeisenmesser Mono
Couteau à hors-d'œuvre mono
21,1/7,5cm
6.75



pearl



Nicro-Edelstahl 18/10, poliert
Acier inoxydable 18/10, poli



0177 001 100

Tafellöffel
Cuillère de table

20,7 cm / Ø 3,5 mm

5.50



0177 011 100

Vorspeisenlöffel
Cuillère à hors-d'œuvre

18,1 cm / Ø 3,0 mm

5.30



0177 037 100

Kaffeelöffel
Cuillère à café

14,2 cm / Ø 2,5 mm

3.50



0177 026 100

Gourmetlöffel
Cuillère gourmet

18,5 cm / Ø 3,0 mm

5.50



0177 002 100

Tafelgabel
Fourchette de table

20,7 cm / Ø 3,5 mm

5.50



0177 012 100

Vorspeisengabel
Fourchette à hors-d'œuvre

18,1 cm / Ø 3,0 mm

5.30



0177 040 100

Espressolöffel
Cuillère à espresso

11,5 cm / Ø 2,0 mm

3.40



0177 008 100

Tafelmesser Hohlheft
Couteau de table manche creux

24,3/16,2 cm

9.30



0177 018 100

Vorspeisenmesser Hohlheft
Couteau à hors-d'œuvre manche creux

21,2/11,4 cm

9.15



savoy

Nicro-Edelstahl 18/10, poliert
Acier inoxydable 18/10, poli



0189 001 100
Tafellöffel
Cuillère de table
19,9 cm / Ø 4,5 mm
5.25



0189 011 100
Vorspeisenlöffel
Cuillère à hors-d'œuvre
18,5 cm / Ø 4,0 mm
4.95



0189 037 100
Kaffeelöffel
Cuillère à café
13,5 cm / Ø 3,0 mm
3.25



0189 026 100
Gourmetlöffel
Cuillère gourmet
18,5 cm / Ø 4,0 mm
5.25



0189 002 100
Tafelgabel
Fourchette de table
19,9 cm / Ø 4,5 mm
5.25



0189 012 100
Vorspeisengabel
Fourchette à hors-d'œuvre
18,5 cm / Ø 4,0 mm
4.95



0189 040 100
Espressolöffel
Cuillère à espresso
11,1 cm / Ø 2,5 mm
2.95



0189 008 100
Tafelmesser Hohlheft
Couteau de table manche creux
22,5/10,5 cm
9.30



0189 018 100
Vorspeisenmesser Hohlheft
Couteau à hors-d'œuvre manche creux
20/9,3 cm
9.15



primera

Nicro-Edelstahl 18/10, poliert
Acier inoxydable 18/10, poli



0380 001 100

Tafelöffel
Cuillère de table

20,7 cm / Ø 4,2 mm
4.75



0380 011 100

Vorspeisenöffel
Cuillère à hors-d'œuvre

18,3 cm / Ø 3,8 mm
4.65



0380 037 100

Kaffeeöffel
Cuillère à café

14 cm / Ø 3 mm
2.50



0380 026 100

Gourmetöffel
Cuillère de table

18,1 cm / Ø 3,8 mm
4.75



0380 002 100

Tafelgabel
Fourchette de table

21,3 cm / Ø 4,2 mm
4.75



0380 012 100

Vorspeisengabel
Fourchette à hors-d'œuvre

18,5 cm / Ø 3,8 mm
4.65



0380 040 100

Espressoöffel
Cuillère à espresso

11 cm / Ø 3 mm
2.25



0380 016 100

Steakmesser Hohlheft
Couteau à steak manche creux

24,5/12,3 cm
9.30



0380 007 200

Tafelmesser Mono
Couteau de table mono

23/6,8 cm
5.30



0380 017 200

Vorspeisenmesser Mono
Couteau à hors-d'œuvre mono

20,2/6,8 cm
5.25



0380 088 100

Butterstreicher
Couteau à beurre

17,5 cm / Ø 6,4 mm
5.05



0380 008 100

Tafelmesser Hohlheft
Couteau de table manche creux

24,5/12,3 cm
9.30



0380 018 100

Vorspeisenmesser Hohlheft
Couteau à hors-d'œuvre manche creux

21,7/11 cm
9.15

royal solitude

Nicro-Edelstahl 18/10, poliert
Acier inoxydable 18/10, poli



0169 001 100
Tafellöffel
Cuillère de table
19,7 cm / Ø 3 mm
5.95



0169 011 100
Vorspeisenlöffel
Cuillère à hors-d'œuvre
17,8 cm / Ø 3 mm
5.50



0169 037 100
Kaffeelöffel
Cuillère à café
13,7 cm / Ø 2 mm
3.50



0169 026 100
Gourmetlöffel
Cuillère gourmet
19 cm / Ø 2,5 mm
5.95



0169 002 100
Tafelgabel
Fourchette de table
19,4 cm / Ø 3 mm
5.95



0169 012 100
Vorspeisengabel
Fourchette à hors-d'œuvre
17,9 cm / Ø 2,5 mm
5.50



0169 040 100
Espressolöffel
Cuillère à espresso
11,3 cm / Ø 2 mm
3.25



0169 029 100
Fischgabel
Fourchette à poisson
18,1 cm / Ø 3 mm
5.95



0169 008 100
Tafelmesser Hohlheft
Couteau de table manche creux
22,8/12 cm
11.95



0169 018 100
Vorspeisenmesser Hohlheft
Couteau à hors-d'œuvre manche creux
19,9/10,2 cm
11.85



royal chippendale



Nicro-Edelstahl 18/10, poliert
Acier inoxydable 18/10, poli



0196 001 100

Tafellöffel
Cuillère de table
20,1 cm / Ø 3 mm
5.95



0196 009 100

Vorspeisenlöffel
Cuillère à hors-d'œuvre
18,8 cm / Ø 3,5 mm
5.75



0196 037 100

Kaffeelöffel
Cuillère à café
13,2 cm / Ø 3 mm
3.50



0196 021 100

Kuchengabel
Fourchette à gâteau
15,6 cm / Ø 2 mm
4.95



0196 002 100

Tafelgabel
Fourchette de table
20,1 cm / Ø 3 mm
5.95



0196 010 100

Vorspeisengabel
Fourchette à hors-d'œuvre
19,1 cm / Ø 3,5 mm
5.75



0196 040 100

Espressolöffel
Cuillère à espresso
11,5 cm / Ø 3 mm
3.25



0196 026 100

Gourmetlöffel
Cuillère gourmet
18,9 cm / Ø 3 mm
5.95



0196 008 100

Tafelmesser Hohlheft
Couteau de table manche creux
23,6/12,5 cm
11.95



0196 019 100

Vorspeisenmesser Hohlheft
Couteau à hors-d'œuvre manche creux
21,2/11 cm
11.85



filet classic

Nicro-Edelstahl 18/10, poliert
Acier inoxydable 18/10, poli



0118 001 100
Tafellöffel
Cuillère de table
20,7 cm / Ø 3,5 mm
5.25



0118 011 100
Vorspeisenlöffel
Cuillère à hors-d'œuvre
17,9 cm / Ø 3,5 mm
4.95



0118 037 100
Kaffeelöffel
Cuillère à café
13,8 cm / Ø 3 mm
3.25



0118 021 100
Kuchengabel
Fourchette à gâteau
13,8 cm / Ø 3,5 mm
3.95



0118 002 100
Tafelgabel
Fourchette de table
20,4 cm / Ø 3,5 mm
5.25



0118 012 100
Vorspeisengabel
Fourchette à hors-d'œuvre
17,7 cm / Ø 3,5 mm
4.95



0118 040 100
Espressolöffel
Cuillère à espresso
11 cm / Ø 3 mm
2.95



0118 028 100
Fischmesser
Couteau à poisson
19,8 cm / Ø 3,5 mm
5.25

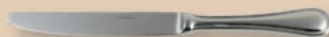

0118 008 100
Tafelmesser Hohlheft
Couteau de table manche creux
24,6/13,8 cm
9.30



0118 018 100
Vorspeisenmesser Hohlheft
Couteau à hors-d'œuvre manche creux
20,5/12,6 cm
9.15



72611-67
Limolöffel
Cuillère à limonade
18,1 cm / Ø 2 mm
3.95



0118 088 100
Butterstreicher
Couteau à beurre
18,6 cm / Ø 9,4 mm
8.65



classic baguette



Nicro-Edelstahl 18/10, poliert
Acier inoxydable 18/10, poli



0120 001 100

Tafelöffel
Cuillère de table

20,6 cm / Ø 2,5 mm

4.50



0120 011 100

Vorspeisenöffel
Cuillère à hors-d'œuvre

18,9 cm / Ø 3 mm

3.95



0120 037 100

Kaffeelöffel
Cuillère à café

13,9 cm / Ø 2 mm

2.60



0120 026 100

Gourmetöffel
Cuillère gourmet

18,6 cm / Ø 3 mm

4.50



0120 002 100

Tafelgabel
Fourchette de table

20,6 cm / Ø 2,5 mm

4.50



0120 012 100

Vorspeisengabel
Fourchette à hors-d'œuvre

19,1 cm / Ø 2,5 mm

3.95



0120 040 100

Espressolöffel
Cuillère à espresso

11,1 cm / Ø 2 mm

2.50



0120 029 100

Fischgabel
Fourchette à poisson

19,2 cm / Ø 3 mm

4.50



0120 007 200

Tafelmesser Mono
Couteau de table mono

22,9/12,2 cm

5.75



0120 017 200

Vorspeisenmesser Mono
Couteau à hors-d'œuvre mono

19,5/10,7 cm

5.30



0120 027 100

Limolöffel
Cuillère à limonade

18,4 cm / Ø 2,8 mm

3.40



0120 028 100

Fischmesser
Couteau à poisson

21,2 cm / Ø 3 mm

4.50



0120 008 100

Tafelmesser Hohlheft
Couteau de table manche creux

22,9/12,2 cm

7.95



0120 018 100

Vorspeisenmesser Hohlheft
Couteau à hors-d'œuvre manche creux

19,5/10,7 cm

7.85



0119 021 100

Kuchengabel
Fourchette à gâteau

15,3 cm / Ø 2 mm

3.60



0120 089 100

Butterstreicher Hohlheft
Couteau à beurre manche creux

17,5 cm / Ø 6,9 mm

6.95



0120 008 114

Tafelmesser Hohlheft
Couteau de table manche creux
kanneliert/cannelé

22,9/12,2 cm

7.95



0120 018 114

Vorspeisenmesser Hohlheft
Couteau à hors-d'œuvre manche creux
kanneliert/cannelé

19,5/10,7 cm

7.85

classic baguette

vintage

Nicro-Edelstahl 18/10, trowalisiert
Acier inoxydable 18/10, trovalisé



0120 001 333

Tafellöffel
Cuillère de table

20,6 cm / Ø 2,5 mm
7.95



0120 011 333

Vorspeisenlöffel
Cuillère à hors-d'œuvre

18,9 cm / Ø 3 mm
7.70



0120 037 333

Kaffeelöffel
Cuillère à café

13,9 cm / Ø 2 mm
5.30



0120 026 333

Gourmetlöffel
Cuillère gourmet

18,6 cm / Ø 3 mm
7.95



0120 002 333

Tafelgabel
Fourchette de table

20,6 cm / Ø 2,5 mm
7.95



0120 012 333

Vorspeisengabel
Fourchette à hors-d'œuvre

19,1 cm / Ø 2,5 mm
7.70



0120 040 333

Espressolöffel
Cuillère à espresso

11,1 cm / Ø 2 mm
5.05



0120 029 333

Fischgabel
Fourchette à poisson

19,2 cm / Ø 3 mm
7.95



0120 007 333

Tafelmesser Mono
Couteau de table mono

22,9/12,2 cm
9.30



0120 017 333

Vorspeisenmesser Mono
Couteau à hors-d'œuvre mono

19,5/10,7 cm
8.90



0120 027 333

Limolöffel
Cuillère à limonade

18,4 cm / Ø 2,8 mm
6.10



0120 028 333

Fischmesser
Couteau à poisson

21,2 cm / Ø 3 mm
7.95



0120 008 333

Tafelmesser Hohlheft
Couteau de table manche creux

22,9/12,2 cm
15.90



0120 018 333

Vorspeisenmesser Hohlheft
Couteau à hors-d'œuvre manche creux

19,5/10,7 cm
15.30



0120 021 333

Kuchengabel
Fourchette à gâteau

15,3 cm / Ø 2 mm
6.10



0120 089 333

Butterstreicher Hohlheft
Couteau à beurre manche creux

17,5 cm / Ø 6,9 mm
13.30



0120 008 334

Tafelmesser Hohlheft
Couteau de table manche creux
kanneliert/cannelé

22,9/12,2 cm
15.90



0120 018 334

Vorspeisenmesser Hohlheft
Couteau à hors-d'œuvre manche creux
kanneliert/cannelé

19,5/10,7 cm
15.30

royal baguette



Nicro-Edelstahl 18/10, poliert
Acier inoxydable 18/10, poli



0119 001 100

Tafellöffel
Cuillère de table
18,6 cm / Ø 3 mm
3.95



0119 011 100

Vorspeisenlöffel
Cuillère à hors-d'œuvre
15,6 cm / Ø 3 mm
3.85



0119 037 100

Kaffeelöffel
Cuillère à café
13,1 cm / Ø 3 mm
2.45



0120 026 100

Gourmetlöffel
Cuillère gourmet
18,6 cm / Ø 3 mm
4.50



0119 002 100

Tafelgabel
Fourchette de table
18,6 cm / Ø 3 mm
3.95



0119 012 100

Vorspeisengabel
Fourchette à hors-d'œuvre
15,6 cm / Ø 3 mm
3.85



0119 040 100

Espressolöffel
Cuillère à espresso
11,6 cm / Ø 3 mm
2.35



0120 029 100

Fischgabel
Fourchette à poisson
19,2 cm / Ø 3 mm
4.50



0119 008 100

Tafelmesser Hohlheft
Couteau de table manche creux
21,2/10,3 cm
7.95



0119 018 100

Vorspeisenmesser Hohlheft
Couteau à hors-d'œuvre manche creux
18,3/8,8 cm
7.95



0120 027 100

Limolöffel
Cuillère à limonade
18,4 cm / Ø 2,8 mm
3.40



0120 028 100

Fischmesser
Couteau à poisson
21,2 cm / Ø 3 mm
4.50



0119 021 100

Kuchengabel
Fourchette à gâteau
15,3 cm / Ø 2 mm
3.60



0120 089 100

Butterstreicher Hohlheft
Couteau à beurre manche creux
17,5 cm / Ø 6,9 mm
6.95



mateo

Nicro-Edelstahl 18/10, poliert
Acier inoxydable 18/10, poli



0447 001 100
Tafellöffel
Cuillère de table
21,0 cm / Ø 3 mm
4.50



0447 011 100
Vorspeisenlöffel
Cuillère à hors-d'œuvre
18,4 cm / Ø 3 mm
4.35



0447 037 100
Kaffeelöffel
Cuillère à café
14,8 cm / Ø 3 mm
2.65



0447 029 100
Fischgabel
Fourchette à poisson
18,5 cm / Ø 3 mm
4.50



0447 002 100
Tafelgabel
Fourchette de table
21,2 cm / Ø 3 mm
4.50



0447 012 100
Vorspeisengabel
Fourchette à hors-d'œuvre
18,7 cm / Ø 3 mm
4.35



0447 040 100
Espressolöffel
Cuillère à espresso
10,9 cm / Ø 3 mm
2.55



0447 028 100
Fischmesser
Couteau à poisson
20,7 cm / Ø 3 mm
4.50



0447 007 200
Tafelmesser Mono
Couteau de table mono
22,5/10,0 cm
6.50



0447 017 200
Vorspeisenmesser Mono
Couteau à hors-d'œuvre mono
20,1/9,6 cm
6.35



0447 021 100
Kuchengabel
Fourchette à gâteau
16,1 cm / Ø 3 mm
3.75



palmilla

matt



Nicro-Edelstahl 18/10, gebürstet
Acier inoxydable 18/10, brossé



0866 001 101

Tafellöffel
Cuillère de table

19,7 cm / Ø 3,5 mm

4.50



0866 011 101

Vorspeisenlöffel
Cuillère à hors-d'œuvre

17,8 cm / Ø 3,5 mm

4.35



0866 037 101

Kaffeelöffel
Cuillère à café

14,6 cm / Ø 3 mm

2.65



0866 026 101

Gourmetlöffel
Cuillère gourmet

18,7 cm / Ø 3,5 mm

4.50



0866 002 101

Tafelgabel
Fourchette de table

20,3 cm / Ø 3,5 mm

4.50



0866 012 101

Vorspeisengabel
Fourchette à hors-d'œuvre

18,0 cm / Ø 3,5 mm

4.35



0866 040 101

Espressolöffel
Cuillère à espresso

11,6 cm / Ø 2,8 mm

2.55



0866 007 201

Tafelmesser Mono
Couteau de table mono

22,2/10,2 cm

6.50



0866 017 201

Vorspeisenmesser Mono
Couteau à hors-d'œuvre mono

19,9/9,1 cm

6.35

toccata

Nicro-Edelstahl 18/10, gehämmert
Acier inoxydable 18/10, martelé



0704 001 100
Tafellöffel
Cuillère de table
20,1 cm / Ø 3,8 mm
4.75



0704 011 100
Vorspeisenlöffel
Cuillère à hors-d'œuvre
18,5 / Ø 3,3 mm
4.35



0704 037 100
Kaffeelöffel
Cuillère à café
14,5 / Ø 3,3 mm
2.65



0704 026 100
Gourmetlöffel
Cuillère gourmet
18,8 cm / Ø 3,5 mm
4.75



0704 002 100
Tafelgabel
Fourchette de table
20 cm / Ø 3,8 mm
4.75



0704 012 100
Vorspeisengabel
Fourchette à hors-d'œuvre
18,2 cm / Ø 3,3 mm
4.35



0704 040 100
Espressolöffel
Cuillère à espresso
11,2 / Ø 2,8 mm
2.55



0704 007 200
Tafelmesser Mono
Couteau de table mono
22,5/10,5 cm
6.50



0704 017 200
Vorspeisenmesser Mono
Couteau à hors-d'œuvre mono
20,8/9,7 cm
6.35



0704 027 100
Limolöffel
Cuillère à limonade
18,5 cm / Ø 2,7 mm
3.80



0704 008 100
Tafelmesser Hohlheft
Couteau de table manche creux
22,5/10,5 cm
9.30



0704 018 100
Vorspeisenmesser Hohlheft
Couteau à hors-d'œuvre, manche creux
20,8/9,7 cm
9.15



carlton

Nicro-Edelstahl 18/10, poliert
Acier inoxydable 18/10, poli



0323 001 100

Tafelöffel
Cuillère de table
20,9 cm / Ø 3 mm
3.95



0323 011 100

Vorspeisenöffel
Cuillère à hors-d'œuvre
18,5 cm / Ø 3 mm
3.85



0323 037 100

Kaffeelöffel
Cuillère à café
13,7 cm / Ø 3 mm
2.65



0323 026 100

Gourmetöffel
Cuillère gourmet
19,2 cm / Ø 3 mm
3.95



0323 002 100

Tafelgabel
Fourchette de table
20,9 cm / Ø 3 mm
3.95



0323 012 100

Vorspeisengabel
Fourchette à hors-d'œuvre
18,5 cm / Ø 3 mm
3.85



0323 040 100

Espressolöffel
Cuillère à espresso
11,2 cm / Ø 2,5 mm
2.50



0323 029 100

Fischgabel
Fourchette à poisson
18,6 cm / Ø 3 mm
3.95



0323 008 100

Tafelmesser Hohlheft
Couteau de table manche creux
23,2/12,5 cm
7.95



0323 018 100

Vorspeisenmesser Hohlheft
Couteau à hors-d'œuvre manche creux
20,5/11,1 cm
7.85



0323 021 100

Kuchengabel
Fourchette à gâteau
15,9 cm / Ø 2,5 mm
2.95



0323 028 100

Fischmesser
Couteau à poisson
20,6 cm / Ø 3 mm
3.95



0323 027 100

Limolöffel
Cuillère à limonade
23,5 cm / Ø 2,5 mm
3.15

astoria

Nicro-Edelstahl 18/10, poliert
Acier inoxydable 18/10, poli



0555 001 100
Tafellöffel
Cuillère de table
20,2 cm / Ø 2 mm
4.50



0555 011 100
Vorspeisenlöffel
Cuillère à hors-d'œuvre
17,8 cm / Ø 2 mm
4.35



0555 037 100
Kaffeelöffel
Cuillère à café
13,4 cm / Ø 1 mm
2.65



0555 021 100
Kuchengabel
Fourchette à gâteau
14,8 cm / Ø 1 mm
3.45



0555 002 100
Tafelgabel
Fourchette de table
20,2 cm / Ø 2 mm
4.50



0555 012 100
Vorspeisengabel
Fourchette à hors-d'œuvre
17,8 cm / Ø 2 mm
4.35



0555 040 100
Espressolöffel
Cuillère à espresso
10,9 cm / Ø 1 mm
2.25



0555 007 200
Tafelmesser Mono
Couteau de table mono
22,9/10,5 cm
6.50



0555 017 200
Vorspeisenmesser Mono
Couteau à hors-d'œuvre mono
20,1/9,9 cm
6.35



ariane

Nicro-Edelstahl 18/10, poliert
Acier inoxydable 18/10, poli



0110 001 100

Tafelöffel
Cuillère de table

19,3 cm / Ø 2,5 mm
4.50



0110 011 100

Vorspeisenlöffel
Cuillère à hors-d'œuvre

16,9 cm / Ø 2,5 mm
4.35



0110 037 100

Kaffeelöffel
Cuillère à café

13,7 cm / Ø 2 mm
2.65



0110 002 100

Tafelgabel
Fourchette de table

19,1 cm / Ø 2,5 mm
4.50



0110 012 100

Vorspeisengabel
Fourchette à hors-d'œuvre

17,1 cm / Ø 2,5 mm
4.35



0110 040 100

Espressolöffel
Cuillère à espresso

11,6 cm / Ø 2 mm
2.55



0110 007 200

Tafelmesser Mono
Couteau de table mono

21,8/10 cm
5.75



0110 017 200

Vorspeisenmesser Mono
Couteau à hors-d'œuvre mono

18,3/7,8 cm
5.50



0110 008 100

Tafelmesser Hohlheft
Couteau de table manche creux

21,6/10,3 cm
10.60



0110 018 100

Vorspeisenmesser Hohlheft
Couteau à hors-d'œuvre manche creux

18,3/8,7 cm
10.50



absolüt

Nicro-Edelstahl 18/10, poliert
Acier inoxydable 18/10, poli



0874 001 100
Tafellöffel
Cuillère de table
22,3 cm / Ø 3 mm
3.85



0874 011 100
Vorspeisenlöffel
Cuillère à hors-d'œuvre
19 cm / Ø 3 mm
3.55



0874 037 100
Kaffeelöffel
Cuillère à café
13,9 cm / Ø 2 mm
2.35



0874 026 100
Gourmetlöffel
Cuillère gourmet
19 cm / Ø 3 mm
3.85



0874 002 100
Tafelgabel
Fourchette de table
20,2 cm / Ø 3 mm
3.85



0874 012 100
Vorspeisengabel
Fourchette à hors-d'œuvre
19 cm / Ø 3 mm
3.55



0874 040 100
Espressolöffel
Cuillère à espresso
11 cm / Ø 2 mm
2.25



0874 007 200
Tafelmesser Mono
Couteau de table mono
23,5/12,3 cm
5.25



0874 017 200
Vorspeisenmesser Mono
Couteau à hors-d'œuvre mono
21,5/11,2 cm
5.15



palazzo

Nicro-Edelstahl 18/10, poliert
Acier inoxydable 18/10, poli



0122 001 100
Tafellöffel
Cuillère de table
20 cm / Ø 3 mm
3.85



0122 037 100
Kaffeelöffel
Cuillère à café
14,5 cm / Ø 2,5 mm
2.35



0122 002 100
Tafelgabel
Fourchette de table
20 cm / Ø 3 mm
3.85



0122 040 100
Espressolöffel
Cuillère à espresso
11,4 cm / Ø 2 mm
2.25



0122 007 200
Tafelmesser Mono
Couteau de table mono
23,5/13 cm
4.65



hermitage

Nicro-Edelstahl 18/10, poliert
Acier inoxydable 18/10, poli



0414 001 100
Tafellöffel
Cuillère de table
18,5 cm / Ø 3 mm
2.95



0414 037 100
Kaffeelöffel
Cuillère à café
13,2 cm / Ø 3 mm
1.65



0414 026 100
Gourmetlöffel
Cuillère gourmet
19 cm / Ø 3 mm
2.95



0414 002 100
Tafelgabel
Fourchette de table
18,8 cm / Ø 3 mm
2.95



0589 040 100
Espressolöffel
Cuillère à espresso
11,0 cm / Ø 1 mm
1.25



0414 007 200
Tafelmesser Mono
Couteau de table mono
20,7/9 cm
3.95



0589 021 100
Kuchengabel
Fourchette à gâteau
15,0 cm / Ø 2 mm
2.35



joker

top
price

Nicro-Edelstahl 18/10, poliert
Acier inoxydable 18/10, poli



0211 001 100
Tafellöffel
Cuillère de table
18,6 cm / Ø 3 mm
2.65



0211 037 100
Kaffeelöffel
Cuillère à café
13,4 cm / Ø 2 mm
1.50



0211 027 100
Limolöffel
Cuillère à limonade
18,4 cm / Ø 2 mm
2.25



0211 002 100
Tafelgabel
Fourchette de table
18,6 cm / Ø 3 mm
2.65



0211 040 100
Espressolöffel
Cuillère à espresso
11,5 cm / Ø 2 mm
1.45



0211 021 100
Kuchengabel
Fourchette à gâteau
15,9 cm / Ø 2 mm
2.15



0211 007 200
Tafelmesser Mono
Couteau de table mono
20,6/9,2 cm
3.45

ovation

Nicro-Edelstahl 18/10, poliert
Acier inoxydable 18/10, poli



0554 001 100
Tafellöffel
Cuillère de table
20,3 cm / Ø 4 mm
7.95



0554 011 100
Vorspeisenlöffel
Cuillère à hors-d'œuvre
18,2 cm / Ø 3 mm
7.70



0554 037 100
Kaffeelöffel
Cuillère à café
14,1 cm / Ø 2,5 mm
3.95



0554 002 100
Tafelgabel
Fourchette de table
20,1 cm / Ø 4 mm
7.95



0554 012 100
Vorspeisengabel
Fourchette à hors-d'œuvre
18,1 cm / Ø 3 mm
7.70



0554 040 100
Espressolöffel
Cuillère à espresso
12,3 cm / Ø 2,5 mm
3.75



0554 007 200
Tafelmesser Mono
Couteau de table mono
22,7/11 cm
9.30



0554 017 200
Vorspeisenmesser Mono
Couteau à hors-d'œuvre mono
20,2/9,8 cm
9.15



samoa



Nicro-Edelstahl 18/10, poliert
Acier inoxydable 18/10, poli



0589 001 100

Tafellöffel
Cuillère de table

20,2 cm / Ø 2,5 mm

2.65



0589 011 100

Vorspeisenlöffel
Cuillère à hors-d'œuvre

18,5 cm / Ø 2,5 mm

2.55



0589 037 100

Kaffeelöffel
Cuillère à café

13,4 cm / Ø 2 mm

1.30



0589 002 100

Tafelgabel
Fourchette de table

20,4 cm / Ø 2,5 mm

2.65



0589 012 100

Vorspeisengabel
Fourchette à hors-d'œuvre

18,6 cm / Ø 2,5 mm

2.55



0589 040 100

Espressolöffel
Cuillère à espresso

11,0 cm / Ø 1 mm

1.25



0589 007 200

Tafelmesser Mono
Couteau de table mono

22,4/9,8 cm

3.25



0589 017 200

Vorspeisenmesser Mono
Couteau à hors-d'œuvre mono

20,6/9,5 cm

3.15



0589 021 100

Kuchengabel
Fourchette à gâteau

15,0 cm / Ø 2 mm

2.35



samoa

vintage

Nicro-Edelstahl 18/10, trowalisiert
Acier inoxydable 18/10, trovalisé



0589 001 333

Tafellöffel
Cuillère de table

20,2 cm / Ø 2,5 mm

5.30



0589 011 333

Vorspeisenlöffel
Cuillère à hors-d'œuvre

18,5 cm / Ø 2,5 mm

5.05



0589 037 333

Kaffeelöffel
Cuillère à café

13,4 cm / Ø 2 mm

3.70



0589 002 333

Tafelgabel
Fourchette de table

20,4 cm / Ø 2,5 mm

5.30



0589 012 333

Vorspeisengabel
Fourchette à hors-d'œuvre

18,6 cm / Ø 2,5 mm

5.05



0589 040 333

Espressolöffel
Cuillère à espresso

11,0 cm / Ø 1 mm

3.45



0589 007 333

Tafelmesser Mono
Couteau de table mono

22,4/9,8 cm

6.60



0589 017 333

Vorspeisenmesser Mono
Couteau à hors-d'œuvre mono

20,6/9,5 cm

6.50



0589 021 333

Kuchengabel
Fourchette à gâteau

15,0 cm / Ø 2 mm

3.95



atelier



Nicro-Edelstahl 18/10, poliert
Acier inoxydable 18/10, poli



0670 001 100
Tafellöffel
Cuillère de table
20,2 cm / Ø 3 mm
3.95



0670 011 100
Vorspeisenlöffel
Cuillère à hors-d'œuvre
18,5 cm / Ø 3 mm
3.85



0670 037 100
Kaffeelöffel
Cuillère à café
14,2 cm / Ø 3 mm
2.35



0670 002 100
Tafelgabel
Fourchette de table
20,1 cm / Ø 3 mm
3.95



0670 012 100
Vorspeisengabel
Fourchette à hors-d'œuvre
18,5 cm / Ø 3 mm
3.85



0670 040 100
Espressolöffel
Cuillère à espresso
10,9 cm / Ø 2,5 mm
2.25



0670 007 200
Tafelmesser Mono
Couteau de table mono
22,0/11,2 cm
4.75



0670 017 200
Vorspeisenmesser Mono
Couteau à hors-d'œuvre mono
20/10,3 cm
4.65

 JOLIE TABLE



timeless



8002.70000
Tafellöffel
Cuillère de table
20,6 cm / Ø 3,5 mm
3.15



8002.70300
Vorspeisenlöffel
Cuillère à hors-d'œuvre
18,8 cm / Ø 3,5 mm
3.05



8002.70100
Kaffeelöffel
Cuillère à café
14,5 cm / Ø 3 mm
2.10



8002.70700
Gourmetlöffel
Cuillère gourmet
18,8 cm / Ø 3,5 mm
3.15



8002.70010
Tafelgabel
Fourchette de table
20,6 cm / Ø 3,5 mm
3.15



8002.70310
Vorspeisengabel
Fourchette à hors-d'œuvre
18,8 cm / Ø 3,5 mm
3.05



8002.70200
Espressolöffel
Cuillère à espresso
11,2 cm / Ø 3 mm
1.95



8002.70020
Tafelmesser Mono
Couteau de table mono
23,4/11,5 cm
4.20



8002.70320
Vorspeisenmesser Mono
Couteau à hors-d'œuvre mono
21/10,3 cm
3.95

JOLIE TABLE

capitol



Nicro-Edelstahl 18/10, poliert
Acier inoxydable 18/10, poli



7722.02000

Tafellöffel
Cuillère de table

20,4 cm / Ø 3,5 mm

5.55



7722.02300

Vorspeisenlöffel
Cuillère à hors-d'œuvre

18,6 cm / Ø 3,5 mm

5.30



7722.02100

Kaffeelöffel
Cuillère à café

14,1 cm / Ø 3 mm

3.45



7722.02700

Gourmetlöffel
Cuillère gourmet

19 cm / Ø 2,7 mm

5.55



7722.02010

Tafelgabel
Fourchette de table

20,3 cm / Ø 3,5 mm

5.55



7722.02310

Vorspeisengabel
Fourchette à hors-d'œuvre

18,7 cm / Ø 3,5 mm

5.30



7722.02200

Espressolöffel
Cuillère à espresso

11,5 cm / Ø 3 mm

3.15



7722.02020

Tafelmesser Mono
Couteau de table mono

22,6/11,1 cm

7.05



7722.02320

Vorspeisenmesser Mono
Couteau à hors-d'œuvre mono

21/10,3 cm

6.65



belmore

Nicro-Edelstahl 18/10, poliert
Acier inoxydable 18/10, poli



7733.02000
Tafellöffel
Cuillère de table
21 cm / Ø 3,5 mm
4.20



7733.02300
Vorspeisenlöffel
Cuillère à hors-d'œuvre
18,8 cm / Ø 3,5 mm
3.95



7733.02100
Kaffeelöffel
Cuillère à café
14 cm / Ø 3 mm
2.65



7733.02700
Gourmetlöffel
Cuillère gourmet
18,7 cm / Ø 2,7 mm
4.20



7733.02010
Tafelgabel
Fourchette de table
21 cm / Ø 3,5 mm
4.20



7733.02310
Vorspeisengabel
Fourchette à hors-d'œuvre
18,7 cm / Ø 3,5 mm
3.95



7733.02200
Espressolöffel
Cuillère à espresso
11,5 cm / Ø 3 mm
2.35



7733.02020
Tafelmesser Mono
Couteau de table mono
24,1/12,3 cm
5.30



7733.02320
Vorspeisenmesser Mono
Couteau à hors-d'œuvre mono
21,5/11 cm
5.05

BEARD®
SOLUTIONS HORECA

filet béard



Nicro-Edelstahl 18/10, poliert
Acier inoxydable 18/10, poli



0701 001 100

Tafellöffel
Cuillère de table

20,3 cm / Ø 3,5 mm

4.95



0701 011 100

Vorspeisenlöffel
Cuillère à hors-d'œuvre

17,7 cm / Ø 2,5

4.85



0701 037 100

Kaffeelöffel
Cuillère à café

14,0 cm / Ø 2 mm

2.65



72611-49

Fischgabel
Fourchette à poisson

18,0 cm / Ø 2,5 mm

4.95



0701 002 100

Tafelgabel
Fourchette de table

20,5 cm / Ø 3,5 mm

4.95



0701 012 100

Vorspeisengabel
Fourchette à hors-d'œuvre

18,1 cm / Ø 2,5 mm

4.85



0701 040 100

Espressolöffel
Cuillère à espresso

12,0 cm / Ø 2 mm

2.60



72611-50

Fischmesser
Couteau à poisson

19,8 cm / Ø 2,5 mm

4.95



0701 007 200

Tafelmesser, Mono
Couteau de table, mono

23,0/12,3 cm

6.50



0701 017 200

Vorspeisenmesser, Mono
Couteau à hors-d'œuvre, mono

20,8/11,0 cm

6.40



72611-55

Kuchengabel
Fourchette à gâteau

14,6 cm / Ø 2 mm

3.85



72611-69

Gourmetlöffel
Cuillère gourmet

18,1 cm / Ø 2,5 mm

4.95



0701 008 100

Tafelmesser, Hohlheft
Couteau de table, manche creux

23,0/12,3 cm

9.30



0701 018 100

Vorspeisenmesser, Hohlheft
Couteau à hors-d'œuvre, manche creux

20,5/11,0 cm

9.15



72611-67

Limolöffel
Cuillère à limonade

18,1 cm / Ø 2 mm

3.95

BEARD®
SOLUTIONS HORECA

sahara

Edelstahl 18/0, satiniert
Acier inoxydable 18/0, satinée72565-04
Menulöffel
Cuillère à menu
18,7 cm / Ø 2,5 mm
2.2572565-36
Kaffeelöffel
Cuillère à café
13,7 cm / Ø 1,8 mm
1.3072565-09
Menugabel
Fourchette à menu
18,7 cm / Ø 2,5 mm
2.2572565-37
Espressoelöffel
Cuillère à espresso
12,2 cm / Ø 1,8 mm
1.2572565-12
Menumesser
Couteau à menu
20,2/9 cm
2.65



GÖFFEL und MEGALÖ – zwei Besteckteile, die zum Hit bei jedem Stehbuffet werden!

Gabel und Löffel (GÖFFEL) sowie Messer (MEGALÖ) vereinen sich zu einem einzigen Besteckteil und sind dank ihrer Flexibilität (fast) überall einsetzbar. Überraschen Sie Ihre Gäste! Sie werden begeistert sein - es macht Spass, mit diesen originellen und nicht alltäglichen Besteckteilen zu essen!

FOUILLÈRE et COUFOUILLÈRE – deux couverts qui deviendront le hit de chaque buffet cocktail!

Fourchette et cuillère (FOUILLÈRE) et couteau (COUFOUILLÈRE) sont réunis en un seul couvert qui, grâce à sa fonctionnalité, est utilisable (presque) partout. Surprenez vos convives! Ils seront enthousiasmés – quel plaisir de manger avec ces couverts qui sortent de l'ordinaire!



accessoires



Appetizergabel
Fourchette appetizer
«Zazu»

11,2 cm
0967 023 100   1.15



Göffel
Fouillère

17,3 cm / Ø 3,5 mm
155 996 100   3.75



Appetizergabel
Fourchette appetizer
«Zazu long»

15 cm
0967 024 100   1.95



Göffel (mini)
Fouillère (mini)

14,0 cm / Ø 2,7 mm
155 996 200   2.65



Appetizergabel
Fourchette appetizer
«Nordic»

14,2 cm / Ø 2 mm
0956 023 200   1.05



Megalö
Coufouillère

19,5 cm / Ø 2,5 mm
155 998 100   4.95



Appetizergabel
Fourchette appetizer
«Baguette»

13,1 cm
0120 023 100   1.70



Limolöffel
Cuillère à limonade
«Feelings»

19,2 cm / Ø 3,5 mm
0670 027 110   3.50



Appetizergabel
Fourchette appetizer

11,4 cm / Ø 2 mm
0966 023 200   1.05



Kaffelöffel
Cuillère à café
«Feelings»

13,7 cm / Ø 3,5 mm
0670 037 110   2.95



Espressolöffel
Cuillère à espresso
«Feelings»

10,4 cm / Ø 3 mm
0670 040 110   2.50





Steakmesser Hohlheft
Couteau à steak manche creux
«Prestige»

23,5/12,9 cm
0264 016 100   9.30



Steakmesser, Pakka-Holz
Couteau à steak, bois pakka
«Pakka»

22,8/10,6 cm
150321106   13.25



Steakgabel Hohlheft
Fourchette de table à steak manche creux
«Prestige»

23,7 cm
0264 017 100   6.95



Steakmesser, Pakka-Holz schwarz
Couteau à steak, bois pakka noir
«Pakka»

22,8/10,6 cm
150331101   13.25



Steakmesser Hohlheft
Couteau de table manche creux
«Primera»

24,5/12,3 cm
0380 016 100   9.30



Steakmesser, Olivenholz-Griff
Couteau à steak, manche olivier
«Mirage les essences»

23 cm
19233848100   52.90



Steakmesser, Hohlheft
Couteau à steak, manche creux

21,8/10,4 cm
8002.90600   15.55



Steakmesser, Picana-Griff
Couteau à steak, manche picana
«Mirage les essences»

23 cm
19233853100   52.90





Steakmesser, Mono
Couteau à steak, mono

23,5/11,5 cm
8002.90601   4.75



Steakmesser, Ebenholz-Griff
Couteau à steak, manche ébène
«Mirage les essences»

23 cm
19233851100   52.90



Steakmesser
Couteau à steak

25,6 cm
52552-01   34.60



Steakmesser, Griff aus Ahornholz
Couteau à steak, manche en bois d'érable

24,2 cm
52578W01   42.60



Steakmesser Profi
Couteau à steak profi

22,7/11,9 cm
8002.90400   5.70

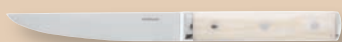

Steakmesser, Harz-Griff mit Elfenbein-Effekt
Couteau à steak, manche en résiné effet ivoire

24,2 cm
52578I01   45.30





Steakmesser
Couteau à steak
«Backen»

21,3/11,5 cm
8002.65050   6.65



Steakmesser, ohne Wellenschliff
Couteau à steak, sans tranchant denté
VICTORINOX «SwissClassic»

25/12,7 cm
8006.80460   21.15





Steakmesser, Wellenschliff
Couteau à steak, tranchant denté

22,7/11,9 cm
8002.90025   11.15



Steakmesser, ohne Wellenschliff
Couteau à steak, sans tranchant denté
VICTORINOX «Gourmet»

23,2/12 cm
8002.90020   9.05





Steakmesser, ohne Wellenschliff
Couteau à steak, sans tranchant denté

24/11,5 cm
8002.90028   16.50





Pizza-/Steakmesser, Wellenschliff
Couteau à pizza/steak, tranchant denté
VICTORINOX «Gourmet»

23,2/12 cm
8002.90021   9.05



Steakmesser, geschmiedet
Couteau à steak, forgés
VICTORINOX «Grand Maître»

24,5/12 cm
8006.80712   92.80

accessoires



Universal-Fischmesser
Couteau à poisson universel
«Pescado»

22,8 cm / Ø 4 mm

0355 028 100   5.30



Universal-Fischgabel
Fourchette à poisson universel
«Pescado»

19,8 cm / Ø 4 mm

0355 029 100   5.30



Universal-Gourmetlöffel
Cuillère gourmet universel
«Pescado»

19,6 cm / Ø 4 mm

0355 026 100   5.30



Butterstreicher Mono
Couteau à beurre mono
«Primera»

17,5/6,4 cm

0380 088 100   5.05



Butterstreicher Hohlheft
Couteau à beurre manche creux
«Classic Baguette»

17,5/6,9 cm

0120 089 100   6.95



Butterstreicher Hohlheft
Couteau à beurre manche creux
«Filet Classic»

18,6/9,4 cm

0118 088 100   8.65



Käsemesser Set 3 teilig, Hohlheft
Set de couteaux à fromage, manche creux
«Savoy»

0189 099 100

  37.95



Käsemesser Weichkäse, Hohlheft
Couteau à fromage pâte molle, manche creux
«Savoy»

23,2/12,4 cm

0189 099 110   12.65



Käsemesser Hartkäse, Hohlheft
Couteau à fromage pâte dure, manche creux
«Savoy»

21,9/11,1 cm

0189 099 120   12.65



Käsebeil, Hohlheft
Trancheur à fromage manche creux
«Savoy»

21,2/10,5 cm

0189 099 130   12.65



Party-Löffel
Cuiller à party

12,5 cm

12.8993.6040   6.75



Zakouskilöffel, Gold-Look
Cuillère à zakouskis, regard d'or

12 cm

8582.00691   7.95



Zakouskilöffel, Kupfer-Look
Cuillère à zakouskis, regard de cuivre

12 cm

8582.00692   7.95



Ess-Stäbchen, 10 Paar
Baguettes, 10 paires

25,7 cm

56541-05

78.50



Hummergabel
Fourchette à homard

24 cm

12.8336.6041

6.60



Ess-Stäbchen Ablage
Pose baguettes

9 x 2,5 cm

56541-00

11.70



Hummerzange
Pince à homard

19,8 cm

12.8410.6040

93.95



Essstäbchen (Paar)
Baguettes (paire)

22 cm

0988 055 211

24.00



Schneckengabel
Fourchette à escargots

14,5 cm

12.8335.6040

3.50



Essstäbchen-Ablage
Porte-baguettes

4 cm

0988 054 211

4.95



Schneckenzange
Pince à escargots

15 cm

12.8291.6040

16.50



Kaviarlöffel perlmutt
Cuillère à caviar nacré

11,4 cm

41518-00

26.40



Austerngabel
Fourchette à huîtres
«Contour»

13,6 cm

12.0240.6040

3.95



Kaviarspatel perlmutt
Spatule à caviar nacré

10,2 cm

41518-01

39.80



Kaffeelöffel, 18/0, 24er Set
Cuillère à café, 18/0, Set à 24
«Ecoline»

13,1 cm / Ø 1,25 mm

0399037200024

12.45/Set

(0.52 p.pc)

top
price



Kaviargabel perlmutt
Fourchette à caviar nacré

11,4 cm

41518-02

34.60



Espressolöffel, 18/0, 24er Set
Cuillère à espresso, 18/0, Set à 24
«Ecoline»

10,9 cm / Ø 1,25 mm

0399040200024

10.80/Set

(0.45 p.pc)

top
price

little world

bambino

Kinderlöffel**Cuillère pour enfant**

0291201100 Nicro/nicro 18/10 4.20

Kindergabel**Fourchette pour enfant**

0291202100 Nicro/nicro 18/10 4.20

Kindermesser Mono**Couteau pour enfant mono**

0291203100 Nicro/nicro 18/10 5.30

Kinderkaffeelöffel**Cuillère à café pour enfant**

0291204100 Nicro/nicro 18/10 2.65



carino

Kinderlöffel**Cuillère pour enfant**

0291301100 Nicro/nicro 18/10 4.95

Kindergabel**Fourchette pour enfant**

0291302100 Nicro/nicro 18/10 4.95

Kindermesser Mono**Couteau pour enfant mono**

0291303100 Nicro/nicro 18/10 4.95

Kinderkaffeelöffel**Cuillère à café pour enfant**

0291304100 Nicro/nicro 18/10 3.95





selena

Kinderlöffel**Cuillère pour enfant**

0292101100 Nicro/nicro 18/10 3.95

Kindergabel**Fourchette pour enfant**

0292102100 Nicro/nicro 18/10 3.95

Kindermesser Mono**Couteau pour enfant mono**

0292103100 Nicro/nicro 18/10 4.75

Kinderkaffeelöffel**Cuillère à café pour enfant**

0292137100 Nicro/nicro 18/10 2.50



smartie

Kinderlöffel**Cuillère pour enfant**

0430101100 Nicro/nicro 18/10 3.95

Kindergabel**Fourchette pour enfant**

0430102100 Nicro/nicro 18/10 3.95

Kindermesser Mono**Couteau pour enfant mono**

0430103100 Nicro/nicro 18/10 4.95

Kinderkaffeelöffel**Cuillère à café pour enfant**

0430104100 Nicro/nicro 18/10 2.50



little world

little sweeties

Kinderlöffel**Cuillère pour enfant**

0292201100 Nicro/nicro 18/10 6.60

Kindergabel**Fourchette pour enfant**

0292202100 Nicro/nicro 18/10 6.60

Kindermesser Mono**Couteau pour enfant mono**

0292203100 Nicro/nicro 18/10 7.95

Kinderkaffeeelöffel**Cuillère à café pour enfant**

0292204100 Nicro/nicro 18/10 5.30



little sweeties

**Becher, 6er Set****Gobelet, set à 6**

7086.00300 23,5 cl / Ø 6,5 x H 12,2 cm 15.60

(2.60 p.pc)



Die neue Kinderserie von Berndorf Luzern

little world

nimmt die Kinder mit auf eine Fantastische Reise durch 4 Zauberwelten.

Die gesamte Linie besteht aus 4 Sujets, welche Berndorf eigens für sich entwickeln liess. Alle 4 Charaktere leben in ihrer eigenen kleinen Welt in welcher es für die Kinder viel zu entdecken gibt. Da kommt auch am Esstisch garantiert keine Langeweile auf!

Ella – die lustige, freche Fee
 Lisa – die liebe, kecke Prinzessin
 Moritz – der verwegene, abenteuerlustige Pirat
 Sam – der clevere Denker als Astronaut

La nouvelle gamme de Berndorf Lucerne

little world

emmène les enfants sur un voyage à incroyable travers quatres mondes magiques.

Toute la gamme se compose de 4 sujets, que Berndorf a laissés développé spécifiquement pour eux-mêmes. Les 4 personnages vivent dans leur propre petit monde dans lequel il ya beaucoup à découvrir pour les enfants. Il ya alors aucune chance de l'ennui à table!

Ella - le drôle, impertinent de fées
 Lisa – la gentil, la princesse coquine
 Moritz - l'audace, pirate aventureux
 Sam - le penseur intelligent comme astronaute



Teller Porzellan
 Assiette porcelaine

Littleworld900 Ø 25,5 cm

34.90

Bébételler Porzellan
 Assiette de bébé porcelaine

bebe900 Ø 17 cm

31.95



Tischset zum Ausmalen und Spielen 40 Stk.
 Sets de table pour coloriage et pour jouer 40 pcs.

block700 41 x 30 cm

CHF 8.50





Glas | Verre

Zalto
GLASMANUFAKTUR



Mundgeblasen
Soufflé bouche



denk'art

FEINGEFÜHL

Schon beim Berühren unterscheiden sich die Meisterstücke von Zalto von allen anderen Gläsern. Was sofort auffällt, ist die ausgewogene Balance – die Gläser erscheinen zart und elegant.

HANDWERKSKUNST

Perfektion ist der Grundsatz der Zalto Glasmanufaktur. Durch das filigrane Design der Gläser wird das Geschick der Glasbläser aufs Äußerste gefordert. Die Handarbeit erinnert an die hohe Kunstfertigkeit venezianischer Glaskünstler der Renaissance.

MUNDGEBLASEN

Die Glastradition im nördlichen Waldviertel geht bis ins frühe 14. Jahrhundert zurück. Seitdem wird in dieser Region hochwertiges, mundgeblasenes Glas produziert, das sich bis weit über die Grenzen des Landes hinaus einen Namen gemacht hat.

FINESSE

Par le toucher déjà, les chefs-d'oeuvre de Zalto se différencient de tous les autres verres. On peut tout de suite remarquer l'équilibre parfait – les verres sont délicats et élégants.

ART ARTISANAL

Le principe de la verrerie Zalto repose sur la perfection. Le design en filigrane des verres demande une habileté extrême de la part des souffleurs de verres. Ce travail fait main rappelle la virtuosité des artistes vénitiens de la renaissance.

SOUFFLÉ BOUCHE

Dans cette région septentrionale, la tradition du verre remonte au début du 14ème siècle. Depuis lors, du verre soufflé bouche y est produit, lequel a acquis une notoriété bien au-delà des frontières du pays.















Gravitas Omega 90 cl / H 230 mm Max Ø 125 mm Top Ø 70 mm	Burgunder Bourgogne 90 cl / H 230 mm Max Ø 125 mm Top Ø 70 mm	Bordeaux Bordeaux 74 cl / H 240 mm Max Ø 108 mm Top Ø 74 mm	Universal Universel 53 cl / H 235 mm Max Ø 90 mm Top Ø 67 mm	Weisswein Vin blanc 40 cl / H 230 mm Max Ø 81 mm Top Ø 59 mm	Süsswein Vin doux 28 cl / H 230 mm Max Ø 83 mm Top Ø 60 mm
740090100 46.60 	740111000 43.95 	740112000 42.60 	740113000 39.95 	740114000 38.50 	740116000 38.50
Champagner Champagne 25 cl / H 240 mm Max Ø 70 mm Top Ø 56 mm	Champagner Champagne 25 cl / H 240 mm Max Ø 70 mm Top Ø 56 mm - 1 cl	Digestif Digestif 14 cl / H 210 mm Max Ø 54 mm Top Ø 43 mm	Digestif Digestif 14 cl / H 210 mm Max Ø 54 mm Top Ø 43 mm - 2+4 cl	Bier Bière 36 cl / H 223 mm Max Ø 70 mm Top Ø 53 mm	Wasser Eau 42 cl / H 195 mm Max Ø 82 mm Top Ø 59 mm
740115500 39.95 	740115510 41.95 	740117000 33.30 	740117108 34.25 	740118000 38.50 	740118500 38.50
Becher klar Gobelet claire 37 cl / H 98 mm Max Ø 91 mm Top Ø 91 mm	Becher effekt Gobelet effet 37 cl / H 98 mm Max Ø 91 mm Top Ø 91 mm	No25 35 cl / H 175 mm	No75 82 cl / H 248 mm	Axiom 145 cl / H 204 mm	Mystique 190 cl / H 185 mm
740270100 26.45 	740270110 26.45 	740011911 39.80 	740011921 55.25 	740011961 82.10 	740011970 97.60

! Eingeschränkte Robustheit
robustesse limitée

**Mundgeblasen**
Soufflé bouche**vinoble**













Vinoble

					
Weinkelch Verre à vin 43 cl / H 240 mm Ø 92/64 mm	Weinkelch Verre à vin 66 cl / H 255 mm Ø 105/71 mm	Weinkelch Verre à vin 75 cl / H 255 mm Ø 113/78 mm	Sektkelch Flûte 30 cl / H 260 mm Ø 73/49 mm	Sektkelch Flûte 30 cl / H 260 mm Ø 73/49 mm - 1 dl	
740601000 25.30	740602000 26.50	740603000 29.30	740605000 25.30	740605010 26.60	
 	 	 	 	 	

! Eingeschränkte Robustheit
robustesse limitée



sensus

					—
Weinkelch Verre à vin 38,6 cl / H 236 mm Max Ø 82,5 mm Top Ø 60 mm	Weinkelch Verre à vin 50,2 cl / H 240 mm Max Ø 90 mm Top Ø 66 mm	Weinkelch Verre à vin 68,5 cl / H 245 mm Max Ø 108 mm Top Ø 74 mm	Sektkelch Flûte 26,1 cl / H 245 mm Max Ø 68 mm Top Ø 52 mm	Sektkelch Flûte 26,1 cl / H 245 mm Max Ø 68 mm Top Ø 52 mm	— 1 dl
741001001 8.65	741001002 9.05	741001003 9.30	741001004 8.65	741001010 9.95	
					



cultus

						—
Weinkelch Verre à vin 36 cl / H 225 mm Max Ø 80 mm Top Ø 57 mm	Weinkelch Verre à vin 47 cl / H 240 mm Max Ø 93 mm Top Ø 67 mm	Weinkelch Verre à vin 66 cl / H 253 mm Max Ø 99 mm Top Ø 68 mm	Weinkelch Verre à vin 86 cl / H 256 mm Max Ø 122 mm Top Ø 72 mm	Sektkelch Flûte 21 cl / H 263 mm Max Ø 66 mm Top Ø 42 mm	Sektkelch Flûte 21 cl / H 263 mm Max Ø 66 mm Top Ø 42 mm	— 1 dl
743001000 7.95	743002000 8.75	743003000 8.95	743004000 8.95	743005000 7.95	743005010 9.30	
						



grand cru



|—|

Weinkelch
Verre à vin
75 cl / H 230 mm
Max Ø 106 mm
Top Ø 73 mm

Weinkelch
Verre à vin
78 cl / H 240 mm
Max Ø 93 mm
Top Ø 67 mm

Weinkelch
Verre à vin
49,5 cl / H 230 mm
Max Ø 85 mm
Top Ø 61 mm

Weinkelch
Verre à vin
36,5 cl / H 215 mm
Max Ø 76 mm
Top Ø 55 mm

Sektkelch
Flûte
18 cl / H 220 mm
Max Ø 65 mm
Top Ø 43 mm

Sektkelch
Flûte
18 cl / H 220 mm
Max Ø 65 mm
Top Ø 43 mm

730500000

9.30

730502000

9.30

730501000

9.05

730503000

7.95

730504000

7.70

730504010

9.05



|—| 1 dl



weinland



Weinglas
Verre à vin
65 cl / H 205 mm
Max Ø 108 mm
Top Ø 87 mm

Weinglas
Verre à vin
66 cl / H 223 mm
Max Ø 94 mm
Top Ø 71 mm

Weinglas
Verre à vin
54 cl / H 212 mm
Max Ø 90 mm
Top Ø 67 mm

Weinglas
Verre à vin
45 cl / H 205 mm
Max Ø 85 mm
Top Ø 63 mm

Weinglas
Verre à vin
35 cl / H 195 mm
Max Ø 79 mm
Top Ø 59 mm

Weinglas
Verre à vin
29 cl / H 190 mm
Max Ø 75 mm
Top Ø 57 mm

8003.16060

6.60

8003.16070

6.60

8003.16080

6.50

8003.16000

6.35

8003.16010

6.10

8003.16020

5.30



Weinglas
Verre à vin
23 cl / H 171 mm
Max Ø 68 mm
Top Ø 54 mm

Champagner
Champagne
20 cl / H 212 mm
Max Ø 67 mm
Top Ø 44 mm

Champagner
Champagne
20 cl / H 212 mm
Max Ø 67 mm
Top Ø 44 mm

8003.16050

5.30

8003.16090

6.35





8003.16095



7.60















revolution







				
Weinglas Verre à vin 65 cl / H 240 mm Max Ø 95 mm Top Ø 67 mm	Weinglas Verre à vin 49 cl / H 225 mm Max Ø 85 mm Top Ø 61 mm	Weinglas Verre à vin 36,5 cl / H 220 mm Max Ø 78 mm Top Ø 56 mm	Champagner Champagne 20 cl / H 225 mm Max Ø 52 mm Top Ø 42 mm	Champagner Champagne 20 cl / H 225 mm Max Ø 52 mm Top Ø 42 mm - 1 dl
730533000 7.85	730530000 7.30	730531000 6.50	730532000 7.30	730532010 8.55

		
Becher Gobelet 39 cl / H 144 mm Max Ø 70 mm Top Ø 59 mm	Becher Gobelet 47 cl / H 109 mm Max Ø 92 mm Top Ø 69 mm	Becher Gobelet 37 cl / H 100 mm Max Ø 85 mm Top Ø 65 mm
730534000 5.30	730536000 5.30	730535000 5.05



power

				
Weinglas Verre à vin 52 cl / H 226 mm Max Ø 93 mm Top Ø 65 mm	Weinglas Verre à vin 40 cl / H 210 mm Max Ø 85 mm Top Ø 60 mm	Champagner Champagne 24 cl / H 226 mm Max Ø 61 mm Top Ø 46 mm	Champagner Champagne 24 cl / H 226 mm Max Ø 61 mm Top Ø 46 mm - - d	Champagner Champagne 27,6 cl / H 162 mm Max Ø 93 mm Top Ø 83 mm
730510000 9.95	730511000 9.30	730513000 9.30	730513010 10.55	730512000 9.30
				

		
Becher Gobelet 45,8 cl / H 144 mm Max Ø 78 mm Top Ø 56 mm	Becher Gobelet 50 cl / H 110 mm Max Ø 93 mm Top Ø 66 mm	Becher Gobelet 38 cl / H 101 mm Max Ø 85 mm Top Ø 60 mm
730514000 6.65	730516000 6.50	730515000 6.35
		



fino



|—|

Weinglas
Verre à vin
54,5 cl / H 240 mm
Max Ø 88 mm
Top Ø 60 mm

Weinglas
Verre à vin
45,1 cl / H 232 mm
Max Ø 81 mm
Top Ø 57 mm

Champagner
Champagne
42,5 cl / H 250 mm
Max Ø 84 mm
Top Ø 60 mm

Champagner
Champagne
42,5 cl / H 250 mm
Max Ø 84 mm
Top Ø 60 mm

730505000 11.95



730506000 11.95



730507000 11.95

|—| 1 dl
730507010 13.20

















symphony









<p>Weinglas Verre à vin 71 cl / H 245 mm Max Ø 116 mm Top Ø 68 mm</p> <p>730520000 13.25</p>	<p>Weinglas Verre à vin 64,5 cl / H 255 mm Max Ø 102 mm Top Ø 65 mm</p> <p>730524000 13.25</p>	<p>Weinglas Verre à vin 57 cl / H 250 mm Max Ø 96 mm Top Ø 61 mm</p> <p>730521000 12.90</p>	<p>Weinglas Verre à vin 40,5 cl / H 245 mm Max Ø 83 mm Top Ø 57 mm</p> <p>730522000 11.95</p>	<p>Champagner Champagne 29 cl / H 260 mm Max Ø 82 mm Top Ø 49 mm</p> <p>730523000 11.95</p>	<p>Champagner Champagne 29 cl / H 260 mm Max Ø 82 mm Top Ø 49 mm</p> <p> — 1 dl 730523010 13.20</p>
--	--	---	---	---	--



endura

				
Weinkelch Verre à vin 76 cl / H 216 mm Max Ø 113 mm Top Ø 86 mm	Weinkelch Verre à vin 58,5 cl / H 230 mm Max Ø 94 mm Top Ø 72 mm	Weinkelch Verre à vin 50 cl / H 220 mm Max Ø 88,2 mm Top Ø 68 mm	Weinkelch Verre à vin 38,5 cl / H 202 mm Max Ø 81 mm Top Ø 60 mm	Weinkelch Verre à vin 27 cl / H 180 mm Max Ø 72 mm Top Ø 55 mm
711901000 5.30	711902000 5.15	711903000 4.90	711904000 4.65	711905000 3.95
 	 	 	 	 

	
Sektkelch Flûte 18,5 cl / H 225 mm Max Ø 69 mm Top Ø 50 mm	Sektkelch Flûte 18,5 cl / H 225 mm Max Ø 69 mm Top Ø 50 mm
711906000 3.95	711906010 5.15
 	 

marquis

Echtkristall
Cristal véritable

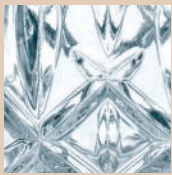

Whisky Tumbler
Whisky Tumbler
29,5 cl / H 98 mm
Max Ø 82 mm
Top Ø 82 mm

Longdrink
Longdrink
37,5 cl / H 148 mm
Max Ø 77 mm
Top Ø 77 mm

745003000 7.55
 

745004000 7.95
 



 **Nachtmann**
FINE BAVARIAN CRYSTAL
THE LIFE STYLE DIVISION OF RIEDEL GLASS WORKS



cascada



Echtkristall
Cristal véritable



Whisky Tumbler
Whisky Tumbler
33 cl / H 100 mm
Max Ø 84 mm
Top Ø 84 mm

Longdrink
Longdrink
39,5 cl / H 150 mm
Max Ø 80 mm
Top Ø 80 mm

745005000 7.55
 

745006000 7.95
 



 **Nachtmann**
FINE BAVARIAN CRYSTAL
THE LIFE STYLE DIVISION OF RIEDEL GLASS WORKS

 **Nachtmann**
FINE BAVARIAN CRYSTAL
THE LIFE STYLE DIVISION OF RIEDEL GLASS WORKS



aramis

Echtkristall
Cristal véritable



Whisky Tumbler
Whisky Tumbler
32,4 cl / H 98 mm
Max Ø 88 mm
Top Ø 88 mm

745001000



7.55



Longdrink
Longdrink
30,9 cl / H 153 mm
Max Ø 72 mm
Top Ø 72 mm

745002000

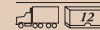

7.95

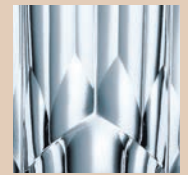

 **berndorf**
LUZERN



prestige



Becher nieder
Gobelet
20 cl / H 78 mm
Ø 71 mm

744020000



3.55



Becher nieder
Gobelet bas
35 cl / H 98 mm
Ø 78 mm

744021000

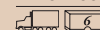

3.95



Becher hoch
Gobelet haut
35 cl / H 140 mm
Ø 66 mm

744022000



3.95



sincerus



**Cocktail
Becher
Gobelet**
25 cl / H 90 mm
Max Ø 79 mm
Top Ø 67 mm

744001000 3.15



**Cocktail
Becher
Gobelet**
25 cl / H 90 mm
Max Ø 79 mm
Top Ø 67 mm

|-| 2 dl
744001020 3.95



**Whisky
Becher
Gobelet**
36 cl / H 95 mm
Max Ø 84 mm
Top Ø 71 mm

744002000 3.30



**Whisky
Becher
Gobelet**
36 cl / H 95 mm
Max Ø 84 mm
Top Ø 71 mm

|-| 3 dl
744002030 4.10



**Whisky
Becher
Gobelet**
36 cl / H 95 mm
Max Ø 84 mm
Top Ø 71 mm

|-| 2+4 cl
744002108 4.50



**Mixdrink
Becher
Gobelet**
35 cl / H 132 mm
Max Ø 73 mm
Top Ø 62 mm

744003000 3.30



**Mixdrink
Becher
Gobelet**
35 cl / H 132 mm
Max Ø 73 mm
Top Ø 62 mm

|-| 3 dl
744003030 4.10



**Mixdrink
Becher
Gobelet**
35 cl / H 132 mm
Max Ø 73 mm
Top Ø 62 mm

|-| 2+4 cl
744003108 4.50



**Longdrink XL
Becher
Gobelet**
49 cl / H 144 mm
Max Ø 79 mm
Top Ø 66 mm

744004000 3.95



**Longdrink XL
Becher
Gobelet**
49 cl / H 144 mm
Max Ø 79 mm
Top Ø 66 mm

|-| 4 dl
744004040 4.75







alaska



**Becher
Gobelet**
58 cl / H 173 mm
Max/Top Ø 78 mm

8442.19000 3.55



**Becher
Gobelet**
58 cl / H 173 mm
Max/Top Ø 78 mm

8442.19001 4.75



**Becher
Gobelet**
47 cl / H 161 mm
Max/Top Ø 74 mm

8442.18000 3.15



**Becher
Gobelet**
47 cl / H 161 mm
Max/Top Ø 74 mm

8442.18001 4.25



**Becher
Gobelet**
37 cl / H 150 mm
Max/Top Ø 67 mm

8442.17000 2.65

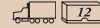

**Becher
Gobelet**
37 cl / H 150 mm
Max/Top Ø 67 mm

8442.17001 4.35



**Becher
Gobelet**
29 cl / H 140 mm
Max/Top Ø 62 mm

8442.16000 2.65



**Becher
Gobelet**
29 cl / H 140 mm
Max/Top Ø 62 mm

8442.16001 3.85



**Becher
Gobelet**
26 cl / H 123 mm
Max/Top Ø 63 mm

8442.15000 1.95



**Becher
Gobelet**
26 cl / H 123 mm
Max/Top Ø 63 mm

8442.15001 3.05



**Becher
Gobelet**
22 cl / H 89 mm
Max/Top Ø 73 mm

8442.20000 2.35



**Becher
Gobelet**
22 cl / H 89 mm
Max/Top Ø 73 mm

8442.20024 3.85





DEGRENNE
 PARIS



newport twist



Becher nieder
stapelbar
Gobelet bas
empilable
 25 cl

Karaffe
Carafe
 25 cl / H 19 cm
 Ø 4,4 cm

59242959220 26.40



59242961220 88.00





onís





gibraltar



gibraltar



**Krug
Jug**
1,8 l / H 230 mm
Max Ø 160 mm
Top Ø 160 mm
711010000 15.25
 



**Rocks
Becher
Gobelet**
21 cl / H 80 mm
Max Ø 80 mm
Top Ø 80 mm
710309000 1.95
 



**Rocks
Becher
Gobelet**
27 cl / H 90 mm
Max Ø 85 mm
Top Ø 85 mm
710310000 2.10
 



**Double Rocks
Becher
Gobelet**
35,5 cl / H 99 mm
Max Ø 90 mm
Top Ø 90 mm
710322000 2.30
 



**Hi-Ball
Becher
Gobelet**
20,7 cl / H 115 mm
Max Ø 67 mm
Top Ø 67 mm
710307000 1.95
 







**Hi-Ball
Becher
Gobelet**
26,6 cl / H 118 mm
Max Ø 78 mm
Top Ø 78 mm
710304000 2.30
 

**Beverage
Becher
Gobelet**
35,5 cl / H 121 mm
Max Ø 85 mm
Top Ø 85 mm
710306000 2.30
 

**Beverage
Becher
Gobelet**
41,4 cl / H 129 mm
Max Ø 89 mm
Top Ø 89 mm
710327000 2.50
 

**Cooler
Becher
Gobelet**
35,5 cl / H 149 mm
Max Ø 79 mm
Top Ø 79 mm
710303000 2.30
 



**Cooler
Becher
Gobelet**
35,5 cl / H 149 mm
Max Ø 79 mm
Top Ø 79 mm
|-| 2+4 cl
710303108 3.10
 



**Cooler
Becher
Gobelet**
35,5 cl / H 149 mm
Max Ø 79 mm
Top Ø 79 mm
|-| 3 dl
710303030 3.10
 

ARCOROC



ARCOROC





**Cooler
Becher
Gobelet**
47,3 cl / H 161 mm
Max Ø 85 mm
Top Ø 85 mm
710319000 2.90
 

**Cooler
Becher
Gobelet**
47,3 cl / H 161 mm
Max Ø 85 mm
Top Ø 85 mm
|-| 4 dl
710319040 3.70
 

Dazu passend
En complément

**Cooler
Becher
Gobelet**
65 cl / H 178 mm
Max Ø 96 mm
Top Ø 96 mm
1500.43013 4.35
 

**Cooler
Becher
Gobelet**
65 cl / H 178 mm
Max Ø 96 mm
Top Ø 96 mm
|-| 5 dl
1500.43165 5.30
 

onis

Bärenstark
très robuste

paneled tumblers



|—|



|—|



**Juice
Becher
Gobelet**
25 cl / H 103 mm
Max Ø 76 mm
Top Ø 76 mm

710642000 2.25



**Juice
Becher
Gobelet**
25 cl / H 103 mm
Max Ø 76 mm
Top Ø 76 mm

710642020 3.05



**Tumbler
Becher
Gobelet**
35 cl / H 138 mm
Max Ø 78 mm
Top Ø 78 mm

710640000 2.50



**Tumbler
Becher
Gobelet**
35 cl / H 138 mm
Max Ø 78 mm
Top Ø 78 mm

710640030 3.30









**Cooler
Becher
Gobelet**
47 cl / H 155 mm
Max Ø 84 mm
Top Ø 84 mm













710641000 2.90





lexington

		
Juice Becher Gobelet 14,8 cl / H 89 mm Max Ø 57 mm Top Ø 57 mm	Juice Becher Gobelet 14,8 cl / H 89 mm Max Ø 57 mm Top Ø 57 mm	Old Fashioned Becher Gobelet 22,9 cl / H 89 mm Max Ø 73 mm Top Ø 73 mm
710208000 2.50	710208010 3.40	710205000 2.65
		

					
Hi-Ball Becher Gobelet 26,6 cl / H 121 mm Max Ø 64 mm Top Ø 64 mm	Hi-Ball Becher Gobelet 26,6 cl / H 121 mm Max Ø 64 mm Top Ø 64 mm	Hi-Ball Becher Gobelet 26,6 cl / H 121 mm Max Ø 64 mm Top Ø 64 mm	Tall Hi-Ball Becher Gobelet 31,1 cl / H 150 mm Max Ø 64 mm Top Ø 64 mm	Tall Hi-Ball Becher Gobelet 31,1 cl / H 150 mm Max Ø 64 mm Top Ø 64 mm	Jigger Becher Gobelet 8,9 cl / H 66 mm Max Ø 51 mm Top Ø 51 mm
710204000 2.90	710204108 3.80	710204020 3.80	710201000 3.15	710201108 4.05	710200000 1.95
					

onís



everest



**Rocks
Becher
Gobelet**

14,5 cl / H 75 mm
Max Ø 72 mm
Top Ø 72 mm

710616000

2.90



**Rocks
Becher
Gobelet**

20,5 cl / H 85 mm
Max Ø 78 mm
Top Ø 78 mm

710617000

3.15



**Rocks
Becher
Gobelet**

26,5 cl / H 95 mm
Max Ø 84 mm
Top Ø 84 mm

710618000

3.45



**Beverage
Becher
Gobelet**

35,5 cl / H 117 mm
Max Ø 84 mm
Top Ø 84 mm

710619000

3.85



**Beverage
Becher
Gobelet**

41,5 cl / H 121 mm
Max Ø 86 mm
Top Ø 86 mm

710615000

5.30





endeavor

Rocks Becher Gobelet 20,7 cl / H 92 mm Max Ø 82 mm Top Ø 82 mm	Rocks Becher Gobelet 26,6 cl / H 98 mm Max Ø 89 mm Top Ø 89 mm	D.O.F. Becher Gobelet 35,5 cl / H 105 mm Max Ø 98 mm Top Ø 98 mm	Hi-Ball Becher Gobelet 29,6 cl / H 158 mm Max Ø 70 mm Top Ø 70 mm	Beverage Becher Gobelet 35,5 cl / H 158 mm Max Ø 76 mm Top Ø 76 mm
711143000 3.05	711144000 3.30	711145000 3.55	711146000 3.45	711147000 3.55



on's



carats





«DOF»
Becher
Gobelet
35,5 cl x H 107 mm
Ø 89 mm

711794000 6.10
  12



«Cooler»
Becher
Gobelet
47,3 cl / H 154 mm
Ø 78 mm

711795000 6.10
  12



on's



radiant





«DOF»
Becher
Gobelet
35 cl x H 106 mm
Ø 89 mm

711876000 6.50
  12



«Cooler»
Becher
Gobelet
47 cl / H 157 mm
Ø 85 mm

711875000 6.50
  12

on's



hobstar



«DOF»
Becher
Gobelet
35 cl / H 106 mm
Ø 89 mm

711796000

6.10



Hi-Ball
Becher
Gobelet
35,5 cl / H 144 mm
Ø 77,5 mm

711885000

6.10



«Cooler»
Becher
Gobelet
47,5 cl / H 157 mm
Ø 84 mm

711797000

6.35



«Shot»
Becher
Gobelet
6 cl / H 61 mm
Ø 50 mm

711798000

3.55



onís



hobstar colored

spring/summer collection



«DOF»
Becher
Gobelet
tender taupe
35 cl / H 106 mm
Ø 89 mm

711796001

6.10



«DOF»
Becher
Gobelet
pale yellow
35 cl / H 106 mm
Ø 89 mm

711796002

6.10



«DOF»
Becher
Gobelet
ebony green
35 cl / H 106 mm
Ø 89 mm

711796003

6.10



«DOF»
Becher
Gobelet
coral pink
35 cl / H 106 mm
Ø 89 mm

711796004

6.10



«DOF»
Becher
Gobelet
charm lavender
35 cl / H 106 mm
Ø 89 mm

711796005

6.10



«DOF»
Becher
Gobelet
sky blue
35 cl / H 106 mm
Ø 89 mm

711796006

6.10



autumn/winter collection



«DOF»
Becher
Gobelet
ocher
35 cl / H 106 mm
Ø 89 mm

711796011

6.10



«DOF»
Becher
Gobelet
rose
35 cl / H 106 mm
Ø 89 mm

711796012

6.10



«DOF»
Becher
Gobelet
grey
35 cl / H 106 mm
Ø 89 mm

711796013

6.10



«DOF»
Becher
Gobelet
green
35 cl / H 106 mm
Ø 89 mm

711796014

6.10



«DOF»
Becher
Gobelet
blue
35 cl / H 106 mm
Ø 89 mm

711796015

6.10







black hobstar



«DOF»
Becher
Gobelet
35 cl / H 106 mm
Ø 89 mm

«Cooler»
Becher
Gobelet
47,5 cl / H 157 mm
Ø 84 mm

711796100 9.30
 

711797100 9.95
 





soho







Longdrink
Becher
Gobelet
40,5 cl / H 165 mm
Ø 66 mm

Longdrink
Becher
Gobelet
38 cl / H 155 mm
Ø 65 mm

Whisky
Becher
Gobelet
32 cl / H H 94 mm
Ø 80 mm

730541000 9.30
 

730540000 9.05
 

730542000 9.05
 





twister



Becher bernstein
Gobelet ambre
46,5 cl / H 120 mm
Max Ø 85 mm
Top Ø 60 mm

730548000

9.30



Becher flieder
Gobelet lilas
46,5 cl / H 120 mm
Max Ø 85 mm
Top Ø 60 mm

730547000

9.30



Becher blaugrau
Gobelet gris-bleu
46,5 cl / H 120 mm
Max Ø 85 mm
Top Ø 60 mm

730549000

9.30



Becher grün
Gobelet vert
46,5 cl / H 120 mm
Max Ø 85 mm
Top Ø 60 mm

730545000

9.30



Becher braun
Gobelet marron
46,5 cl / H 120 mm
Max Ø 85 mm
Top Ø 60 mm

730546000

9.30



Becher rauchgrau
Gobelet gris fumé
46,5 cl / H 120 mm
Max Ø 85 mm
Top Ø 60 mm

730550000

9.30





zafferano



perle



Becher Gobelet
Aquamarine
32 cl / H 109 mm
Ø 71 mm

Becher Gobelet
Amber
32 cl / H 109 mm
Ø 71 mm



Becher Gobelet
Amethyst
32 cl / H 109 mm
Ø 71 mm

Becher Gobelet
Grey
32 cl / H 109 mm
Ø 71 mm

Becher Gobelet
Red
32 cl / H 109 mm
Ø 71 mm



Becher Gobelet
Green
32 cl / H 109 mm
Ø 71 mm

745030000 19.85
 

745031000 19.85
 

745032000 19.85
 

745033000 19.85
 

745034000 19.85
 

745035000 19.85
 



isole



«Jamaica»
Becher
Gobelet

33 cl / H 108 mm
Ø 78 mm

745101000

15.95



«Galapagos»
Becher
Gobelet

33 cl / H 108 mm
Ø 78 mm

745102000

15.95



«Capri»
Becher
Gobelet

33 cl / H 108 mm
Ø 78 mm

745103000

15.95



«Mykonos»
Becher
Gobelet

33 cl / H 108 mm
Ø 78 mm

745104000

15.95



- Becher sind mundgeblasen
- Individuell gefertigt durch Handarbeit
- Masse können leicht voneinander abweichen
- Durchgefärbtes Glas
- Spülmaschinenfest

- Gobelets soufflés à la bouche
- Fabriqués individuellement à la main
- Quelques légères différences peuvent apparaître dans la forme
- Verre teinté dans la masse
- Lavable au lave-vaisselle



zante



**Becher
Gobelet**
Amber/Amber
33 cl / H 110 mm
Ø 75 mm

**Becher
Gobelet**
Pflaume/Prune
33 cl / H 110 mm
Ø 75 mm

**Becher
Gobelet**
Braun/Brun
33 cl / H 110 mm
Ø 75 mm

**Becher
Gobelet**
Blau/Bleu
33 cl / H 110 mm
Ø 75 mm

**Becher
Gobelet**
Hellblau/Bleu clair
33 cl / H 110 mm
Ø 75 mm

**Becher
Gobelet**
Grau/Gris
33 cl / H 110 mm
Ø 75 mm

745110000

13.25

745111000

13.25

745112000

13.25

745114000

13.25

745115000

13.25

745116000

13.25



**Becher
Gobelet**
Klar/Transparent
33 cl / H 110 mm
Ø 75 mm

745113000

13.25



- Becher sind mundgeblasen
- Individuell gefertigt durch Handarbeit
- Masse können leicht voneinander abweichen
- Durchgefärbtes Glas
- Spülmaschinenfest

- Gobelets soufflés à la bouche
- Fabriqués individuellement à la main
- Quelques légères différences peuvent apparaître dans la forme
- Verre teinté dans la masse
- Lavable au lave-vaisselle



samoa



Becher gross
Gobelet grand
Klar/Transparent
30 cl / H 104 mm
Ø 90 mm

745058000 9.85



Becher klein
Gobelet petit
Klar/Transparent
25 cl / H 94 mm
Ø 86 mm

745078000 9.30



Becher gross
Gobelet grand
Weiss/Blanc
30 cl / H 104 mm
Ø 90 mm

745059000 9.85



Becher klein
Gobelet petit
Weiss/Blanc
25 cl / H 94 mm
Ø 86 mm

745079000 9.30



Becher gross
Gobelet grand
Schwarz/Noir
30 cl / H 104 mm
Ø 90 mm

745050000 9.85



Becher klein
Gobelet petit
Schwarz/Noir
25 cl / H 94 mm
Ø 86 mm

745070000 9.30



Becher gross
Gobelet grand
Türkis/Turquoise
30 cl / H 104 mm
Ø 90 mm

745051000 9.85



Becher klein
Gobelet petit
Türkis/Turquoise
25 cl / H 94 mm
Ø 86 mm

745071000 9.30



Becher gross
Gobelet grand
Königsblau/Bleu roi
30 cl / H 104 mm
Ø 90 mm

745052000 9.85



Becher klein
Gobelet petit
Königsblau/Bleu roi
25 cl / H 94 mm
Ø 86 mm

745072000 9.30



Becher gross
Gobelet grand
Marineblau/Bleu marine
30 cl / H 104 mm
Ø 90 mm

745053000 9.85



Becher klein
Gobelet petit
Marineblau/Bleu marine
25 cl / H 94 mm
Ø 86 mm

745073000 9.30



Becher gross
Gobelet grand
Hellblau/Bleu clair
30 cl / H 104 mm
Ø 90 mm

745054000 9.85



Becher klein
Gobelet petit
Hellblau/Bleu clair
25 cl / H 94 mm
Ø 86 mm

745074000 9.30



Becher gross
Gobelet grand
Aqua/Aqua
30 cl / H 104 mm
Ø 90 mm

745055000 9.85



Becher klein
Gobelet petit
Aqua/Aqua
25 cl / H 94 mm
Ø 86 mm

745075000 9.30



Becher gross
Gobelet grand
Lavendel/Lavande
30 cl / H 104 mm
Ø 90 mm

745056000 9.85



Becher klein
Gobelet petit
Lavendel/Lavande
25 cl / H 94 mm
Ø 86 mm

745076000 9.30



- Becher sind mundgeblasen
- Individuell gefertigt durch Handarbeit
- Masse können leicht voneinander abweichen
- Durchgefärbtes Glas
- Spülmaschinenfest
- Stapeln wird nicht empfohlen
- Gobelets soufflés à la bouche
- Fabriqués individuellement à la main
- Quelques légères différences peuvent apparaître dans la forme
- Verre teinté dans la masse
- Lavable au lave-vaisselle
- Ne pas empiler les gobelets



Becher gross
Gobelet grand
Violett/Violet
30 cl / H 104 mm
Ø 90 mm
745061000 9.85

Becher klein
Gobelet petit
Violett/Violet
25 cl / H 94 mm
Ø 86 mm
745081000 9.30

Becher gross
Gobelet grand
Pflaume/Prune
30 cl / H 104 mm
Ø 90 mm
745062000 9.85

Becher klein
Gobelet petit
Pflaume/Prune
25 cl / H 94 mm
Ø 86 mm
745082000 9.30

Becher gross
Gobelet grand
Rosa/Rosé
30 cl / H 104 mm
Ø 90 mm
745120000 9.85

Becher klein
Gobelet petit
Rosa/Rosé
25 cl / H 94 mm
Ø 86 mm
745121000 9.30



Becher gross
Gobelet grand
Rot/Rouge
30 cl / H 104 mm
Ø 90 mm
745069000 9.85

Becher klein
Gobelet petit
Rot/Rouge
25 cl / H 94 mm
Ø 86 mm
745089000 9.30

Becher gross
Gobelet grand
Mandarin/Mandarin
30 cl / H 104 mm
Ø 90 mm
745068000 9.85

Becher klein
Gobelet petit
Mandarin/Mandarin
25 cl / H 94 mm
Ø 86 mm
745088000 9.30

Becher gross
Gobelet grand
Orange/Orange
30 cl / H 104 mm
Ø 90 mm
745067000 9.85

Becher klein
Gobelet petit
Orange/Orange
25 cl / H 94 mm
Ø 86 mm
745087000 9.30



Becher gross
Gobelet grand
Amber/Amber
30 cl / H 104 mm
Ø 90 mm
745066000 9.85

Becher klein
Gobelet petit
Amber/Amber
25 cl / H 94 mm
Ø 86 mm
745086000 9.30

Becher gross
Gobelet grand
Gelb/Jaune
30 cl / H 104 mm
Ø 90 mm
745065000 9.85

Becher klein
Gobelet petit
Gelb/Jaune
25 cl / H 94 mm
Ø 86 mm
745085000 9.30

Becher gross
Gobelet grand
Hellgrün/Vert clair
30 cl / H 104 mm
Ø 90 mm
745064000 9.85

Becher klein
Gobelet petit
Hellgrün/Vert clair
25 cl / H 94 mm
Ø 86 mm
745084000 9.30



Becher gross
Gobelet grand
Dunkelgrün/Vert foncé
30 cl / H 104 mm
Ø 90 mm
745060000 9.85

Becher klein
Gobelet petit
Dunkelgrün/Vert foncé
25 cl / H 94 mm
Ø 86 mm
745080000 9.30

Becher gross
Gobelet grand
Olivgrün/Vert olive
30 cl / H 104 mm
Ø 90 mm
745063000 9.85

Becher klein
Gobelet petit
Olivgrün/Vert olive
25 cl / H 94 mm
Ø 86 mm
745083000 9.30

Becher gross
Gobelet grand
Rauchgrau/Gris fumé
30 cl / H 104 mm
Ø 90 mm
745057000 9.85



Becher klein
Gobelet petit
Rauchgrau/Gris fumé
25 cl / H 94 mm
Ø 86 mm
745077000 9.30



cannes





**Becher
Gobelet**
azurblau/bleu azur
31 cl / H 100 mm
Ø 90 mm

745090000 7.30
 





**Becher
Gobelet**
türkis/turquoise
31 cl / H 100 mm
Ø 90 mm

745091000 7.30
 





**Becher
Gobelet**
pflaume/prune
31 cl / H 100 mm
Ø 90 mm

745092000 7.30
 





**Becher
Gobelet**
indigo/indigo
31 cl / H 100 mm
Ø 90 mm

745093000 7.30
 





**Becher
Gobelet**
grau/gris
31 cl / H 100 mm
Ø 90 mm

745094000 7.30
 





**Becher
Gobelet**
marineblau/bleu marine
31 cl / H 100 mm
Ø 90 mm

745095000 7.30
 





**Becher
Gobelet**
tannengrün/vert sapin
31 cl / H 100 mm
Ø 90 mm

745096000 7.30
 





**Becher
Gobelet**
hellgrün/vert clair
31 cl / H 100 mm
Ø 90 mm

745098000 7.30
 



**Becher
Gobelet**
amber/ambre
31 cl / H 100 mm
Ø 90 mm



745097000 7.30
 



moscow mule & julep mug



Moscow Mule
50 cl / H 100 mm
Ø 90 mm

8582.93311 19.95
 



Moscow Mule
50 cl / H 100 mm
Ø 90 mm

8582.93323 19.95
 





Moscow Mule
50 cl / H 100 mm
Ø 90 mm

8582.93346 19.95
 





Moscow Mule
45 cl / H 90 mm
Ø 90 mm

8582.93310 19.95
 



Moscow Mule
45 cl / H 90 mm
Ø 90 mm

8582.93322 19.95
 



Moscow Mule
45 cl / H 90 mm
Ø 90 mm

8582.93345 19.95
 



Julep Mug
35 cl / H 100 mm
Ø 85 mm

8582.93328 19.95
 



Julep Mug
35 cl / H 100 mm
Ø 85 mm

8582.93327 19.95
 



Julep Mug
35 cl / H 100 mm
Ø 85 mm

8582.93329 19.95
 



Julep Mug
40 cl / H 115 mm
Ø 80 mm

8582.93337 19.95
 



Julep Mug
40 cl / H 115 mm
Ø 80 mm

8582.93336 19.95
 















Julep Mug
40 cl / H 115 mm
Ø 80 mm













8582.93338 19.95
 















cocktail

					
Cylinder Bud 20 cl / H 190 mm Max Ø 44 mm Top Ø 44 mm	Cylinder Bud 20 cl / H 190 mm Max Ø 44 mm Top Ø 44 mm	Becher auf Fuss Gobelet sur pied 36 cl Ø 75 mm x H 122 mm	Becher auf Fuss Gobelet sur pied 27 cl Ø 75 mm x H 101 mm	Becher auf Fuss Gobelet sur pied 34 cl Ø 57 mm x H 179 mm	Becher auf Fuss Gobelet sur pied 20 cl Ø 51 mm x H 133 mm
711061000 3.05	711061010 3.95	711911000 7.30	711912000 6.60	711910000 7.30	711913000 6.60
					













					
Napoli grande 45,8 cl / H 216 mm Max Ø 79 mm Top Ø 79 mm	Hurricane 44 cl / H 207 mm Max Ø 80 mm Top Ø 80 mm	Mixology Gin Tonic 80 cl / H 205 mm Max Ø 119 mm Top Ø 102 mm	Mixology Spritz 57 cl / H 225 mm Max Ø 91 mm Top Ø 70 mm	Mixology Cocktail 22,5 cl / H 140 mm Max Ø 95 mm Top Ø 95 mm	Mixology Nick&Nora 15 cl / H 147 mm Max Ø 68 mm Top Ø 68 mm
711038000 7.95	8004.10020 8.95	7081.73015 11.45	7081.73016 11.15	7081.73019 9.15	7081.73018 8.35
					

					
America 20's 74,5 cl / H 226 mm Max Ø 109 mm Top Ø 92 mm	Cocktailparty 65 cl / H 190 mm Max Ø 110 mm Top Ø 93 mm	Premium 75,5 cl / H 218 mm Max Ø 108 mm Top Ø 91 mm	Timeless 50 cl / H 198 mm Max Ø 108 mm	Timeless 23 cl / H 172 mm Max Ø 116 mm	Classico 27 cl / H 179 mm Max Ø 117 mm
7070.58000 11.95	7080.58400 5.55	7080.58410 7.95	7080.58420 6.35	7080.58430 5.85	8003.00086 7.30
					













					
Nick & Nora 15 cl / H 143 mm Max Ø 70 mm Top Ø 70 mm	Bartender sour 45,5 cl / H 117 mm Max Ø 85 mm Top Ø 85 mm	Bartender sweet 44 cl / H 117 mm Max Ø 85 mm Top Ø 85 mm	America 20's 27,5 cl / H 206 mm Max Ø 66 mm Top Ø 66 mm	America 20's 40 cl / H 224 mm Max Ø 75 mm Top Ø 75 mm	America 20's 51 cl / H 239 mm Max Ø 81 mm Top Ø 81 mm
5600.66012 6.90	8004.18200 4.75	8004.18100 4.75	7070.58001 6.10	7070.58002 7.05	7070.58003 8.35
					





















digestif



















			
Vinotheque Grappa 10,5 cl / H 202 mm Max Ø 64 mm Top Ø 44 mm	Vinotheque Grappa 10,5 cl / H 202 mm Max Ø 64 mm Top Ø 44 mm	Vinotheque Cognac 17 cl / H 165 mm Max Ø 69 mm Top Ø 44 mm	Vinotheque Cognac 17 cl / H 165 mm Max Ø 69 mm Top Ø 44 mm
7081.64193 6.90	7081.64195 8.65	7081.64192 7.15	7081.64194 9.05
 	 	 	 



			
Spirits Sherry 12 cl / H 190 mm Max Ø 60 mm Top Ø 60 mm	Spirits Sherry 12 cl / H 190 mm Max Ø 60 mm Top Ø 60 mm	Spirits Rhum 17 cl / H 127 mm Max Ø 75 mm Top Ø 75 mm	Spirits Rhum 17 cl / H 127 mm Max Ø 75 mm Top Ø 75 mm
5600.66001 5.70	5600.66005 7.05	5600.66002 5.30	5600.66006 7.30
 	 	 	 



					
Arôme Spirits 18 cl / H 201 mm Max Ø 67 mm	Arôme Spirits 18 cl / H 148 mm Max Ø 67 mm	Arôme Spirits 63 cl / H 114 mm Max Ø 115 mm	Arôme Spirits 51 cl / H 128 mm Max Ø 106 mm	Arôme Spirits 36 cl / H 118 mm Max Ø 96 mm	Arôme Spirits 25 cl / H 108 mm Max Ø 85 mm
711930000 4.75	711931000 3.85	711932000 5.15	711933000 4.75	711934000 4.35	711935000 3.85
 	 	 	 	 	 

					
Glencairn 19 cl / H 117 mm Max Ø 66 mm Top Ø 46 mm	Glencairn 19 cl / H 117 mm Max Ø 66 mm Top Ø 46 mm	Fluted Lined 5,9 cl / H 75 mm Max Ø 55 mm Top Ø 48 mm	Fluted Lined 5,9 cl / H 75 mm Max Ø 55 mm Top Ø 48 mm	Fluted Whiskey 2,6 cl / H 57 mm Max Ø 49 mm Top Ø 49 mm	Pressed Whiskey 4,4 cl / H 70 mm Max Ø 55 mm Top Ø 55 mm
7080.58300 8.75	7080.58301 9.85	711009000 1.95	711009108 2.60	711041000 1.95	711031000 2.50
 	 	 	 	 	 





warm beverage

warm beverage





Espressotasse auf Fuss
Tasse à espresso sur pied
8 cl / H 74,5 mm
Ø 75 mm

711920000 2.65
 





Kaffeetasse auf Fuss
Tasse à café sur pied
22 cl / H 89,3 mm
Ø 108 mm

711921000 2.95
 





Becher Gobelet
9 cl / H 63 mm
Max Ø 6,4 cm

8004.04100 6.10
 





Becher Gobelet
23,4 cl / H 90 mm
Max Ø 8,3 cm

8004.04101 7.05
 





Becher Gobelet
39,2 cl / H 107 mm
Max Ø 12,5cm

8004.04102 9.05
 





Becher Gobelet
42,2 cl / H 150 mm

8004.04103 9.70
 



Caffeino
9 cl / H 70 mm
Max Ø 58 mm
Top Ø 58 mm

715616000 1.85
 





Shetland
15 cl / H 90 mm
Max Ø 70 mm
Top Ø 70 mm

8004.12099 2.25
 





Zinc
10 cl / H 68 mm
Max Ø 70 mm
Top Ø 70 mm

8004.25100 5.60
 





Zinc
20 cl / H 93 mm
Max Ø 85 mm
Top Ø 85 mm

8004.25110 7.25
 



Teebecher
Verre à thé
23 cl / H 107 mm
Max Ø 107 mm
Top Ø 70 mm

1500.06013 3.55
 



Bock sur pied
29 cl / H 14,2 cm
Max/Top Ø 7 cm
Fuss/Pied: Ø 6,9 cm

1500.06029 5.85
 





Acapulco
28 cl / H 149 mm
Max Ø 92 mm
Top Ø 76 mm

8004.12810 3.85
 





Latte Macchiato
33 cl / H 152 mm
Max Ø 69 mm
Top Ø 69 mm

8004.12802 5.05
 





Latte Macchiato
33 cl / H 152 mm
Max Ø 69 mm
Top Ø 69 mm

8004.12801 5.05
 





Kenia Espresso-Tasse
Tasse à espresso
8 cl / H 57 mm
Max Ø 59 mm
Top Ø 59 mm

8442.14876 3.45
 



Kenia Mug
31 cl / H 103 mm
Max Ø 82 mm
Top Ø 82 mm

8442.14874 3.95
 



Kenia Macchiato
32 cl / H 143 mm
Max Ø 72 mm
Top Ø 72 mm

8442.14221 5.55
 



Arcadie Becher Gobelet
9 cl / H 63 mm
Max Ø 59 mm
Top Ø 59 mm

1500.51005 1.70
 





Arcadie Espresso-Untere
Soucoupe espresso
Ø 110 mm

1500.51006 2.65
 





Arcadie Becher Gobelet
35 cl / H 98 mm
Max Ø 96 mm
Top Ø 96 mm

1500.51002 2.85
 



Arcadie Becher Gobelet
40 cl / H 126 mm
Max Ø 93 mm
Top Ø 93 mm

1500.51001 3.45
 



Arcadie Kombi-Untere
Soucoupe multiple
Ø 140 mm

1500.51007 2.85
 



thermic

! **Eingeschränkte Robustheit**
robustesse limitée



Caffeino Thermic
8,5 cl / H 74 mm
Max/Top Ø 62 mm

7081.20022 8.65



Espresso Thermic
12 cl / H 80 mm
Max/Top Ø 70 mm

8004.12122 13.30



Espressino Thermic
10,5 cl / H 82 mm
Max/Top Ø 67 mm

7081.20021 10.90



Coffee/Tea Thermic
29,5 cl / H 113 mm
Max/Top Ø 86 mm

8004.12123 17.30



Giant Mug Thermic
38,5 cl / H 80 mm
Max/Top Ø 120 mm

8004.12124 23.45



Caffé aroma Thermic
30 cl / H 115 mm
Max/Top Ø 87 mm

7081.20025 17.30



Tazza Thermic
32 cl / H 113 mm
Max/Top Ø 85 mm

7081.20024 18.10



Irish Coffee Thermic
25 cl / H 157 mm
Max Ø 78 mm

7081.20050 29.30



Succo Thermic
27 cl / H 113 mm
Max/Top Ø 82 mm

7081.20023 13.30



Latte Macchiato Thermic
34 cl / H 150 mm
Max/Top Ø 91 mm

7081.20020 18.10



Cremier Thermic
14,5 cl / H 92 mm
Max Ø 68 mm

7081.20035 16.25



Michelangelo Thermic
11 cl / H 67 mm
Max Ø 67 mm

7081.20000 8.65



Conico Thermic
12 cl / H 65 mm
Max Ø 74 mm

7081.20001 8.65



Cilindrico Thermic
11 cl / H 69 mm
Max Ø 63 mm

7081.20002 8.65



Ametista Thermic
11,5 cl / H 63 mm
Max Ø 76 mm

7081.20003 8.65



Chopin Thermic
11 cl / H 69 mm
Max Ø 75 mm

7081.20004 8.65

24 cl / H 85 mm
Max Ø 83 mm

7081.20012 12.25

24 cl / H 86 mm
Max Ø 81 mm

7081.20014 12.25

22 cl / H 86 mm
Max Ø 93 mm

7081.20010 12.25

23 cl / H 83 mm
Max Ø 93 mm

7081.20011 12.25



teatime



YUNA
Teekanne
Théière
120 cl / H 130 mm
Ø 150 mm

161414100

58.55



FUSION
Teekanne
Théière
100 cl / H 150 mm
Ø 180 mm

161143100

81.15



TUTO
Stövchen
Rechaud
H 55 mm
Ø 145 mm

161402100

29.35



ORIENT+
Teekanne
Théière
150 cl / H 150 mm
Ø 180 mm

161143100

81.15



TUTO
Stövchen
Rechaud
H 55 mm
Ø 160 mm

161164100

32.90

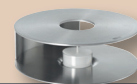

LIMBO
Stövchen
Rechaud
H 50 mm
Ø 160 mm

161294100











29.35



Gusseisen-Teekannen finden Sie im Kapitel Service, Seite 301-303
Théières en fonte vous trouvez au chapitre service, page 301-303



mini patisserie



















				
Mini-Tortenplatte mit Cloche Plat de gâteau mini avec cloche Ø 100 mm, H 180 mm	Mini-Tortenplatte mit Cloche Plat de gâteau mini avec cloche Ø 100 mm, H 190 mm	Schälchen auf Fuss mit Cloche Coupelle sur pied avec cloche Ø 115 mm, H 190 mm	Schälchen mit Cloche Coupelle avec cloche Ø 110 mm	Schälchen mit Cloche Coupelle avec cloche Ø 80 mm
7080.41200 8.90	7080.41210 8.20	7080.41220 9.85	7080.41240 5.60	7080.41250 4.45
 12	 12	 6	 12	 24













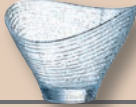











coupes

coupes



					
Country 38 cl / H 118 mm Max/Top Ø 115 mm	Funchal 16 cl / H 80 mm Max/Top Ø 98 mm	Sorbet 21 cl / H 78 mm Max/Top Ø 100 mm	Sorbet 38 cl / H 94 mm Max/Top Ø 117 mm	Palmier 21 cl / H 101 mm Max/Top Ø 125 mm	Palmier 37 cl / H 197 mm Max/Top Ø 102 mm
711918000 4.65  	711919000 4.65  	7080.58062 5.85  	7080.58063 7.05  	8004.10092 7.55  	8004.10093 13.05  

					
Quadro 31,1 cl / H 191 mm Max/Top Ø 81 mm	Jazzed 35 cl / H 197 mm Max/Top Ø 120 mm	Jazzed 25 cl / H 92 mm Max/Top Ø 125 mm	Jazzed Frozen 25 cl / H 92 mm Max/Top Ø 125 mm	Pépite 20 cl / H 60 mm Max/Top Ø 108 mm	Perigord 22 cl / H 97 mm Max/Top Ø 110 mm
8004.10026 9.15  	8004.10064 12.75  	8004.10071 8.50  	8004.10073 8.50  	8004.10080 3.45  	8004.25086 6.95  

					
Fortuna 32 cl / H 180 mm Max/Top Ø 125 mm	Primavera 24 cl / H 137 mm Max/Top Ø 135 mm	Diamond 22 cl / H 85 mm Max/Top Ø 100 mm	Diamond 36 cl / H 99 mm Max/Top Ø 117 mm	Gigogne 25 cl / H 101 mm Max/Top Ø 99 mm	Ondine 24 cl / H 52 mm Max/Top Ø 110 mm
8004.10100 7.55  	8004.10102 5.70  	8004.10210 3.95  	8004.10211 4.65  	7088.43000 3.95  	7088.42040 2.25  



decanters & carafes

First Class Dekanter Décanteur H 117 mm Ø 88 mm - 1 dl 8004.17581 21.50	First Class Dekanter Décanteur H 132 mm Ø 105 mm - 2 dl 8004.17582 23.50	First Class Dekanter Décanteur H 152 mm Ø 117 mm - 3 dl 8004.17583 28.20	First Class Dekanter Décanteur H 176 mm Ø 137 mm - 5 dl 8004.17585 34.05	Vino Grande Dekanter Décanteur 100 cl / H 200 mm Ø 194 mm 7082.64359 52.90	Vino Grande Dekanter Décanteur 150 cl / H 233 mm Ø 224 mm 7082.64357 65.85

Karaffe mit Deckel Carafe avec couvercle 110 cl / H 310 mm Max Ø 100 mm Top Ø 88 mm 7090.00065 33.50	Krug Jug 1,8 l / H 230 mm Max Ø 160 mm Top Ø 160 mm 711010000 15.25	Krug* Cruche* 10 cl / H 93 mm Max Ø 80 mm Top Ø 39 mm - 1 dl 8004.17110 23.50	Krug* Cruche* 20 cl / H 111 mm Max Ø 96 mm Top Ø 43 mm - 2 dl 8004.17210 25.85	Krug* Cruche* 30 cl / H 120 mm Max Ø 111 mm Top Ø 54 mm - 3 dl 8004.17310 26.95	Krug* Cruche* 50 cl / H 145 mm Max Ø 128 mm Top Ø 62 mm - 5 dl 8004.17510 28.20

* Mundgeblasen/Soufflé à la bouche

decanters & carafes



Budelle Karaffe Carafe 10 cl / H 144 mm Max Ø 54 mm Top Ø 50 mm - 1 dl 715689010 10.55	Budelle Karaffe Carafe 20 cl / H 178 mm Max Ø 65 mm Top Ø 53 mm - 2 dl 715689020 11.70	Budelle Karaffe Carafe 20 cl / H 178 mm Max Ø 65 mm Top Ø 53 mm - 1+2 dl 715689012 11.70	Budelle Karaffe Carafe 30 cl / H 206 mm Max Ø 70 mm Top Ø 56 mm - 3 dl 715689030 14.30	Budelle Karaffe Carafe 50 cl / H 232 mm Max Ø 85 mm Top Ø 67 mm - 3+5 dl 715689035 15.95	Budelle Karaffe Carafe 50 cl / H 232 mm Max Ø 85 mm Top Ø 67 mm - 5 dl 715689050 15.95
--	--	--	--	--	--

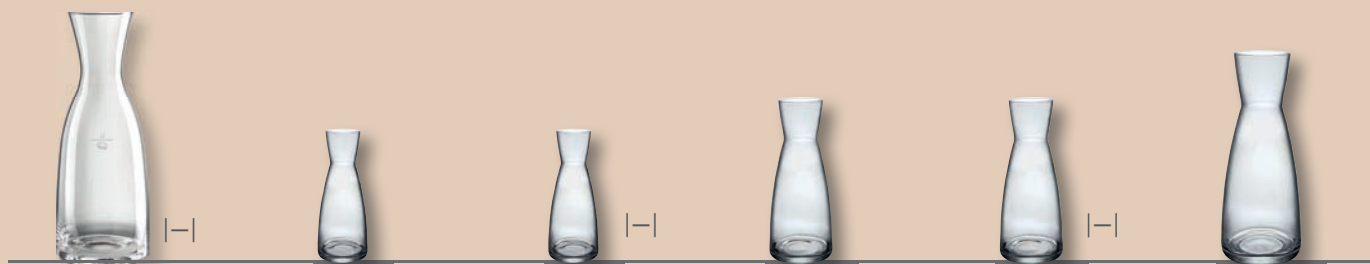

Budelle Karaffe Carafe 100 cl / H 282 mm Max Ø 108 mm Top Ø 73 mm - 1 L 715689100 19.15	Ypsilon Karaffe Budelle 28,5 cl / H 165 mm Max Ø 67 mm Top Ø 44 mm 8004.17002 5.85	Ypsilon Karaffe Budelle 28,5 cl / H 165 mm Max Ø 67 mm Top Ø 44 mm - 1+2 dl 8004.17003 9.35	Ypsilon Karaffe Budelle 55 cl / H 205 mm Max Ø 83 mm Top Ø 55 mm 8004.17001 7.95	Ypsilon Karaffe Budelle 55 cl / H 205 mm Max Ø 83 mm Top Ø 55 mm - 3+5 dl 8004.17004 11.70	Ypsilon Karaffe Budelle 100 cl / H 255 mm Max Ø 104 mm Top Ø 69 mm 8004.17000 11.70
---	---	---	---	--	--



Atelier Karaffe Carafe 15 cl / H 133 mm Max Ø 56 mm Top Ø 37 mm - 1 dl 7081.66001 6.30	Atelier Karaffe Carafe 32 cl / H 174 mm Max Ø 73 mm Top Ø 47 mm - 2+3 dl 7081.66004 7.25	Atelier Karaffe Carafe 64 cl / H 260 mm Max Ø 90 mm Top Ø 58 mm - 5 dl 7081.66005 8.90	Atelier Karaffe Carafe 120 cl / H 280 mm Max Ø 108 mm Top Ø 63 mm - 1 l 7081.66010 14.30	Flasche mit Kork-Stopper Bouteille avec bouchon en liège 1 L / H 263 mm Max Ø 89 mm 7081.70010 17.60	Flasche Bouteille 100 cl / H 28,1 cm Max Ø 8,9 cm 7070.58215 6.95
--	--	--	--	---	---

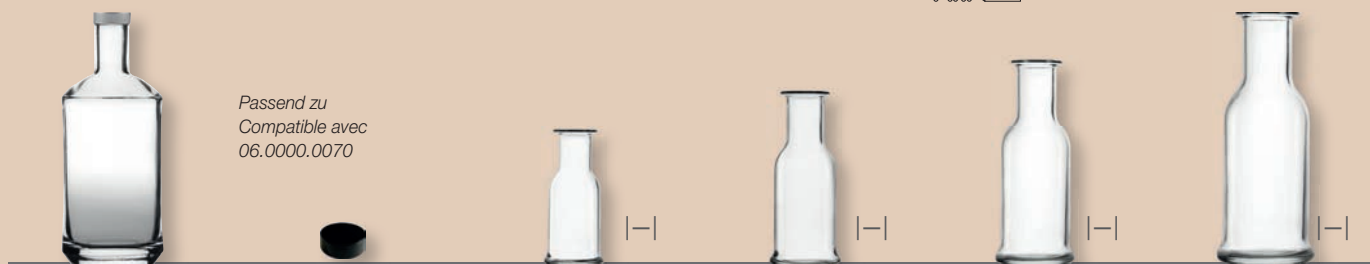

Flasche Bouteille 70 cl, H 227 mm Max Ø 90 mm 06.0000.0070 6.50	Deckel schwarz Couvercle noir Ø 33 mm 7070.58469 0.80	Purity Karaffe Carafe 10 cl / H 130 mm Max Ø 57 mm - 1 dl 8004.17020 6.10	Purity Karaffe Carafe 25 cl / H 175 mm Max Ø 75 mm - 2+3 dl 8004.17021 7.25	Purity Karaffe Carafe 50 cl / H 220 mm Max Ø 85 mm - 5 dl 8004.17022 9.85	Purity Karaffe Carafe 100 cl / H 265 mm Max Ø 100 mm - 1 l 8004.17023 14.30
---	--	--	--	--	--

Passend zu
Compatible avec
06.0000.0070





new galaxy



Teller flach
Assiette plate
Ø 210 mm

1509.34321

3.70



Teller flach
Assiette plate
Ø 240 mm

1509.34324

4.20



Teller flach
Assiette plate
Ø 280 mm

1509.34328

5.70



Teller flach
Assiette plate
Ø 320 mm

1509.34332

7.70

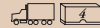

Coupteller
Assiette coupe
Ø 160 mm

1509.34116

4.75

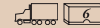

Coupteller
Assiette coupe
Ø 180 mm

1509.34118

5.55

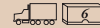

Schale
Coupelle
Ø 110 mm

1509.34011

3.70



Schale
Coupelle
Ø 140 mm

1509.34014

4.20



Schale
Coupelle
Ø 170 mm

1509.34017

5.55



Schale
Saladier
Ø 210 mm

1509.34021

9.15



Schale
Saladier
Ø 250 mm

1509.34025

12.75



Schale
Saladier
Ø 290 mm

1509.34029

15.05





orfilia

Coupeteller Assiette plate coupe Ø 22 cm	Coupeteller Assiette plate coupe Ø 28 cm	Coupeteller Assiette plate coupe Ø 33 cm	Platte mit Rand Assiette plate à bord Ø 21,5 x H 2 cm	Platte mit Rand Assiette plate à bord Ø 28 x H 2 cm	Coupeteller tief Assiette creuse coupe Ø 20,5 x H 3,6 cm
1509.34340 4.75	1509.34341 7.05	1509.34342 9.30	1509.34343 7.05	1509.34344 9.30	1509.34345 5.55

Schüssel Saladier Ø 13,7 x H 5 cm	Schüssel Saladier Ø 16,5 x H 6 cm	Schüssel Saladier Ø 21 x H 7,8 cm	Schüssel Saladier Ø 25 x H 9 cm
1509.34346 3.70	1509.34347 5.55	1509.34348 8.35	1509.34349 12.75



circle



Teller flach
Assiette plate
Ø 150 mm

715739000

3.95



Teller flach
Assiette plate
Ø 210 mm

715740100

5.05



Teller flach
Assiette plate
Ø 240 mm

715741000

6.65



Teller flach
Assiette plate
Ø 270 mm

715742000

8.25



Teller flach
Assiette plate
Ø 300 mm

715743000

11.15

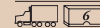

Teller tief
Assiette creuse
Ø 135/255 mm

715746000

9.85



Teller tief
Assiette creuse
Ø 200 mm

715746100

5.85



Kanu-Schale
Kanu coupelle
Ø 320 mm

715749100

9.30



Schale
Coupelle
Ø 130 mm
H 55 mm

715745000

4.65



Schale
Saladier
Ø 170 mm
H 100 mm

715745100

5.05



Schüssel
Saladier
Ø 345 mm
H 130 mm

715738000

22.10



























ARCOROC



empilable

 **Bärenstark**
très robuste

					
Schale Coupelle 3,5 cl / H 27 mm Ø 60 mm	Schale Coupelle 7,5 cl / H 35 mm Ø 70 mm	Schale Coupelle 15 cl / H 41 mm Ø 90 mm	Schale Coupelle 24 cl / H 49 mm Ø 100 mm	Schale Saladier 38,5 cl / H 55 mm Ø 120 mm	Schale Saladier 50 cl / H 65 mm Ø 140 mm
7157.01000 0.95 	7157.02000 1.00 	7157.03000 1.30 	7157.04000 1.20 	7157.05000 1.50 	7157.06000 2.65 
					
Schale Saladier 110 cl / H 78 mm Ø 170 mm	Schale Saladier 180 cl / H 92 mm Ø 200 mm	Schale Saladier 290 cl / H 105 mm Ø 230 mm	Schale Saladier 430 cl / H 119 mm Ø 260 mm	Schale Saladier 600 cl / H 133 mm Ø 290 mm	Schale eckig Coupelle carrée 30 cl / H 46 mm 110 x 110 mm
7157.07000 2.95 	7157.08000 4.65 	7157.09000 5.85 	7157.10000 8.90 	7157.11000 11.70 	7088.42008 1.85 



unbreakable



unbreakable



Wein Vin
20 cl / H 151 mm
Max Ø 70 mm
Top Ø 65 mm

Wein Vin
30 cl / H 170 mm
Max Ø 76 mm
Top Ø 72 mm

Sekt Flûte
17 cl / H 176 mm
Max Ø 54 mm
Top Ø 51 mm

8330.90010 7.05
 

8330.90011 7.15
 

8330.90012 7.05
 





Tumbler Tumbler
25 cl / H 79 mm
Max Ø 74 mm
Top Ø 74 mm



Tumbler Tumbler
35 cl / H 85 mm
Max Ø 85 mm
Top Ø 85 mm



Longdrink Longdrink
22 cl / H 148 mm
Max Ø 52 mm
Top Ø 52 mm

Longdrink Longdrink
32,5 cl / H 151 mm
Max Ø 61 mm
Top Ø 61 mm

8330.90016 5.95
 

8330.90017 7.95
 

8330.90014 5.70
 

8330.90015 7.05
 



Polycarbonat
Polycarbonate



Becher Gobelet
25 cl / H 90 mm
Max Ø 83 mm
Top Ø 83 mm

Becher Gobelet
30 cl / H 122 mm
Max Ø 77 mm
Top Ø 77 mm

Becher Gobelet
40 cl / H 135 mm
Max Ø 84 mm
Top Ø 84 mm

Trinkbecher Gobelet
15 cl / H 95 mm
Max Ø 70 mm
Top Ø 70 mm

Trinkbecher Gobelet
30 cl / H 125 mm
Max Ø 80 mm
Top Ø 80 mm

Trinkbecher Gobelet
50 cl / H 155 mm
Max Ø 90 mm
Top Ø 90 mm



8330.90018 5.70
 

8330.90019 6.90
 

8330.90020 9.30
 

8582.10500 4.90
 

8582.10501 6.65
 

8582.10502 7.95
 



Trinkbecher Gobelet
15 cl / H 80 mm
Max Ø 65 mm
Top Ø 65 mm



Trinkbecher Gobelet
22 cl / H 80 mm
Max Ø 85 mm
Top Ø 85 mm



Trinkbecher Gobelet
30 cl / H 100 mm
Max Ø 85 mm
Top Ø 85 mm



Trinkbecher Gobelet
40 cl / H 120 mm
Max Ø 85 mm
Top Ø 85 mm



Trinkbecher Gobelet
50 cl / H 150 mm
Max Ø 85 mm
Top Ø 85 mm

8582.10560 3.95
 

8582.10561 4.35
 

8582.10562 5.05
 

8582.10563 5.70
 

8582.10564 6.50
 

unbreakable



Cloche
Cloche
Ø 210 mm
H 170 mm

8582.06519

35.15



Cloche
Cloche
Ø 300 mm
H 200 mm

8582.06520

45.85



Cloche
Cloche
Ø 360 mm
H 270 mm

8582.06521

84.55



Cloche
Cloche
Ø 300 mm
H 400 mm

8582.06525

69.35



Trinkbecher
Gobelet
blue sky
15 cl / H 95 mm
Max Ø 70 mm
Top Ø 70 mm

8582.10513

4.90



Trinkbecher
Gobelet
blue sky
30 cl / H 125 mm
Max Ø 80 mm
Top Ø 80 mm

8582.10514

6.65



Trinkbecher
Gobelet
blue sky
50 cl / H 155 mm
Max Ø 90 mm
Top Ø 90 mm

8582.10515

7.95



Trinkbecher
Gobelet
red star
15 cl / H 95 mm
Max Ø 70 mm
Top Ø 70 mm

8582.10510

4.90



Trinkbecher
Gobelet
red star
30 cl / H 125 mm
Max Ø 80 mm
Top Ø 80 mm

8582.10511

6.65



Trinkbecher
Gobelet
red star
50 cl / H 155 mm
Max Ø 90 mm
Top Ø 90 mm

8582.10512

7.95



Trinkbecher
Gobelet
french grey
15 cl / H 95 mm
Max Ø 70 mm
Top Ø 70 mm

8582.10525

4.90



Trinkbecher
Gobelet
french grey
30 cl / H 125 mm
Max Ø 80 mm
Top Ø 80 mm

8582.10526

6.65



Trinkbecher
Gobelet
french grey
50 cl / H 155 mm
Max Ø 90 mm
Top Ø 90 mm

8582.10527

7.95



Trinkbecher
Gobelet
purple
15 cl / H 95 mm
Max Ø 70 mm
Top Ø 70 mm

8582.10528

4.90



Trinkbecher
Gobelet
purple
30 cl / H 125 mm
Max Ø 80 mm
Top Ø 80 mm

8582.10529

6.65



Trinkbecher
Gobelet
purple
50 cl / H 155 mm
Max Ø 90 mm
Top Ø 90 mm

8582.10530

7.95



Trinkbecher
Gobelet
apricot
15 cl / H 95 mm
Max Ø 70 mm
Top Ø 70 mm

8582.10531

4.90



Trinkbecher
Gobelet
apricot
30 cl / H 125 mm
Max Ø 80 mm
Top Ø 80 mm

8582.10532

6.65



Trinkbecher
Gobelet
apricot
50 cl / H 155 mm
Max Ø 90 mm
Top Ø 90 mm

8582.10533

7.95



Trinkbecher
Gobelet
green
15 cl / H 95 mm
Max Ø 70 mm
Top Ø 70 mm

8582.10534

4.90



Trinkbecher
Gobelet
green
30 cl / H 125 mm
Max Ø 80 mm
Top Ø 80 mm

8582.10535

6.65



Trinkbecher
Gobelet
green
50 cl / H 155 mm
Max Ø 90 mm
Top Ø 90 mm

8582.10536

7.95



unbreakable



**Trinkbecher
Gobelet**
french grey
15 cl / H 80 mm
Max Ø 65 mm
Top Ø 65 mm

**Trinkbecher
Gobelet**
french grey
22 cl / H 80 mm
Max Ø 85 mm
Top Ø 85 mm

**Trinkbecher
Gobelet**
french grey
30 cl / H 100 mm
Max Ø 85 mm
Top Ø 85 mm

**Trinkbecher
Gobelet**
french grey
40 cl / H 120 mm
Max Ø 85 mm
Top Ø 85 mm

**Trinkbecher
Gobelet**
french grey
50 cl / H 150 mm
Max Ø 85 mm
Top Ø 85 mm

8582.10565

3.95

8582.10566

4.35

8582.10567

5.05

8582.10568

5.70

8582.10569

6.50



**Trinkbecher
Gobelet**
light green
15 cl / H 80 mm
Max Ø 65 mm
Top Ø 65 mm

**Trinkbecher
Gobelet**
light green
22 cl / H 80 mm
Max Ø 85 mm
Top Ø 85 mm

**Trinkbecher
Gobelet**
light green
30 cl / H 100 mm
Max Ø 85 mm
Top Ø 85 mm

**Trinkbecher
Gobelet**
light green
40 cl / H 120 mm
Max Ø 85 mm
Top Ø 85 mm

**Trinkbecher
Gobelet**
light green
50 cl / H 150 mm
Max Ø 85 mm
Top Ø 85 mm

8582.10570

3.95

8582.10571

4.35

8582.10572

5.05

8582.10573

5.70

8582.10574

6.50



**Trinkbecher
Gobelet**
light pink
15 cl / H 80 mm
Max Ø 65 mm
Top Ø 65 mm

**Trinkbecher
Gobelet**
light pink
22 cl / H 80 mm
Max Ø 85 mm
Top Ø 85 mm

**Trinkbecher
Gobelet**
light pink
30 cl / H 100 mm
Max Ø 85 mm
Top Ø 85 mm

**Trinkbecher
Gobelet**
light pink
40 cl / H 120 mm
Max Ø 85 mm
Top Ø 85 mm

**Trinkbecher
Gobelet**
light pink
50 cl / H 150 mm
Max Ø 85 mm
Top Ø 85 mm

8582.10575

3.95

8582.10576

4.35

8582.10577

5.05

8582.10578

5.70

8582.10579

6.50



**Trinkbecher
Gobelet**
light blue
15 cl / H 80 mm
Max Ø 65 mm
Top Ø 65 mm

**Trinkbecher
Gobelet**
light blue
22 cl / H 80 mm
Max Ø 85 mm
Top Ø 85 mm

**Trinkbecher
Gobelet**
light blue
30 cl / H 100 mm
Max Ø 85 mm
Top Ø 85 mm

**Trinkbecher
Gobelet**
light blue
40 cl / H 120 mm
Max Ø 85 mm
Top Ø 85 mm

**Trinkbecher
Gobelet**
light blue
50 cl / H 150 mm
Max Ø 85 mm
Top Ø 85 mm

8582.10585

3.95

8582.10586

4.35

8582.10587

5.05

8582.10588

5.70

8582.10589

6.50







Service | Service





wine & bar



WMF



DIVA
Getränkekühler
Seau à boisson

spülmaschinenfest
lavable au lave-vaisselle

Cromargan®
55.0124.6040 7,3 L / 27,5 x 26,2 x H 17 cm   198.50



Passendes Kühlelement | Élément réfrigérante
55.0125.9990 25,3 x 24 cm x H 13,3 cm   98.90

WMF



DIVA
Kühlelement
Élément réfrigérante

Mit Kühlgelfüllung zum Einfrieren bis -18°C.
Stapelbar, spülmaschineneignet
Rempli de gel réfrigérant pour congeler jusqu'à -18°C.
Empilable, passe au lave-vaisselle

55.0125.9990 25,3 x 24 cm x H 13,3 cm   98.90

WMF



DIVA
Getränkekühlerständer
Support pour seu à boisson
Ø innen 30 cm
Ø interne 30 cm



Cromargan®
55.0126.6040 H 59,5 cm   398.75

WMF



PURE
Wein-/Sektühler
Seau à vin

Passend in Weinkühlerständer mit Durchmesser mindestens 16 cm
S'adapte aux supports de refroidisseurs de vin d'un diamètre d'au moins 16 cm



Cromargan®
06.0469.6040 4,7 L / Ø 19 cm x H 22 cm   139.80

WMF



PURE
Weinkühlerständer
Support pour seu à champagne

Ø innen 16 cm
Ø interne 16 cm



Cromargan®
06.0468.6040 Ø 25 cm x H 68,8 cm   293.85

wine & bar

WMF

CLASSIC
 Weiss-/Sektküher
 Seau à vin



Für 2 Flaschen. Passend in Weinkühlerständer mit Durchmesser mindestens 20 cm
 Pour 2 bouteilles. S'adapte aux supports de refroidisseurs de vin d'un diamètre d'au moins 20 cm

Cromargan®
 06.8051.6040 8 L / H 23,5 cm   211.50

WMF

Weinkühlerständer
 Support pour seau à champagne



Ø innen 20 cm
 Ø interne 20 cm

Cromargan®
 06.8452.6040 Ø 20 cm x H 60 cm   258.60

WMF



Weinkühler
 Seau à vin

doppelwandig, passend in Weinkühlerständer mit Durchmesser mindestens 12,5 cm
 double paroi, s'adapte aux supports de refroidisseurs de vin d'un diamètre d'au moins 12,5 cm

Cromargan®
 06.8239.6040 1,6 L / Ø 12 cm x H 19,5 cm   35.10

WMF

URBAN
 Weinkühler
 Seau à vin

Cromargan®
 55.0064.6040 3,2 L / Ø 16 cm x H 24 cm   105.75

Tischhalterung für Wein- und Sektküher
 Porte-seau a vin et champagne de table

Stahldraht verchromt
 Fil d'acier chromé

8005.03604 Ø 20 cm   92.80



ATMOSFERA «Giove»
Wein- und Sektkühler
Seau à vin et champagne

27 x 20,5 cm x H 21,5 cm

631002001	Materic Bronze			164.00
631003002	Vulcan Grey			164.00
631001003	Materic Gold			164.00



ATMOSFERA «Marte»
Wein-, und Sektkühler mit Einsatz
Seau à vin et champagne avec insert

Ø 29 cm x H 18,5 cm

631002004	Materic Bronze			234.50
631003005	Vulcan Grey			234.50
631001006	Materic Gold			234.50



Flaschenkühler
Seau réfrigérant à bouteilles

Geeignet für 0,5 – 1,5 l Flaschen
Pour bouteilles 0,5 – 1,5 l

Inox

8005.00422	Ø 12 cm	H 20 cm			30.20
------------	---------	---------	--	--	-------



COPPER
Flaschenkühler
Seau réfrigérant à bouteilles

Inox, aussen verkupfert und anlaufgeschützt, Hammerschlagoptik,
Doppelwandig für beste Isolierung, Geeignet für 0,5–1,5 l Flaschen
Inox, double-paroi pour la meilleure isolation,
pour bouteilles 0,5–1,5 l

8582.36074	Ø 12 cm	H 20 cm			38.70
------------	---------	---------	--	--	-------



CRYSTAL
Flaschenkühler
Seau réfrigérant à bouteilles

Doppelwandiger Kunststoff (SAN)
Matière plastique double-paroi (SAN)

8582.36062	Ø 13,5 cm	H 23 cm			13.25
------------	-----------	---------	--	--	-------

wine & bar



Flaschenkühler
Seau réfrigérant à bouteilles

Aus doppelwandigem Acryl mit Inoxring
Double-paroi acrylique, bague inox



Geeignet für 0,7 - 1,5 l Flaschen
Pour bouteilles 0,7 - 1,5 l

8582.36050 Ø 9,5 cm H 23 cm   33.50



ELEMENT
Flaschenkühler
Seau réfrigérant à bouteilles

Beton, mit möbelschonender Unterseite
Béton, avec base revêtue antirayures

8582.36090 Ø 12/10 x H 19 cm   28.55



ELEMENT BLACK
Flaschenkühler
Seau réfrigérant à bouteilles



Beton, mit möbelschonender Unterseite
Béton, avec base revêtue antirayures



8582.36099 Ø 12/10 x H 19 cm   30.20





Flaschenkühler
Seau réfrigérant à bouteilles

Inox, doppelwandig, für 0,7 bis 1,5 l Flaschen
Inox double-paroi, pour bouteilles de 0,7 à 1,5 l

schwarz | noir
8582.36127 Ø 12 x H 20 cm   31.25



blau | bleu
8582.36126 Ø 12 x H 20 cm   33.50

rot | rouge
8582.36125 Ø 12 x H 20 cm   33.50



Wein-, Sektkühler
Seau à vin et champagne

Aluminium, gold
Aluminium, couleur or

8009.69845 Ø 20 cm x H 20 cm   58.55



Wein-, Sektkühler
Seau à vin et champagne

Inox, doppelwandig, gewellt, mit Griffen
Inox, double paroi, ondulé, avec poignées

8009.69614 Ø 22,5 cm x H 23 cm   82.10



Wein-, Sektkühler
Seau à vin et champagne



Inox, doppelwandig, gewellt, mit Griffen
Inox, double paroi, ondulé, avec poignées



8009.69618 Ø 36 cm   188.20



«Stainless»
Wein-, Sektkühler
Seau à vin et champagne

Doppelwandig für beste Isolierung, aussen Hammerschlag-Optik
Double paroi pour une meilleur isolation, extérieur: surface martelée



inox
8582.36120 Ø 33 cm, H 20 cm, 8 L   105.40

kupfer-look | couleur cuivre
8582.36121 Ø 33 cm, H 20 cm, 8 L   105.40



Wein-, Sektkühler
Seau à vin et champagne



Inox poliert, doppelwandig für beste Isolation
Inox poli, double-paroi pour la meilleure isolation

8582.36044 Ø 44 cm x H 24 cm   164.65



Wein-, Sektkühler
Seau à vin et champagne

Inox, mit vergoldeten Griffen
Inox, avec poignées dorées

8005.03007 Ø 42 cm x H 28 cm   136.40

wine & bar



URBAN
Eisgefäß
Seau à glace

doppelwandig
double paroi

Cromargan®

55.0065.6040 Ø 14 cm x H 15 cm



124.50



Eisgefäß
Seau à glace

doppelwandig
double paroi

Cromargan®

55.0035.6040 0,7 L / Ø 12,5 cm x H 14,4 cm



93.85



Eiseimer
Seau à glace

Edelstahl, doppelwandig
Inox, double paroi

8009.69613 Ø 15 cm x H 16 cm



52.90



Eiseimer
Seau à glace

Edelstahl 18/10, seidenmatt poliert, inkl. Eiszange, doppelwandig
En inox 18/10, poli satiné mat, pince à glace inclus, double paroi

8005.03640 Ø 12,5 x H 18,0 cm / 1 L



93.75

8005.03641 Ø 15,5 x H 21,5 cm / 2 L



107.60

8005.03642 Ø 17,0 x H 19,5 cm / 3 L



115.85

8005.03643 Ø 20,0 x H 27,0 cm / 5 L



136.40

Eiszange Ersatz/Pince à glace

8005.03644 17 cm



7.95

sambonet

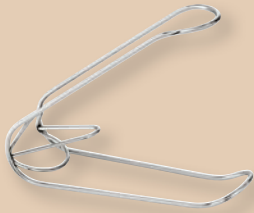
**ELITE**
Weingestell
Porte-bouteille

Inox
56123-00 14 cm   39.70

Versilbert auf Anfrage | Argenté sur demande

sambonet

**Weingestell**
Porte-bouteille



Geeignet für 7 dl Flaschen
Pour bouteilles 7 dl

Inox
41510-08   11.70

Versilbert auf Anfrage | Argenté sur demande



**Sektflaschen-Verschluss**
Fermeture champagne

verchromt, hochglänzend
chromé, poli brillant



8005.03826 Ø 3,5 x H 5,5 cm   7.50

**Wein-Vakuumpumpe**
Pompe à vin sous vide

Inox und Kunststoff, inkl. 2 Stopfen
Inox et matière plastique, 2 bouchons inclus

8582.93123 Ø 3,5 x H 15 cm   29.35

Stopfen 2er-Set | Bouchons, set à 2 pcs.

8582.93162   9.90

**DROP-STOP**
Weinausgiesser
Verseur à vin

8020.00001 Set à 10 pcs   31.50/Set

wine & bar



Dekantiertrichter
Entonnoir décanteur

mit Ständer
avec support

8102.16067 Ø 8,5 x H 15 cm



29.35



SCREWPULL
Korkenzieher
Tire-bouchon

Taschenmodell, Kunststoff
Modèle de poche, synthétique

8020.00041



46.90



PULLTEX «PULLTAPS»
Korkenzieher
Tire-bouchon

Spirale aus Teflon
Vrille Téflon

8020.00042 12 cm



19.95



SCREWPULL
Korkenzieher
Tire-bouchon

Inox/Kunststoff schwarz
Inox/Synthétique noir

8005.35315



37.60



«Profi»
Kellnermesser
Tire-bouchon de sommelier

Inox/Holz
Inox/bois

8582.93302 11,5 cm



16.40

**Kapselschneider
Coupe-capsule**

8020.00045



17.60

**Klingenkorkenzieher
Tire-bouchon bilame**
aus Metall mit Schutzhülle
en métal avec fourneau

8020.00040



26.95

**SCHOTT
Mehrweg-Trinkhalme aus Glas
Pailles réutilisables en verre**
50 Stk. Pack
50 pcs. pack

8003.50001 Ø 9 mm x 15 cm



93.75

8003.50002 Ø 9 mm x 20 cm



96.20

8003.50003 Ø 9 mm x 23 cm



98.55

Reinigungsbürste/Brosse de nettoyage

8003.50005 31,5 cm



4.90

**Mehrweg-Trinkhalme aus Glas
Pailles réutilisables en verre**
Set mit 50 Trinkhalmen + 3 Reinigungsbürsten
Set à 50 pailles et 3 brosses de nettoyage

7080.49001 Ø 8 mm x 20 cm



56.40/Set

7080.49002 Ø 8 mm x 20 cm



56.40/Set

7080.49003 Ø 8 mm x 20 cm



56.40/Set

7080.49004 Ø 8 mm x 20 cm



56.40/Set

**Mehrweg-Trinkhalme aus Edelstahl 10er Set, inkl. Reinigungsbürste
Pailles réutilisables en inox, set à 10, brosse de nettoyage incl.**

kupfer-look couleur cuivre

8582.93380 Ø 6 mm x 21,5 cm



21.15

8582.93383 Ø 8 mm x 21,5 cm



22.65

gunmetal couleur gunmetal

8582.93381 Ø 6 mm x 21,5 cm



21.15

8582.93384 Ø 8 mm x 21,5 cm



22.65

Ersatzbürste/brosse de recharge

8582.93386 24 cm



4.10



wine & bar

**Cocktail-Doppelmass****Double-mesure à cocktail**

Inox, hochglänzend, innen graduert (10, 20, 30, 40, 50 ml),
schwere Qualität

Inox, poli brillant, graduée à l'intérieur (10, 20, 30, 40, 50 ml), poids
élevé

8005.33111 3 / 5 cl



11.70

**Boston Shaker****Shaker Boston**

2-teilig, Becher inox 700 ml, Glas 400 ml

2 pièces, bol mélangeur inox 700 ml, bol en verre 400 ml

8582.93140 82 cl / Ø 8,9 x H 17,8 cm



21.15

Ersatzglas | Verre seul

8582.93138



13.25

**Barsieb****Tamis cocktail**

8582.93318 Ø 8,5 cm x 11,5 cm



6.95

**Barsieb****Tamis cocktail**

Edelstahl

Inox

8582.93312 Ø 9,5 cm x 18 cm

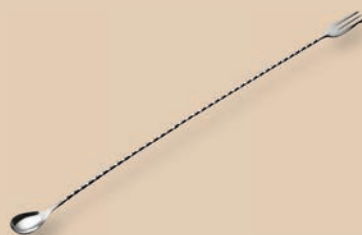

17.60

**Barlöffel****Cuillère**

Edelstahl

Inox

8582.93152 50 cm



11.70

Cocktaildoppelmass
Double-mesure à cocktail

20/40 ml

8014.00010	gold/couleur or			10.50
8014.00110	kupfer/couleur cuivre			10.50
8014.00210	anthrazit/antracite			10.50

Cocktailshaker
Cocktailshaker

500 ml, Ø 8,8 cm, H 20,5 cm

8014.00012	gold/couleur or			30.50
8014.00112	kupfer/couleur cuivre			30.50
8014.00212	anthrazit/antracite			30.50

Barsieb fine strainer
Tamis cocktail

Ø 10 cm

8014.00013	gold/couleur or			11.70
8014.00113	kupfer/couleur cuivre			11.70
8014.00213	anthrazit/antracite			11.70

Barsieb
Tamis cocktail

Ø 9 cm

8014.00014	gold/couleur or			16.35
8014.00114	kupfer/couleur cuivre			16.35
8014.00214	anthrazit/antracite			16.35

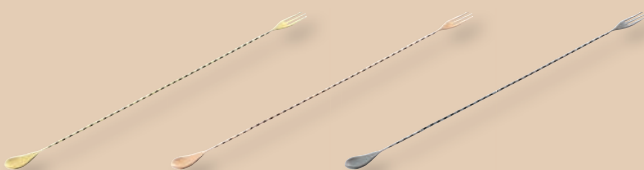
Barlöffel mit Gabel
Cuillère/fourchette à cocktail

50 cm

8014.00020	gold/couleur or			13.50
8014.00120	kupfer/couleur cuivre			13.50
8014.00220	anthrazit/antracite			13.50



holloware

**CLASSIC**
Kaffeekanne
Cafetière

Cromargan®

06.3501.6040	30 cl / H 13,5 cm			105.85
06.3502.6040	60 cl / H 17 cm			164.45

Versilbert auf Anfrage | Argenté sur demnade

**CLASSIC**
Teekanne
Théière

Cromargan®

06.3506.6040	30 cl / H 11 cm			117.40
06.3507.6040	60 cl / H 14,5 cm			164.45
06.3508.6040	130 cl / H 17,5 cm			269.00

Versilbert auf Anfrage | Argenté sur demnade

**CLASSIC**
Milchkanne
Pot à lait

Cromargan®

06.3512.6040	15 cl / H 8,5 cm			74.90
06.3513.6040	30 cl / H 11 cm			104.50
06.3514.6040	60 cl / H 13,5 cm			145.80

Versilbert auf Anfrage | Argenté sur demnade

**CLASSIC**
Zuckerdose, mit Deckel
Sucrier, avec couvercle

Cromargan®

06.3520.6040	15 cl / H 9,5 cm			82.10
06.3521.6040	25 cl / H 12 cm			99.55







Versilbert auf Anfrage | Argenté sur demnade

holloware

PURE
Kaffekanne
Cafetière

 teilmatiert, stapelbar
 partiell mâté, empilable

Cromargan®

06.3801.6040	30 cl / H 11,5 cm	 	38.80
06.3808.6040	60 cl / H 14 cm	 	43.90
06.3809.6040	1,9 L / H 20 cm	 	81.90

PURE
Teekanne
Théière

 teilmatiert, stapelbar
 partiell mâté, empilable

Cromargan®

06.3802.6040	30 cl / H 9,5 cm	 	34.00
--------------	------------------	---	-------

PURE
Milchkännchen
Pots à lait

 teilmatiert
 partiell mâté

Cromargan®

06.3806.6040	20 cl / H 8,5 cm	 	28.10
--------------	------------------	---	-------

PURE
Sahnegiesser
Crémier

 teilmatiert
 partiell mâté

Cromargan®

06.3807.6040	3 cl / H 5 cm	 	18.35
--------------	---------------	---	-------



PURE
Zuckerdose, mit Deckel
Sucrier, avec couvercle



teilmatiert
partiellement maté

Cromargan®
06.2342.6040 10 cl / Ø 6 cm x H 5,2 cm   21.05



PURE
Zuckerstangengefäss
Potsàsucrier



teilmatiert, stapelbar
partiellement maté, empilable

Cromargan®
06.7120.6040 Ø 6 cm x H 8,5 cm   27.50



PURE
Eisswasserkrug
Carafe à l'eau



mit Eislippe
avec lèvre en glace

Cromargan®
06.1865.6040 1,9 L / H 20 cm   79.80



COMPO
Eisswasserkrug
Carafe à l'eau



doppelwandig
double paroi

Cromargan®
55.0250.6040 1,5 L / H 22,3 cm   131.50

holloware



Isoliertes Kaffeeännchen
Petite cafetière isolée

Inox 18/10, zylindrische Form, hochglänzend, doppelwandig, stapelbar, mit Einhandklappdeckel, schwere Qualität
 Inox 18/10, forme cylindrique, très brillant, à double paroi, empilable, avec couvercle à charnière, qualité lourde

640325101 30 cl / H 10,5 cm   70.55

Kaffeeännchen, doppelwandig
Petite cafetière, double paroi



Inox 18/10, polierte Oberfläche, doppelwandig, mit Einhandklappdeckel, innenliegende Schwapprinne, ergonomischer Griff, schwere Qualität
 Inox 18/10, poli brillant, à double paroi, avec couvercle à charnière, qualité lourde

640324101 30 cl / H 10,5 cm   76.20

CNS-Kännchen, doppelwandig
CNS-pot, double paroi

Der Körper und der Deckel sind doppelwandig und somit durch Luft isoliert. Das Kännchen ist spülmaschinenfest, korrosionsbeständig und rostfrei.

Le corps et le couvercle sont en double paroi et isolé par air. Le pot est garanti au lave-vaisselle, anticorrosif et inoxydable.

8005.35162 30 cl / H 10,1 cm   84.55

helios

SERVE COFFEE
Edelstahlkännchen mit Klappdeckel
Pot isolante avec couvercle rabattable

Edelstahl matt, doppelwandig isoliert
 Acier inoxydable mat, isolation à double paroi

8275.11800 40 cl   50.55

ADVANCED
Isolierkanne
Pot isolant

doppelwandig, spülmaschinenfest, Einhandautomatik
 double paroi, garantie au lave-vaisselle, usage a 1 main

8582.10921 30 cl   65.85
 8582.10922 60 cl   76.20

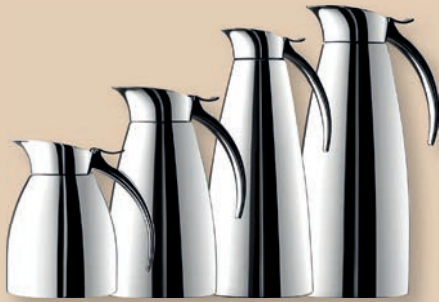
**ELEGANZA**
Isolierkanne
Pot isolant

Doppelwandiger, vakuumgepumpter Innoxkörper, unzerbrechlich und spülmaschinenfest
Corps en acier inox double paroi, isolation sous vide, incassable, garantie au lave-vaisselle

58.4517.9081	30 cl / H 16,4 cm			41.15
58.4517.9020	60 cl / H 19,3 cm			44.65
58.4517.9076	100 cl / 28,2 cm			50.55
58.4517.9082	130 cl / 31,4 cm			56.40

**BRILLIANT**
Isolierkanne
Cruche isolante

Edelstahl-Mantel hochglanzpoliert, doppelwandiger Edelstahlinsatz, Einhandautomatik
Acier inoxydable poli, empècement en inox, usage a 1 main

8275.00000	30 cl			78.55
8275.00001	60 cl			81.15
8275.00002	100 cl			86.90

**MEETING**
Isolierkanne
Cruche isolante

Doppelwandige Edelstahlkanne mit matter Oberfläche, Schraubverschluss, Spülmaschinenfest, Bruchsticher
Inox mat, double paroi, bouchon à tourner, lavable au lave-vaisselle, incassable

8275.11501	60 cl			69.35
8275.11502	100 cl			81.15
8275.11503	150 cl			91.60

Ersatzdeckel | Couvercle seul
STO2204

		17.15
--	--	-------

**HOTELLO**
Isolierkanne
Pot isolant

Doppelwandiger, vakuumgepumpter Innoxkörper, unzerbrechlich und spülmaschinenfest
Corps en acier inox double paroi, isolation sous vide, incassable, garantie au lave-vaisselle

8005.35589	30 cl			143.50
8005.35590	60 cl			148.20
8005.35591	100 cl			151.50
8005.35592	150 cl			173.95

holloware

Aellos

**CARAT**
Isolierkanne
Pot isolant

Edelstahl matt, doppelwandig isoliert, spülmaschinenfest, Santoprene-Versiegelung, ideal für thermische Desinfektion
Acier inoxydable mat, isolation à double paroi, lavable en machine, joint en Santoprene, idéal pour la désinfection thermique





8275.12000 100 cl   73.85

Aellos

**WAVE PUSH MINI**
Isolierkanne 0,6 L
Cruche isolante 0,6 L

Kunststoff, mit Qualitätsglaseinsatz, spülmaschinenfest durch Santoprene-Versiegelung, mit Druckastensverschluss für Einhandbedienung.

Matière plastique, avec intérieur en verre de qualité, garantie au lave-vaisselle grâce à l'isolation santoprene, avec bouton de verrouillage pour une utilisation d'une seule main.

8275.00300 weiss/blanc   35.158275.00301 schwarz/noir   35.158275.00302 vanille/vanille   35.158275.00303 rot/rouge   35.158275.00304 blau/bleu   35.158275.00305 cappuccino/cappuccino   35.158275.00306 kiwi/kiwi   35.15

Ersatzdeckel | Couvercle seul





*STO2934...   10.55

Aellos

**WAVE PUSH**
Isolierkanne 1 L
Cruche isolante 1 L

Kunststoff, mit Qualitätsglaseinsatz, spülmaschinenfest durch Santoprene-Versiegelung, mit Druckastensverschluss für Einhandbedienung.

Matière plastique, avec intérieur en verre de qualité, garantie au lave-vaisselle grâce à l'isolation santoprene, avec bouton de verrouillage pour une utilisation d'une seule main.

8275.00200 weiss/blanc   38.208275.00201 schwarz/noir   38.208275.00202 vanille/vanille   38.208275.00203 rot/rouge   38.208275.00204 blau/bleu   38.208275.00205 cappuccino/cappuccino   38.208275.00206 kiwi/kiwi   38.20

Ersatzdeckel | Couvercle seul





*STO2934...   10.55

Aellos

**WAVE PICCO**
Isolierkanne 30 cl
Cruche isolante 30 cl

Kunststoff, mit Qualitätsglaseinsatz, spülmaschinenfest durch Santoprene-Versiegelung.

Matière plastique, avec intérieur en verre de qualité, garantie au lave-vaisselle grâce à l'isolation santoprene.

8275.00030 weiss/blanc   31.708275.00031 schwarz/noir   31.708275.00032 vanille/vanille   31.708275.00033 rot/rouge   31.708275.00034 blau/bleu   31.708275.00035 cappuccino/cappuccino   31.708275.00036 kiwi/kiwi   31.70

Ersatzdeckel | Couvercle seul

*STO2944...   8.90

fello

**WAVE MINI****Isolierkanne 60 cl****Cruche isolante 60 cl**

Kunststoff, mit Qualitätsglaseinsatz, spülmaschinenfest durch Santoprene-Versiegelung.

Matière plastique, avec intérieur en verre de qualité, garantie au lave-vaisselle grâce à l'isolation santoprene.

8275.00050	weiss/blanc			33.50
8275.00051	schwarz/noir			33.50
8275.00052	vanille/vanille			33.50
8275.00053	rot/rouge			33.50
8275.00054	blau/bleu			33.50
8275.00055	cappuccino/cappuccino			33.50
8275.00056	kiwi/kiwi			33.50

Ersatzdeckel | Couvercle seul

*STO2944...			8.90
-------------	--	--	------

fello

**WAVE MINI S+****Isolierkanne 60 cl****Cruche isolante 60 cl**

Kunststoff, mit unzerbrechlichem Edelstahleinsatz, spülmaschinenfest durch Santoprene-Versiegelung.

Matière plastique, avec intérieur en inox incassable, garantie au lave-vaisselle grâce à l'isolation santoprene.

8275.00060	weiss/blanc			58.80
8275.00061	blau/bleu			58.80

Ersatzdeckel | Couvercle seul

*STO2944...			8.90
-------------	--	--	------

fello

**WAVE****Isolierkanne 1 L****Cruche isolante 1 L**

Kunststoff, mit Qualitätsglaseinsatz, spülmaschinenfest durch Santoprene-Versiegelung.

Matière plastique, avec intérieur en verre de qualité, garantie au lave-vaisselle grâce à l'isolation santoprene.

8275.00011	weiss/blanc			34.65
8275.00012	schwarz/noir			34.65
8275.00013	vanille/vanille			34.65
8275.00014	rot/rouge			34.65
8275.00015	blau/bleu			34.65
8275.00016	cappuccino/cappuccino			34.65
8275.00025	kiwi/kiwi			34.65

Ersatzdeckel | Couvercle seul

*STO2944...			8.90
-------------	--	--	------

fello

**WAVE S+****Isolierkanne 1 L****Cruche isolante 1 L**

Kunststoff, mit unzerbrechlichem Edelstahleinsatz, spülmaschinenfest durch Santoprene-Versiegelung.

Matière plastique, avec intérieur en inox incassable, garantie au lave-vaisselle grâce à l'isolation santoprene.

8275.00017	weiss/blanc			70.55
8275.00021	blau/bleu			70.55

Ersatzdeckel | Couvercle seul

*STO2944...			8.90
-------------	--	--	------

holloware

Aellos

**THERMOBOY****Isolierkanne 30 cl****Cruche isolante 30 cl**

Kunststoff, mit Qualitätsglaseinsatz, spülmaschinenfest durch Santoprene-Versiegelung.

Matière plastique, avec intérieur en verre de qualité, garantie au lave-vaisselle grâce à l'isolation santoprene.

8005.35571	beige/beige			30.55
8005.35572	weiss/blanc			30.55
8005.35573	rot/rouge			30.55
8005.35574	blau/bleu			30.55

Ersatzdeckel | Couvercle seul

*STO7341...			7.25
-------------	--	--	------

Aellos

**THERMOBOY****Isolierkanne 60 cl****Cruche isolante 60 cl**

Kunststoff, mit Qualitätsglaseinsatz, spülmaschinenfest durch Santoprene-Versiegelung.

Matière plastique, avec intérieur en verre de qualité, garantie au lave-vaisselle grâce à l'isolation santoprene.

8005.35575	beige/beige			30.55
8005.35576	weiss/blanc			30.55
8005.35577	rot/rouge			30.55
8005.35578	blau/bleu			30.55

Ersatzdeckel | Couvercle seul

*STO7341...			7.25
-------------	--	--	------

Aellos

**WASH****Isolierkanne 1 L****Cruche isolante 1 L**

Kunststoff, mit Qualitätsglaseinsatz, spülmaschinenfest durch Santoprene-Versiegelung.

Matière plastique, avec intérieur en verre de qualité, garantie au lave-vaisselle grâce à l'isolation santoprene.

8005.35565	weiss/blanc			32.30
8005.35566	grau/gris			32.30
8005.35567	vanille/vanille			32.30
8005.35568	rot/rouge			32.30
8005.35569	blau/bleu			32.30
8005.35570	schwarz/noir			32.30

Ersatzdeckel | Couvercle seul

*STO2744...			8.90
-------------	--	--	------

Aellos

**WASH S+****Isolierkanne 1 L****Cruche isolante 1 L**

Kunststoff, mit unzerbrechlichem Edelstahleinsatz, spülmaschinenfest durch Santoprene-Versiegelung.

Matière plastique, avec intérieur en inox incassable, garantie au lave-vaisselle grâce à l'isolation santoprene.

8275.00005	weiss/blanc			65.85
8275.00009	blau/bleu			65.85

Ersatzdeckel | Couvercle seul



*STO2764...			8.90
-------------	--	--	------

Aellos

COFFEESTATION
Pumpenkrug
Cruche pompe

doppelwandiger, vakuumgepumpter Edelstahl, dadurch bruchssichere Kanne. Pumpsystem aus Hartplastik, Pumphebel aus verchromten Stahl, durch drehbaren Boden ist die Kanne um 360° um die eigene Achse drehbar.

Double parois, inox, incassable, système de pompe en plastique dur, levier en acier chromé, fond pivotant sur 360°

8275.11000	2,5 L			117.25
8275.11001	3,5 L			139.90

Aellos

PIPE
Pumpenkrug
Cruche pompe

Sehr gute Warmhaltung durch doppelwandigen Edelstahlinsatz. Das Modell ist bruchssicher. Deckel, Henkel und Pumpsystem aus Kunststoff. Edelstahl-Mantel mattiert. Im Boden der Isolierkanne ist eine Drehvorrichtung eingearbeitet.

Très bonne rétention de la chaleur grâce à l'insert en acier inoxydable à double paroi. Le modèle est incassable. Couvercle, poignée et système de pompage en plastique. Gainage en inox mat. Un dispositif rotatif est intégré au fond de la cruche.

1762.39207	2,5 L			104.20
------------	-------	---	---	--------

Aellos

COFFEESTATION
Tropfen-Fänger
Bac de récupération

aus stabilem schwarzem Kunststoff, Abtropfgitter ist aus rostfreiem Edelstahl. Mehrere Tropfen-Fänger lassen sich miteinander verbinden oder mit der Service Station kombinieren. Einstellöffnung 15,5 cm en plastique noir résistant, grille-égouttoir en acier inoxydable

Possibilité de joindre entre eux plusieurs bacs de récupération ou de les combiner à la station Ouverture de réglage: 15,5 cm

8275.11004	18,7 x 24,5 x H 4,2 cm			24.90
------------	------------------------	---	---	-------

Aellos

COFFEESTATION
Service Station
Station Service

fünf verschiedene Fächer für Milch, Zucker, Kaffeebecher oder Teebeutel für einen perfekten Service rund um die Heissgetränkeversorgung mit Pump-Isolierkannen. Mehrere Service-Stationen lassen sich miteinander verbinden oder mit dem Tropfen-Fänger kombinieren. Cinq compartiments différents pour le lait, de thé, le sucre ou les gobelets à café afin d'accompagner à la perfection le service des boissons chaudes avec des thermos pompes. Possibilité de relier entre elles plusieurs stations de libre-service ou de les combiner avec le bac de récupération.

8275.11005	22,4 x 26,2 x H 10,5 cm			32.30
------------	-------------------------	---	---	-------

holloware

**Pumpenkrug
Cruche pompe**

Edelstahl satiniert, unzerbrechlicher Edelstahleinsatz, doppelwandig isoliert, Antitropfsystem, Einhandbedienung, nicht spülmaschinengeeignet.

Acier inoxydable satiné, réservoir incassable en acier inoxydable, isolation à double paroi, système stop-gouttes, utilisation à une seule main, non lavable en machine

8270.26500 4,5 L



84.55

Aellos

**MAXX
Getränkespender
Distributeur de boissons**

Ein doppelwandiger Edelstahlkörper sorgt für die überdurchschnittlich hohe Isolierleistung. Alle Edelstahlteile sind aus hochwertigem Chrom/ Nickelstahl, sämtliche Komponenten sind 100% geschmacksneutral. Inklusive praktischem Tragebügel, tropffreiem Hahn, ausklappbaren Standbeinen. Un corps en acier inoxydable à doubles parois garantit une isolation très élevée. Toutes les pièces en acier inoxydable sont en acier chrome/ nickel de haute qualité et tous les composants sont neutres de goût. Inclusif anse pratique, robinet anti-goutte, trois pieds déliants.

8275.10000 6 l



324.65

8275.10001 10 l



343.50

Ersatz-Hahn/Robinet de rechange

8275.10005



19.75

**THEOS
Pumpenkrug
Cruche pompe**

Pumpenkrug mit Chromstahlhülle, Hartglas-Einsatz, Metall-Pumpenhebel

Airpot avec gaine en inox, verre extra dur, levier à pression métallique

8005.35530 1,9 L



152.90

8005.35531 2,5 L



178.80

8005.35532 3,0 L



191.70

**Reinigungstabs, 25 Stück
Tabs de débouillage, 25 pcs**

Zum zuverlässigen Entfernen von hartnäckigen Verkrustungen durch Kaffee und Tee in allen Isolierkannen mit Glaskolben und Edelstahlkannen. Verhindert nachhaltig die Bildung von Keimen und Bakterien. Alle 8 - 12 Wochen eine Grundierung.

pour éloigner des restes de café et de thé dans tous les pots isolants avec ballon et pots en acier inoxydables. Préviend durable la constitution de germes et bactéries. Toutes les 8-12 semaines une couche d'impression.

8275.00100



23.50

**ARARE**

Teekanne aus Gusseisen

Théière en fonte

Lieferung inklusive Untersetzer und herausnehmbarem Teesieb.

Livré avec dessous et passoire à thé amovible.

1,5 L

640-09000	silber/argent			79.35
640-08000	weiss/blanc			79.35

**ARARE**

Teekanne aus Gusseisen

Théière en fonte

Lieferung inklusive Untersetzer und herausnehmbarem Teesieb.

Livré avec dessous et passoire à thé amovible.

1,2 L

640-07000	schwarz/noir			79.35
640-06000	schwarz-gold/noir-or			79.35
640-05000	kupfer/cuivre			79.35
640-40000	grün-gold/vert-or			79.35
640-41000	natur-iron/iron-naturelle			79.35

**ARARE**

Teekanne aus Gusseisen

Théière en fonte

Lieferung inklusive Untersetzer und herausnehmbarem Teesieb.

Livré avec dessous et passoire à thé amovible.

0,6 L

640-02000	schwarz/noir			63.50
640-42000	grün/vert			63.50

**ARARE**

Teekanne aus Gusseisen

Théière en fonte

Lieferung inklusive Untersetzer und herausnehmbarem Teesieb.

Livré avec dessous et passoire à thé amovible.

0,4 L

640-01000	schwarz/noir			56.50
-----------	--------------	--	--	-------

holloware

**BUN**
Teekanne aus Gusseisen
Théière en fonte

Lieferung inklusive Untersetzer und herausnehmbarem Teesieb.
Livré avec dessous et passoire à thé amovible.
0,5 L

640-11000 braungold/or-brun   67.50

**SO MATSU**
Teekanne aus Gusseisen
Théière en fonte

Lieferung inklusive Untersetzer und herausnehmbarem Teesieb.
Livré avec dessous et passoire à thé amovible.
1,0 L

640-18000 schwarz/noir   79.35
640-19000 rot/rouge   79.35







**NABE**
Teekanne aus Gusseisen
Théière en fonte

Lieferung inklusive Untersetzer und herausnehmbarem Teesieb.
Livré avec dessous et passoire à thé amovible.
0,5 L

640-16000 schwarz/noir   63.50
640-17000 grau/gris   63.50

**KAMBIN**
Teekanne aus Gusseisen
Théière en fonte

Lieferung inklusive Untersetzer und herausnehmbarem Teesieb.
Livré avec dessous et passoire à thé amovible.
1,0 L

640-12000 gold/or   79.35
640-13000 silberschwarz/noir-argent   79.35
640-47000 schwarz-gold/noir-or   79.35

**YOJO****Teekanne aus Gusseisen**
Théière en fonteLieferung inklusive Untersetzer und herausnehmbarem Teesieb.
Livré avec dessous et passoire à thé amovible.
0,9 L

640-43000	schwarz-gold/noir-or			74.75
640-44000	blau-gold/bleu-or			74.75
640-45000	grün-gold/vert-or			74.75
640-46000	grau-gold/gris-or			74.75

**TAWA****Teekanne stapelbar aus Gusseisen**
Théière empilable en fonteLieferung inklusive herausnehmbarem Teesieb.
Livré avec passoire à thé amovible.
0,5 L

640-30000	schwarz/noir			67.50
-----------	--------------	--	--	-------

**CHISANA CHI****Teekanne aus Gusseisen**
Théière en fonteLieferung inklusive herausnehmbarem Teesieb.
Livré avec passoire à thé amovible.
0,9 L

640-48000	schwarz/noir			68.75
640-49000	kupfer/cuivre			68.75

**Eisencup**
Cup en fonte
15 cl



640-60000	rot/rouge			13.25
640-61001	schwarz/noir			13.25
640-62002	orange			13.25
640-63003	blau/bleu			13.25
640-64004	grün/vert			13.25
640-65005	hellgrün/vert claire			13.25
640-66006	grau/gris			13.25
640-67007	hellblau/blau claire			13.25
640-68008	gold/or			13.25
640-69009	weiss/blanc			13.25
640-69010	petrol			13.25





tabletop



CLASSIC
Zuckergestell 4-tlg.
Service à sucre, en 4 parties



Cromargan®
06.3186.6040 H 21 cm   269.00

Ersatz-Porzellaneinsatz/Insert en porcelaine de rechange
60.3099.9990 Ø 8 cm x H 6,7 cm   13.95

Versilbert auf Anfrage | Argenté sur demande





CLASSIC
Porzellaneinsatz
Insert en porcelaine

60.3099.9990 Ø 8 cm x H 6,7 cm   13.95





Relish-Pickles-Gestell
Service à relish

Cromargan®
06.2829.6040 Ø 8 cm x H 13 cm   115.45



URBAN
Petit-Fours-Ständer
Porte petits fours

Cromargan®
55.0067.6040 Ø 15 cm x H 8,7 cm   69.80



URBAN
Mokkaétagère
Porte petits fours



Cromargan®
55.0066.6040 Ø 20 cm x H 13,3 cm   98.90

tabletop

WMF



CLASSIC
Petits-Fours-Ständer
Porte petits fours



Cromargan®
06.4379.6040 Ø 15,5 cm x H 13 cm   152.70

Versilbert auf Anfrage | Argenté sur demnade

WMF



SCALA
Brotschale
Panier à pain

Cromargan®
06.6380.6040 28 cm x 17 cm   46.85

WMF







NEUTRAL
Universalschale
Coupe universelle
Ø innen 12 cm
Ø interne 12 cm

Cromargan®
06.1849.6040 0,2 L   18.35

ALESSI



Brotkorb
Corbeille

Inox
8005.04580 Ø 15 cm x H 5 cm   58.80
8005.04581 Ø 20 cm x H 5 cm   82.10











Tischkorb
Corbeille de table
stapelbar, spülmaschinenfest
empilable, compatible au lave-vaisselle

Inox
8005.00427 20 x 15 cm Oval/ovale   21.15
8005.00415 Ø 17 cm Rund/ronde   21.15











Brottasche
Corbeille à pain
aus robustem Kraftpapier
en papier kraft robuste

8582.30440	Ø 17 cm x H 11 cm			11.25
8582.30450	Ø 20 cm x H 13 cm			11.70
8582.30442	Ø 24 cm x H 24 cm			18.80
8582.30443	Ø 30 cm x H 22 cm			22.30







Brottasche
Corbeille à pain
aus robustem Kraftpapier
en papier kraft robuste

8582.30441	Ø 17 cm x H 11 cm			11.25
8582.30451	Ø 20 cm x H 13 cm			11.70
8582.30445	Ø 24 cm x H 24 cm			18.80
8582.30446	Ø 30 cm x H 22 cm			22.30







Brottasche rund
Corbeille à pain rond
schmutzabweisende Kunstfaser, 30°C waschbar, wendbar
fibre synthétique anti-salissante, lavable à 30°C, reversible

8582.30345	Ø 17 cm x H 11,5 cm			11.70
8582.30346	Ø 20 cm x H 13,5 cm			15.25





Brottasche eckig
Corbeille à pain rectangulaire
schmutzabweisende Kunstfaser, 30°C waschbar, wendbar
fibre synthétique anti-salissante, lavable à 30°C, reversible

8582.30347	19 x 11 cm x H 10,5 cm			14.30
8582.30348	24 x 16 cm x H 10,5 cm			17.40



CLASSIC
Butterkühler
Refrâichisseur à beurre

Cromargan®	06.1090.6040	Ø 5,5 cm x H 8 cm			46.85
------------	--------------	-------------------	---	---	-------

Versilbert auf Anfrage | Argenté sur demande

tabletop



sambonet

SPHERA
 Universalschale
 Bol universel

Mit Griff | Avec anse

56591-24 Ø 24 cm



85.70

Ohne Griff | Sans anse

56591-25 Ø 24 cm



85.70

Silikonmatte | Tapis silicone

56591-54 Ø 24 cm



8.65

Versilbert auf Anfrage | Modèle argenté sur demande

sambonet

SPHERA
 Universalschale
 Bol universel

Mit Griff | Avec anse

56591-32 Ø 32 cm



164.00

Ohne Griff | Sans anse

56591-33 Ø 32 cm



164.00

Silikonmatte | Tapis silicone

56591-62 Ø 32 cm



15.20

Versilbert auf Anfrage | Modèle argenté sur demande

sambonet

SPHERA
 Tablett
 Plateau

Mit Griff | Avec anse

56595-40 Ø 40 cm



215.00

Silikonmatte | Tapis silicone

56595-70 Ø 40 cm



18.70

Versilbert auf Anfrage | Modèle argenté sur demande



**ATMOSFERA «Saturno»
Tablett
Plateau**

40 x 36 cm

631002007	Matic Bronze			115.80
631003008	Vulcan Grey			115.80
631001009	Matic Gold			115.80

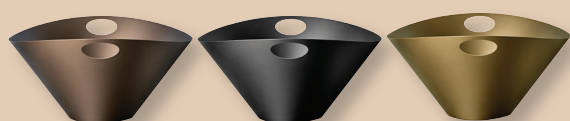

**ATMOSFERA «Venere»
Universalschale
Bol universel**

22 x 20 cm x H 11,5 cm

631002010	Matic Bronze			89.80
631003011	Vulcan Grey			89.80
631001012	Matic Gold			89.80

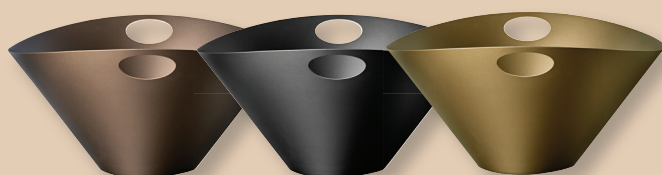

**ATMOSFERA «Venere»
Universalschale
Bol universel**

39 x 36 cm x H 17,5 cm

631002013	Matic Bronze			187.00
631003014	Vulcan Grey			187.00
631001015	Matic Gold			187.00



**SAPORI**

Die exklusiven, handgefertigten Produkte aus veganem Leder wurden speziell für die hohen Ansprüche der Hotellerie und Gastronomie gefertigt.

Wünschen Sie ein Tablett in einem besonderen Mass und Aussehen? Wählen Sie aus über 30 verschiedenen veganen Ledersorten und Modellen aus. Gerne beraten wir Sie.



SAPORI

Les produits exclusifs fabriqués à la main en cuir végétalien ont été spécialement conçus pour les exigences élevées de l'hôtellerie et de la restauration.

Voulez-vous un plateau avec une taille et une apparence spéciales? Choisissez de plus de 30 types et modèles de cuir végétalien différents. Nous nous ferons un plaisir de vous conseiller.



SAPORI
 Tablett mit Griffen
 Plateau avec poignées

Leder vegan
Cuir vegan

881-10011 50 x 35 cm x H 7 cm   98.70



SAPORI
 Tablett schwarz
 Plateau noir

Leder vegan
Cuir vegan

881-10013 50 x 34 cm x H 3 cm   76.35



SAPORI
 Tablett rund
 Plateau rond











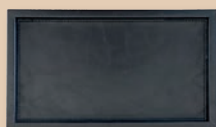

Holzrahmen, Leder vegan
Cadre bois, cuir vegan

881-10012 Ø 38,5 cm x H 2,5 cm   76.35

SAPORI
 Tablett quadratisch
 Plateau carrée

Holzrahmen, Leder vegan
Cadre bois, cuir vegan

881-10007 25 x 25 cm x H 2 cm   51.65

**SAPORI**
Tablett quadratisch
Plateau carréeHolzrahmen schwarz, Leder vegan
Cadre bois noir, cuir vegan881-10005 25 x 25 cm x H 2 cm   51.65**SAPORI**
Tablett rechteckig
Plateau rectangulaireLederrahmen schwarz, Leder vegan
Cadre cuir noir, cuir vegan881-10006 28 x 16 cm x H 2 cm   51.65**SAPORI**
Tablett
PlateauLeinen, antrazit
Lin, anthracite881-10014 23 x 14 x H 2 cm   23.35Leinen, olive
Lin, olive881-10015 23 x 14 x H 2 cm   23.35**SAPORI**
Notizbuch mit Block
Cahier de notesBraun
Brun881-10008 15 x 9 cm x H 1 cm   34.00**SAPORI**
Rechnungshalter mit Fach
Port-facture avec pocheLeder vegan, braun
Cuir vegan, brun881-10009 24,5 x 14 x H 2 cm   45.85

tabletop

SAPORI
Welcome-Tablett
Plateau welcome

taupe					
881-10050	36 x 36 cm x H 3 cm				58.55
braun/brun					
881-10051	36 x 36 cm x H 3 cm				58.55

SAPORI
Welcome-Tablett
Plateau welcome

taupe					
881-10052	50 x 40 cm x H 3 cm				69.80
braun/brun					
881-10053	50 x 40 cm x H 3 cm				69.80

SAPORI
Sachet-Halter zu Welcome-Tablett
Support sachets pour plateau welcome

taupe					
881-10054	15,5 x 10,5 cm x H 4 cm				41.15
braun/brun					
881-10055	15,5 x 10,5 cm x H 4 cm				41.15

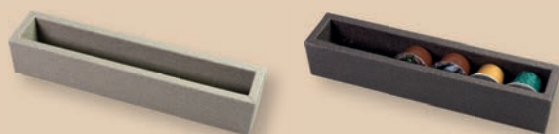
SAPORI
Kapsel-Halter zu Welcome-Tablett
Support capsules pour plateau welcome

taupe					
881-10056	23 x 4,5 cm x H 4 cm				35.05
braun/brun					
881-10057	23 x 4,5 cm x H 4 cm				35.05

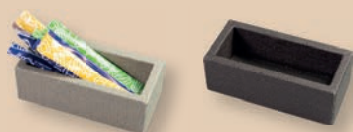
SAPORI
Kapsel-Halter zu Welcome-Tablett
Support capsules pour plateau welcome

taupe					
881-10058	12 x 5,5 cm x H 4 cm				29.35
braun/brun					
881-10059	12 x 5,5 cm x H 4 cm				29.35

**Kreidetafel****Tableau**

Rahmen aus dreifach lackiertem Buchenholz, Teak-farbig, mit Tafel aus schwarzem PVC-Kunststoff, wetterfest, Tafel und Rahmen sind sehr gut zu reinigen, schwere hochwertige Qualität

Cadre en bois de hêtre triple vernis, couleur teak, avec panneau en plastique PVC noir, résistant aux intempéries, tableau noir et cadre très faciles à nettoyer, qualité lourde

7072.00301	60 x 80 cm			115.85
7072.00302	70 x 90 cm			156.40
7072.00303	56 x 120 cm			132.90

**Kreidetafel****Tableau noir**

Rahmen aus schwarz lackiertem Buchenholz, wetterfest, Tafel und Rahmen sind sehr gut zu reinigen, geeignet zur Wandmontage oder für Staffelei, mittelschwere Qualität

Cadre en chêne laqué noir, avec panneau en plastique PVC noir, résistant aux intempéries, tableau et cadre sont très faciles à nettoyer, adapté à un montage mural ou sur chevalet, qualité moyenne

7072.00400	30 x 40 cm			28.55
7072.00401	40 x 60 cm			34.65
7072.00402	60 x 80 cm			46.90

**Flüssigkreidemarker schmal, 4er Set****Marqueur à craie, set à 4**

1-2 mm Schriftbreite, wasserlöslich, zum Beschriften von glatten Oberflächen, z.B. Glas, Plastik, Metalltafeln, Kreidetafeln

Marqueur à craie liquide pour tableaux et chevalets. Ainsi utilisable sur verre, métal et céramique. Laisser sécher après l'inscription











8005.03741	weiss/blanc			18.60/Set
------------	-------------	---	---	-----------

(3.45 p.pc)

**Flüssigkreidemarker****Marqueur à craie**

2-6 mm Schriftbreite, wasserlöslich, zum Beschriften von glatten Oberflächen, z.B. Glas, Plastik, Metalltafeln, Kreidetafeln













Marqueur à craie liquide pour tableaux et chevalets. Ainsi utilisable sur verre, métal et céramique. Laisser sécher après l'inscription

8005.03714	weiss/blanc			4.60
8005.03715	rot/rouge			4.60
8005.03716	blau/bleu			4.60
8005.03717	gelb/jaune			4.60
8005.03718	grün/vert			4.60
8005.03719	rosa/rosé			4.60
8005.03720	violett/lila			4.60

**Flüssigkreidemarker, breit****Marqueur à craie**

7-15 mm Schriftbreite, wasserlöslich, zum Beschriften von glatten Oberflächen, z.B. Glas, Plastik, Metalltafeln, Kreidetafeln

Marqueur à craie liquide pour tableaux et chevalets. Ainsi utilisable sur verre, métal et céramique. Laisser sécher après l'inscription



8005.03721	weiss/blanc			8.20
8005.03722	rot/rouge			8.20
8005.03723	blau/bleu			8.20
8005.03724	gelb/jaune			8.20
8005.03725	grün/vert			8.20
8005.03726	rosa/rosé			8.20

tabletop

sambonet



BAMBOO
Rechnungstablett
Plateau à monnaie

Inox
56718-22 22 x 14 cm   46.90

Versilbert auf Anfrage | Modèle argenté sur demande

sambonet



LINEA
Rechnungstablett
Plateau à monnaie

Inox
66318-29 19 x 14 cm   16.35

sambonet



LINEA
Rechnungstablett mit Mappe
Ensemble porte note/plateau

Inox
66318-39 20 x 16 cm   62.25



Klemmbrett-Rechnungshalter
Porte-bloc support d'addition







7072.00210 26,5 x 11,5 cm   10.55



Klemmbrett-Menukarte
Porte-bloc carte de menu

7072.00211 33 x 23 cm A4   17.40

Klemmbrett-Menukarte
Porte-bloc carte de menu

8006.95810	23 x 34,5 cm	A4	 	17.60
8006.95811	34,5 x 14 cm	1/2 A4	 	10.55
8006.95812	17 x 25 cm	A5	 	8.90









Klemmbrett-Menukarte
Porte-bloc carte de menu

8006.95815	23 x 34,5 cm	A4	 	17.60
------------	--------------	----	---	-------





PURE
Speisekartenhalter
Porte menu

Cromargan®				
06.7813.6040	H 7,5 cm		 	31.50

Bankettkartenständer
Support pour carte banquet

Inox				
8005.03409	Ø 8 cm x H 10 cm		 	11.70
8005.03410	Ø 8 cm x H 19 cm		 	14.80
8005.03411	Ø 8 cm x H 29 cm		 	15.95
8005.03435	Ø 8 cm x H 46 cm		 	17.95













Tischabfalleimer mit Schwingdeckel
Poubelle de table avec couvercle basculant

Inox				
8582.00027	Ø 10 cm x H 13 cm		 	21.15
8005.00401	Ø 12 cm x H 17 cm		 	27.75





Tischnummerschild inox, 12er Set
Numéro de table inox, set à 12

5,3 x 3,4 cm

8006.93201	Set Nr./No 1-12	 	35.40/Set
8006.93202	Set Nr./No 13-24	 	35.40/Set
8006.93203	Set Nr./No 25-36	 	35.40/Set
8006.93204	Set Nr./No 37-48	 	35.40/Set
8006.93205	Set Nr./No 49-60	 	35.40/Set
8006.93206	Set Nr./No 61-72	 	35.40/Set







Tischschild inox «Nichtraucher», 2er Set
Chevallet de table inox «Non fumer», set à 2

8582.00572 5,2 x 4,2 cm x H 3,5 cm   9.35/Set



Tischschild Inox, 2er Set
Chevallet de table inox, set à 2

Reserviert			
8005.03460	5,2 x 4,2 cm x H 3,5 cm	 	6.95/Set
Reserved			
8582.00013	5,2 x 4,2 cm x H 3,5 cm	 	6.95/Set



Untersetzer Inox
Sous-plat
6 Stück für Gläser
6 pièces pour verres

8582.35711 Ø 10 cm   29.40/Set





Untersetzer Inox
Sous-plat
6 Stück für Flaschen
6 pièces pour bouteilles

8582.35912 Ø 12 cm   27.00/Set



sambonet

**MARCO POLO**
Ess-Stäbchen Ablage
Pose baguettes56541-00 9 x 2,5 cm   11.70



sambonet

**SPHERA**
Serviettenring
Porte servietteInox
56994-00 Ø 5 cm x H 3,5 cm   22.25

sambonet

**SPHERA**
Windlicht
Lampe à bougieInox
56597-12 Ø 12 cm x H 13 cm   76.35Ersatzglas | Verre de rechange
56597-AA Ø 10 cm   25.75

sambonet

**SPHERA**
Windlicht
Lampe à bougieInox
56597-24 Ø 24 cm x H 17 cm   116.20Ersatzglas | Verre de rechange
56597-AB Ø 20 cm   44.55

sambonet

**BAMBOO**
Windlicht
Lampe à bougieInox
56774-17 Ø 10 cm   89.80

tabletop

WMF

PURE
Leuchter
Chandelier

Cromargan®
 06.4751.6040 H 10.5 cm   22.90

WMF



PURE
Windlicht, matt
Chandelier avec verrine, mat
 teilmattiert, ohne Kerzen. Für Teelichter
 partie dépolie, sans bougies. Pour bougies à chauffe-plat

Cromargan®
 06.8208.6040 H 21 cm   46.80

Ersatzglas/Verre de rechange
 60.3052.9990   25.85

WMF

URBAN
Windlicht
Lampe à bougie

Cromargan®
 55.0070.6040 Ø 8 cm x H 13,5 cm   29.25

Ersatzglas | Verre de rechange
 55.0070.9990 Ø 8 cm   14.80



WMF

PURE
Blumenvase
Vase à fleurs
 teilmattiert
 partiellement maté

Cromargan®
 06.7955.6040 H 20 cm   26.90

WMF

URBAN
Blumenvase
Vase à fleurs

Cromargan®
 55.0061.6040 Ø 7cm x H 17,5 cm   46.80

point
virguleLAMA ZÈRE
Teelicht
Boigeoir

Graublau Gris-bleu	880-60000	Ø 9 cm x H 9,3 cm			6.95
----------------------	-----------	-------------------	--	--	------

Salbeigrün Vert sauge	880-60100	Ø 9 cm x H 9,3 cm			6.95
-------------------------	-----------	-------------------	--	--	------

Mokka Mocca	880-60200	Ø 9 cm x H 9,3 cm			6.95
---------------	-----------	-------------------	--	--	------

point
virguleLAMA ZÈRE
Teelicht
Boigeoir

Graublau Gris-bleu	880-60300	Ø 10,5 cm x H 7,7 cm			6.95
----------------------	-----------	----------------------	--	--	------

Salbeigrün Vert sauge	880-60400	Ø 10,5 cm x H 7,7 cm			6.95
-------------------------	-----------	----------------------	--	--	------

Mokka Mocca	880-60500	Ø 10,5 cm x H 7,7 cm			6.95
---------------	-----------	----------------------	--	--	------

point
virguleLAMA ZÈRE
Vase/Windlicht
Vase/Photophore

Graublau Gris-bleu	880-60600	Ø 17,7 cm x H 18 cm			24.90
----------------------	-----------	---------------------	--	--	-------

Salbeigrün Vert sauge	880-60700	Ø 17,7 cm x H 18 cm			24.90
-------------------------	-----------	---------------------	--	--	-------

Mokka Mocca	880-60800	Ø 17,7 cm x H 18 cm			24.90
---------------	-----------	---------------------	--	--	-------

point
virguleLAMA ZÈRE
Vase/Windlicht
Vase/Photophore









Graublau Gris-bleu	880-60900	Ø 24,5 cm x H 28 cm			51.70
----------------------	-----------	---------------------	--	--	-------

Salbeigrün Vert sauge	880-61000	Ø 24,5 cm x H 28 cm			51.70
-------------------------	-----------	---------------------	--	--	-------

Mokka Mocca	880-61100	Ø 24,5 cm x H 28 cm			51.70
---------------	-----------	---------------------	--	--	-------



ménages

**CLASSIC**
Salz- und Pfeffergestell
Ménagère 2 piècesCromargan®
06.5171.6040 H 12,3 cm   115.85Ersatzteile | Pièces de rechange
06.6038.6040 Pfefferstreuer/Poivrière 13.25
06.6037.6040 Salzstreuer/Salière 13.25
60.6037.9990 Ersatzglas/Insert en porcelaine 13.25**Käsedose**
Fromagère
mit Kristalleinsatz
avec insert en cristalCromargan®
06.2868.6040 H 14,5 cm   69.80Ersatzteile | Pièces de rechange
06.1089.6043 Unterteller/Sous-assiette 27.50
06.2868.6042 Deckel/Couvercle 41.10
60.8025.9990 Ersatzglas/Insert en porcelaine 43.50**CLASSIC**
Parmesan-Menage mit Löffel
Ravier à parmesan avec cuillèreInox
8005.32100 Ø 10,5 cm x H 7 cm   28.55Ersatzglas | Verre de rechange
8005.32101   9.85**CLASSIC**
Parmesan-Menage mit Löffel
Ravier à parmesan avec cuillèreInox schwarz-matt/inox noir-mat
8582.40333 Ø 10,5 cm x H 7 cm   31.25Ersatzglas | Verre de rechange
8005.32101   9.85**Milch- und Zucker-Set 5-teilig**
Ravier à parmesan avec cuillère
Akazienholz, Edelstahl schwarz-matt (PTFE beschichtet)
Bois d'acacia, acier inoxydable noir-mat8582.00634 Ø 10,5 cm x H 7 cm   33.50



ménages



WMF



PURE
Salz- und Pfeffergestell
Ménagère 2 pièces
Kappen mattiert, Glas
Capuchons dépolis, verre

Cromargan®
06.5170.6040 H 14,5 cm   54.00



Ersatz-Pfefferstreuer | Poivrière de rechange
06.6063.6030 Ø 4 cm x H 11 cm   11.70

Ersatz-Salzstreuer | Salière de rechange
06.6062.6030 Ø 4 cm x H 11 cm   11.70

WMF





PURE
Pfefferstreuer
Poivrière
Kappen mattiert, Glas
Capuchons dépolis, verre

Cromargan®
06.6063.6030 Ø 4 cm x H 11 cm   11.70

WMF



PURE
Salzstreuer
Salière
Kappen mattiert, Glas
Capuchons dépolis, verre



Cromargan®
06.6062.6030 Ø 4 cm x H 11 cm   11.70

WMF



PURE
Essig-/Ölgestell
Huillier-vinaigrier
Kappen mattiert, Glas
Capuchons dépolis, verre

Cromargan®
06.1905.6040 H 21 cm   69.80

Ersatz-Flasche | Bouteille de huile ou vinaigre de rechange
06.6139.6030 Ø 4 cm   17.50

WMF





PURE
Einzelne Flasche komplett
Bouteille unique complète
Kappen mattiert, Glas
Capuchons dépolis, verre

Cromargan®
06.6139.6030 Ø 4 cm   17.50













PURE
Gestell Menage hoch
Porte-condiments profond

Cromargan®
06.2341.6045 Ø 14 cm x H 21 cm   53.85



PURE
Essig-/Ölgestell 4-tlg.
Huilier-vinaigrier, 4 parties













Cromargan®
06.2341.6040 Ø 14 cm x H 21,1 cm   145.80

Ersatzteil/ Pièce de rechange
06.2341.6045 Gestell hoch / Support haut   53.85
06.6139.6030 Flasche / Bouteille   17.50
06.6062.6030 Salzstreuer / Salière   11.70
06.6063.6030 Pfefferstreuer / Poivrière   11.70



PURE
Essig-/Ölgestell 3-tlg.
Huilier-vinaigrier, 3 parties

Artikel bitte einzeln bestellen
Veuillez commander les articles séparément

06.2341.6045 Gestell hoch / Support haut   53.85
06.6139.6030 Flasche / Bouteille   17.50
60.2506.9990 Glas S (VPE 6) / Verre S (UE 6)   3.50
06.2502.6040 Ring S (VPE 6) / Bague S (UE 6)   4.55
55.0031.6040 Deckel / Couvercle   6.95
54.9901.6040 Löffel / Cuillère   2.10





PURE
Zahnstocher
Porte-cure-dents
teilmatiert
partiellement maté

Cromargan®
06.8413.6040 H 7 cm   17.85



URBAN
Tablett
Plateau
auch geeignet als Besteckablage am Buffet
convient également comme porte-couvert au buffet



Cromargan®
55.0058.6045 23 cm x 10,7 cm   52.90

ménages



Luigi Bormioli
ITALY

OPTIMA

Öl-Flasche
Bouteille à huile

7081.70300 25 cl / 7,4 x 5 x H 14,3 cm   8.65

Essig-Flasche
Bouteille à vinaigre

7081.70301 25 cl / 7,4 x 5 x H 14,3 cm   8.65



Ersatzausgiesser | Verseur de rechange

7081.70500   4.55

Luigi Bormioli
ITALY

Öl-Flasche
Bouteille à huile

Borosilikat
Borosilicat

7081.20005 25 cl / Ø 9,1 cm x H 15,3 cm   19.70

AdHoc®



AROMA
Öl-/Essigspender
Distributeur d'huile/vinaigre



Edelstahl/Acryl, mit Dosiermechanismus
Inox/acrylique, avec dispositif de pompe

161015100 Ø 5,5 cm x H 23,5 cm   30.20



Senftöpfchen, 2er Set
Petit pot de moutarde, set à 2



inkl. Löffel und Edelstahl-Deckel
Cuillère et couvercle inox inclus

8582.40415 Ø 5 cm x H 6 cm   9.30
(4.65 p.pc)



DIAMOND

Pfeffermühle Acryl
Moulin à poivre en acryl

8582.40553 H 18 cm Ø 60 mm   25.75

Salzmühle Acryl
Moulin à sel en acryl

8582.40554 H 18 cm Ø 60 mm   25.75



☒ SchneidWerk®

Professionelle Köche schneiden Ihre Zutaten, damit sich auch die feinsten Nuancen der diversen Aromen in den unterschiedlichen Speisen verbreiten können. AdHoc hat jetzt ein besonderes Schneidwerk entwickelt, damit die Aromen der verwendeten Kräuter und Gewürze auch Ihre Küche bereichern und verfeinern können.

Das original AdHoc ☒ SchneidWerk® verfügt über spezielle Klingen aus Edelstahl mit geätzten messerscharfen Zähnen. Diese sind so gestaltet, dass getrocknete Kräuter und Gewürze zerschnitten statt gemahlen werden. So können sich ihre Aromen besser entfalten. Ein neues Genusslebnis!

☒ SchneidWerk®

Coupure comme un star a attribué le chef! les cuisiniers professionnels ont coupé leurs ingrédients afin de permettre même les nuances les plus fines des aromes divers pour répandre dans les différents plats. AdHoc a développé récemment un outil de coupe spécial qui le rend facile pour vous de raffiner votre propre cuisson et enrichissez-le avec les aromes de différentes herbes et épices.

L'original AdHoc ☒ SchneidWerk® est particulièrement conçu pour couper les herbes et les épices sèches avec une lame spéciale d'acier inoxydable comportant les dents brusquement gravées à l'eau-forte. Ainsi les herbes et les épices sèches peuvent dévoiler parfaitement leur arôme individuel. Une nouvelle sensation de goût!

AdHoc®



☒ SchneidWerk®

PEPE Chilischneider Trancheur de piments rouges

Edelstahl/Acryl, mit original SchneidWerk®
Inox/acrylique, avec l'original SchneidWerk®

160962100 Ø 4,5 cm x H 20,5 cm   30.20

«Bird's eye» Chili
«Bird's eye» Piments rouges

161058100 20 g   5.15



AdHoc®



☒ SchneidWerk®

VOYAGE Mini Chili- und Gewürzschneider Trancheur de piments rouges et d'épices

Edelstahl/Acryl, mit original SchneidWerk®
Inox/acrylique, avec l'original SchneidWerk®

161044100 Ø 3,8 cm x H 7,5 cm   27.50

ménages

AdHoc®

**AdHoc MÜHLEN
MOULINS AdHoc**
AdHoc-Ceramic-Mahlwerk

Ceramic hat einen höheren Härte- und Dichtegrad als Metall und ist daher verschleiß- und korrosionsfrei. Ceramic ist zudem geruchs- sowie geschmacksneutral und bringt das einzigartige Aroma frisch gemahlener Gewürze zur vollen Entfaltung. Auf das AdHoc-Ceramic-Mahlwerk geben wir 30 Jahre Garantie.

Mécanisme céramique AdHoc

La céramique est un matériau plus dur et plus dense que le métal et résiste dès lors parfaitement à l'usure et à la corrosion. De plus, la céramique est d'une neutralité gustative et olfactive totale et permet à l'arôme unique des épices fraîchement moulues de se développer pleinement. Le mécanisme céramique AdHoc est couvert par une garantie de 30 ans.

**SALT'N'PEPPER
Untersetzer aus Nussbaumholz
Sous-plat en noyer**

mit 2 Vertiefungen Ø 5 cm
avec 2 approfondissements Ø 5 cm

dunkel | foncé

191900000 17 x 8 cm, H 18 mm



19.50

hell | clair

191901000 17 x 8 cm, H 18 mm



19.50

**SALT'N'PEPPER
Menage
Ménagère**

Set bestehend aus Untersetzer und Salz- und Pfeffermühle (MP01)
Set composé de sous-plat avec moulin à poivre et sel (MP01)

dunkel | foncé

191909000 17 x 8 cm



61.15

hell | clair

191908000 17 x 8 cm



61.15

AdHoc®

**CLASSIC
Pfeffer- oder Salzmühle
Moulin à poivre ou sel**

Edelstahl/Acryl, Ceramic-Mahlwerk
Inox/acrylique, broyeur céramique



160018101 Ø 4,5 cm x H 13 cm



25.85

160022101 Ø 4,5 cm x H 18 cm





30.55

AdHoc®



MENAGE CLASSIC
Menage Salz/Pfeffer 3tlg
Menage poivre et sel 3-pcs

Edelstahl/Acryl/Akazienholz, Ceramic-Mahlwerk
Inox/acrylique/bois d'acacia, broyeur céramique



161211100 16 x 6 cm x H 13 cm   66.95

AdHoc®





MINIMILL
Pfeffer- oder Salzmühle
Moulin à poivre ou sel

Edelstahl/Acryl, Ceramic-Mahlwerk
Inox/acrylique, broyeur céramique

160026101 Ø 3,2 cm x H 6,2 cm   11.70

Set mit 2 Stück | Set à 2 pièces

160027101 Ø 3,2 cm x H 6,2 cm   23.50

AdHoc®



MENAGE MINIMILL
Menage Salz/Pfeffer 3tlg
Menage poivre et sel 3-pcs

Edelstahl/Acryl/Akazienholz, Ceramic-Mahlwerk
Inox/acrylique/bois d'acacia, broyeur céramique



161226100 9,2 x 4,5 cm x H 8,5 cm   38.80

AdHoc®



SERVE
Pfeffer- oder Salzmühle
Moulin à poivre ou sel

Edelstahl/Acryl, Ceramic-Mahlwerk
Inox/acrylique, broyeur céramique



161281100 Ø 5,4 cm x H 14,2 cm   15.05

AdHoc®



MENAGE SERVE
Menage Salz/Pfeffer 3tlg
Menage poivre et sel 3-pcs

Edelstahl/Kunststoff/Acryl, Ceramic-Mahlwerk,
Ständer spülmaschinenfest
Inox/plastique/acrylique, broyeur céramique,
support convient au lave-vaisselle

161280100 14,2 x 6,5 cm x H 16,5 cm   39.95

ménages

AdHoc®

MENAGE MOLTO
 Menage Salz/Pfeffer 3tlg
 Menage poivre et sel 3-pcs



 Edelstahl/Acryl/Akazienholz, Ceramic-Mahlwerk
 Inox/acrylique/bois d'acacia, broyeur céramique

 161240100 11,5 x 5,5 cm x H 9,5 cm   44.65

AdHoc®

SELECT
 Kurbelmühle für Pfeffer oder Salz
 Moulin à manivelle pour poivre ou sel

 Edelstahl/Acryl/Kunststoff, Ceramic-Mahlwerk
 Inox/acrylique/plastique, broyeur céramique

 161147100 Ø 8 cm x H 20 cm   44.15

AdHoc®

MENAGE CRYSTAL
 Menage Salz/Pfeffer 3tlg
 Menage poivre et sel 3-pcs



 Edelstahl/Acryl/Akazienholz, poliert klar, Ceramic-Mahlwerk
 Inox/acrylique/bois d'acacia, claire poli, broyeur céramique

 161274100 13,5 x 6,7 cm x H 17,5 cm   51.70

AdHoc®

MENAGE CRYSTAL
 Menage Essig/Öl 3tlg
 Menage huile/vinaigre 3-pcs

 Edelstahl/Acryl/Akazienholz, poliert klar, mit Dosiermechanismus
 Inox/acrylique/bois d'acacia, claire poli, avec dispositif de pompe



 161277100 13,5 x 6,7 cm x H 18,5 cm   51.70

AdHoc®



PEPMATIK
Elektrische Pfeffer- oder Salzmühle mit Licht
Moulin à poivre ou sel électrique avec lumière

Edelstahl/Acryl, Ceramic-Mahlwerk, inkl. 6 Batterien
Inox/acrylique, broyeur céramique, incl. 6 piles

160001101 Ø 5,0 cm x H 19 cm   49.35

Set mit 2 Stück | Set à 2 pièces

160003100 Ø 5,0 cm x H 19 cm   98.60

AdHoc®



EMILL
Elektrische Pfeffer- oder Salzmühle mit Licht
Moulin à poivre ou sel électrique avec lumière

Kunststoff/Edelstahl/Acryl, Ceramic-Mahlwerk, inkl. 6 Batterien
Plastique/inox/acrylique, broyeur céramique, incl. 6 piles

161337100 Ø 5,0 cm x H 21,5 cm   37.50

AdHoc®



EMILL
Elektrische Pfeffer- oder Salzmühle mit Licht
Moulin à poivre ou sel électrique avec lumière

Kunststoff/Edelstahl/Acryl, Ceramic-Mahlwerk, inkl. 6 Batterien
Plastique/inox/acrylique, broyeur céramique, incl. 6 piles

161338100 Ø 5,0 cm x H 21,5 cm   37.50

AdHoc®



EMILL
Elektrische Pfeffer- oder Salzmühle mit Licht
Moulin à poivre ou sel électrique avec lumière

Kunststoff/Edelstahl/Acryl, Ceramic-Mahlwerk, inkl. 6 Batterien
Plastique/inox/acrylique, broyeur céramique, incl. 6 piles

161339100 Ø 5,0 cm x H 21,5 cm   37.50

AdHoc®



EMILL
Elektrische Pfeffer- oder Salzmühle mit Licht
Moulin à poivre ou sel électrique avec lumière

Kunststoff/Edelstahl/Acryl, Ceramic-Mahlwerk, inkl. 6 Batterien
Plastique/inox/acrylique, broyeur céramique, incl. 6 piles



161340100 Ø 5,0 cm x H 21,5 cm   37.50

ménages

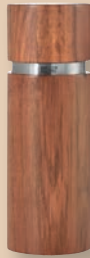
AdHoc®

PROFI
 Pfeffer- oder Salzmühle
 Moulin à poivre ou sel





Akazienholz, Ceramic-Mahlwerk, um ein vielfach gesteigertes Mahlergebnis gegenüber herkömmlichen Mühlen
 Bois d'acacia, broyeur céramique, résultat de broyage augmenté par rapport aux moulins traditionnels

161152100	Ø 6,5 cm x H 19 cm	 	44.65
-----------	--------------------	---	-------

AdHoc®

ACACIA
 Pfeffer- oder Salzmühle
 Moulin à poivre ou sel

Akazienholz, Ceramic-Mahlwerk
 Bois d'acacia, broyeur céramique

160043230	Ø 5 cm x H 14 cm	 	27.50
160044230	Ø 6 cm x H 17 cm	 	34.00

AdHoc®

AKASIA
 Pfeffer- oder Salzmühle
 Moulin à poivre ou sel











Edelstahl/Akazienholz/Glas, Ceramic-Mahlwerk
 Inox/bois d'acacia/verre, broyeur céramique

161241100	Ø 6,5 cm x H 13,5 cm	 	28.55
-----------	----------------------	---	-------

AdHoc®

IKON
 Pfeffer- oder Salzmühle
 Moulin à poivre ou sel







Akazienholz/Edelstahl, Ceramic-Mahlwerk
 Bois d'acacia/inox, broyeur céramique

161325100	Ø 5 cm x H 11,5 cm	 	31.70
161326100	Ø 5 cm x H 16 cm	 	39.95
161327100	Ø 6 cm x H 22 cm	 	42.30
161328100	Ø 6 cm x H 30 cm	 	58.80
161329100	Ø 6 cm x H 40 cm	 	98.55

AdHoc®

YONO
 Pfeffer- oder Salzmühle
 Moulin à poivre ou sel

Akazienholz, Ceramic-Mahlwerk
 Bois d'acacia, broyeur céramique

161377100	Ø 5,5 cm x H 12,7 cm	 	29.80
161330100	Ø 6,2 cm x H 15 cm	 	39.80
161331100	Ø 7,0 cm x H 18 cm	 	49.80

AdHoc®



YONO
Pfeffer- oder Salzmühle
Moulin à poivre ou sel

Eichenholz geölt hell, Ceramic-Mahlwerk
Chêne huile clair, broyeur céramique

161378100	Ø 5,5 cm x H 12,7 cm			39.80
161332100	Ø 6,2 cm x H 15 cm			46.80
161333100	Ø 7,0 cm x H 18 cm			58.70

AdHoc®



YONO
Pfeffer- oder Salzmühle
Moulin à poivre ou sel

Eichenholz geölt dunkel, Ceramic-Mahlwerk
Chêne huile foncée, broyeur céramique

161379100	Ø 5,5 cm x H 12,7 cm			39.80
161334100	Ø 6,2 cm x H 15 cm			46.80
161335100	Ø 7,0 cm x H 18 cm			58.70

AdHoc®



YOKO
Pfeffer-/Salzstreuer
Poivrier/Salière

Eichenholz geölt hell
Chêne huile clair

161380100	Ø 4,6 cm x H 7,5 cm			19.80
-----------	---------------------	--	--	-------

AdHoc®



YOKO
Pfeffer-/Salzstreuer
Poivrier/Salière

Eichenholz geölt dunkel
Chêne huile foncée

161381100	Ø 4,6 cm x H 7,5 cm			19.80
-----------	---------------------	--	--	-------

AdHoc®



YOKO
Set Pfeffer-/Salzstreuer
Set Poivrier/Salière

Eichenholz geölt
Chêne huile

161382100	Ø 4,6 cm x H 7,5 cm			39.80/Set
-----------	---------------------	--	--	-----------

ménages

AdHoc®

TEXTURA
 Set Pfeffer- und Salzmühle
 Set moulin à poivre et sel

 Eiche lackiert/Edelstahl, Ceramic-Mahlwerk CeraCut®
 Chêne laqué/inox, broyeur céramique CeraCut®

161148100	Ø 5,0 cm x H 15 cm			58.80/Set
161148101	Ø 5,9 cm x H 20 cm			79.90/Set

AdHoc®

TEXTURA
 Pfeffer- oder Salzmühle
 Moulin à poivre ou sel

 Holz/Edelstahl, Ceramic-Mahlwerk CeraCut®
 Bois/inox, broyeur céramique CeraCut®

161312100	Ø 5,0 cm x H 15 cm			30.20
161314100	Ø 5,9 cm x H 20 cm			39.95

AdHoc®

TEXTURA
 Pfeffer- oder Salzmühle
 Moulin à poivre ou sel

 Holz/Edelstahl, Ceramic-Mahlwerk CeraCut®
 Bois/inox, broyeur céramique CeraCut®

161313100	Ø 5,0 cm x H 15 cm			30.20
161315100	Ø 5,9 cm x H 20 cm			39.95

AdHoc®

TEXTURA ANTIQUE
 Pfeffer- oder Salzmühle
 Moulin à poivre ou sel

 Holz sandgestrahlt/Edelstahl, Ceramic-Mahlwerk CeraCut®
 Bois sablée/inox, broyeur céramique CeraCut®

161148105	Ø 5,0 cm x H 15 cm			30.20
161148106	Ø 5,9 cm x H 20 cm			39.95

AdHoc®

TEXTURA ANTIQUE
 Pfeffer- oder Salzmühle
 Moulin à poivre ou sel

 Holz sandgestrahlt/Edelstahl, Ceramic-Mahlwerk CeraCut®
 Bois sablée/inox, broyeur céramique CeraCut®



161148107	Ø 5,0 cm x H 15 cm			30.20
161148108	Ø 5,9 cm x H 20 cm			39.95

AdHoc®



TEXTURA
Set Pfeffer- und Salzmühle
Set moulin à poivre et sel

Eiche lackiert/Edelstahl, Ceramic-Mahlwerk CeraCut®
Chêne laqué/inox, broyeur céramique CeraCut®



161316100 Ø 5,0 cm x H 15 cm   67.00/Set

AdHoc®



TEXTURA
Pfeffer- oder Salzmühle
Moulin à poivre ou sel

Holz/Edelstahl, Ceramic-Mahlwerk CeraCut®
Bois/inox, broyeur céramique CeraCut®



161317100 Ø 5,0 cm x H 15 cm   34.05

AdHoc®



TEXTURA
Pfeffer- oder Salzmühle
Moulin à poivre ou sel

Holz/Edelstahl, Ceramic-Mahlwerk CeraCut®
Bois/inox, broyeur céramique CeraCut®



161318100 Ø 5,0 cm x H 15 cm   34.05

AdHoc®



DUOMILL MINI
Doppelmühle für Pfeffer und Salz
Moulin double pour poivre et sel

Edelstahl/Acryl, Ceramic-Mahlwerke
Inox/acrylique, broyeurs céramique





161124100 Ø 3,2 cm x H 11 cm   22.45

AdHoc®



DUOMILL PURE
Doppelmühle für Pfeffer und Salz
Moulin double pour poivre et sel

Edelstahl/Acryl, Ceramic-Mahlwerke
Inox/acrylique, broyeurs céramique

161238100 Ø 3,8 cm x H 15 cm   33.50
161146100 Ø 4,5 cm x H 22 cm   44.65



ménages

AdHoc®



SPIN
 Kreismühle für Pfeffer und Salz
 Moulin pour poivre et sel

Akazienholz/Kunststoff, Ceramic-Mahlwerk
 Bois d'acacia/plastique, broyeur céramique

161270100 Ø 8,5 cm x H 18,5 cm   44.55

AdHoc®



CAMO
 Mörser
 Pilon

Gusseisen/Akazienholz
 Fonte/bois d'acacia



161346100 Ø 6,5 cm x H 5 cm   26.95

AdHoc®



CAMO
 Mörser
 Pilon

Gusseisen/Akazienholz
 Fonte/bois d'acacia



161347100 Ø 8 cm x H 5 cm   31.65

AdHoc®



CAMO
 Mörser
 Pilon

Gusseisen/Akazienholz
 Fonte/bois d'acacia



161348100 Ø 10 cm x H 5 cm   34.00

AdHoc®



CAMO
 Mörser
 Pilon

Gusseisen/Akazienholz
 Fonte/bois d'acacia

161349100 Ø 6,5 cm x H 6 cm   26.95

AdHoc®

**CAMO.12**
Mörser
PilonGusseisen/Akazienholz
Fonte/bois d'acacia

161392100 Ø 12 cm x H 6 cm



43.50

AdHoc®

**ROCCA**
Mörser
PilonGusseisen/Akazienholz
Fonte/bois d'acacia

161350100 17 x 7,2 cm x H 10,7 cm



58.55

AdHoc®

**POTTA**
Gewürzdose
Boîte à épicesGusseisen/Akazienholz
Fonte/bois d'acacia

161351100 17 x 7,2 cm x H 4,5 cm



45.00

**BALI Cast Iron**
Gewürzset
Set d'épicesPfeffermühle aus Gusseisen mit passendem Salzbehälter aus
Gusseisen sowie Deckel und Löffel aus Bambus auf einem
Bambus-UntersetzerMoulin à poivre en fonte avec salière assortie en fonte ainsi que
couvercle et cuillère en bambou sur un support en bambou

8609.18000



139.80

ménages

**Pfeffermahlwerk**

Die mit einer Doppelreihe schräg ineinander greifender Zähne versehene Form führt die Pfefferkörner und blockiert sie während des Mahlens. Dieses einzigartige System gestattet es, den Mahlgrad durch einfaches Drehen des Knopfs auf der Mühle zu variieren: vom geschroteten bis zum fein gemahlene Pfeffer. Dieses Pfeffermahlwerk profitiert von einem patentierten Verfahren, das den Stahl vor Korrosion schützt und gleichzeitig dessen Schärfe und Beständigkeit im Gebrauch wahrt.

Salzmahlwerk

Das Peugeot-Mahlwerk ist für grobkörniges, trockenes Meersalz konzipiert. Aus rostfreiem Stahl gefertigt, ist es vor der Korrosion durch Salz geschützt.

Mécanisme à poivre

La forme agrémentée d'une double rangée de dents hélicoïdales guide les grains de poivre et les bloque lors du broyage. Ce système unique permet de faire varier la finesse de la mouture simplement en tournant le bouton situé sur le moulin: du poivre concassé au poivre très fin. Le mécanisme à poivre bénéficie d'un traitement breveté qui protège l'acier de la corrosion tout en gardant son tranchant et sa résistance à l'usure.

Mécanisme à sel

Le mécanisme Peugeot est conçu pour mouler du gros sel de mer sec. Réalisé en acier inoxydable, il est protégé de la corrosion saline.

**PARIS CHOCOLAT****Pfeffermühle Holz****Moulin à poivre en bois**

8609.10012	H 12 cm	Ø 55 mm			34.05
8609.10013	H 18 cm	Ø 56 mm			43.50
8609.10014	H 22 cm	Ø 60 mm			46.80
8609.10015	H 30 cm	Ø 68 mm			64.65
8609.10016	H 40 cm	Ø 77 mm			89.35
8609.10017	H 50 cm				151.70

Salzmühle Holz**Moulin à sel en bois**

8609.10042	H 12 cm	Ø 55 mm			34.05
8609.10043	H 18 cm	Ø 56 mm			43.50
8609.10044	H 22 cm	Ø 60 mm			46.80
8609.10045	H 30 cm	Ø 68 mm			64.65

**PARIS NATUREL****Pfeffermühle Holz****Moulin à poivre en bois**

8609.10000	H 12 cm	Ø 54 mm			34.05
8609.10001	H 18 cm	Ø 58 mm			43.50
8609.10002	H 22 cm	Ø 58 mm			46.80
8609.10003	H 30 cm	Ø 68 mm			64.65

Salzmühle Holz**Moulin à sel en bois**

8609.10025	H 12 cm	Ø 55 mm			34.05
8609.10026	H 18 cm	Ø 56 mm			43.50
8609.10027	H 22 cm	Ø 60 mm			46.80

**NANCY****Pfeffermühle Acryl****Moulin à poivre en acryl**

8609.11007	H 9 cm	Ø 53 mm			31.70
8609.11003	H 12 cm	Ø 55 mm			43.50
8609.11004	H 18 cm	Ø 59 mm			51.70
8609.11005	H 22 cm	Ø 60 mm			61.30

Salzmühle Acryl**Moulin à sel en acryl**

8609.21007	H 9 cm	Ø 53 mm			31.70
8609.21003	H 12 cm	Ø 55 mm			43.50
8609.21004	H 18 cm	Ø 59 mm			51.70
8609.21005	H 22 cm	Ø 60 mm			61.30



PARIS ANTIQUE

Pfeffermühle Holz, mit handgemachter antiker Patina

Moulin à poivre en bois, avec patine antique réalisée à la main

8609.10070	H 18 cm	Ø 58 mm			58.80
8609.10071	H 22 cm	Ø 58 mm			62.30

Salzmühle Holz, mit handgemachter antiker Patina

Moulin à sel en bois, avec patine antique réalisée à la main

8609.10080	H 18 cm	Ø 58 mm			58.80
8609.10081	H 22 cm	Ø 58 mm			62.30



BISTRO ANTIQUE

Pfeffermühle Holz, mit handgemachter antiker Patina

Moulin à poivre en bois, avec patine antique réalisée à la main

8609.10100	H 10 cm				39.95
------------	---------	--	--	--	-------

Salzmühle Holz, mit handgemachter antiker Patina

Moulin à sel en bois, avec patine antique réalisée à la main

8609.10200	H 10 cm				39.95
------------	---------	--	--	--	-------



PARIS OLIVIER

Pfeffermühle Olivenholz

Moulin à poivre en bois d'olivier

8609.16000	H 18 cm	Ø 58 mm			93.85
8609.16001	H 22 cm	Ø 58 mm			99.85

Salzmühle Olivenholz

Moulin à sel en bois d'olivier

8609.16020	H 18 cm	Ø 58 mm			93.85
8609.16021	H 22 cm	Ø 58 mm			99.85



BISTRO OLIVIER

Pfeffermühle Olivenholz

Moulin à poivre en bois d'olivier

8609.17000	H 10 cm				58.55
------------	---------	--	--	--	-------

Salzmühle Olivenholz

Moulin à sel en bois d'olivier

8609.17020	H 10 cm				58.55
------------	---------	--	--	--	-------



PARIS GRAPHITE

Pfeffermühle Holz, mit handgemachter antiker Patina

Moulin à poivre en bois, avec patine antique réalisée à la main

8609.15000	H 18 cm	Ø 58 mm			61.30
8609.15001	H 22 cm	Ø 58 mm			58.80
8609.15002	H 30 cm	Ø 68 mm			69.35

Salzmühle Holz, mit handgemachter antiker Patina

Moulin à sel en bois, avec patine antique réalisée à la main

8609.15020	H 18 cm	Ø 58 mm			61.30
8609.15021	H 22 cm	Ø 58 mm			58.80

ménages



Eingeschränkte Robustheit
robustesse limitée



FIDJI

Pfeffermühle Holz schwarz matt
Moulin à poivre en bois noir mat

8609.12012	H 12 cm	Ø 53 mm			42.30
8609.12004	H 15 cm	Ø 54 mm			56.40
8609.12005	H 20 cm	Ø 57 mm			69.35

Salzmühle Holz schwarz matt
Moulin à sel en bois noir mat

8609.12056	H 12 cm	Ø 53 mm			42.30
8609.12057	H 15 cm	Ø 54 mm			56.40
8609.12058	H 20 cm	Ø 57 mm			69.35



FIDJI

Pfeffermühle Olivenholz
Moulin à poivre en bois d'olivier

8609.12020	H 15 cm	Ø 54 mm			79.85
8609.12021	H 20 cm	Ø 57 mm			116.20

Salzmühle Olivenholz
Moulin à sel en bois d'olivier

8609.12025	H 15 cm	Ø 54 mm			79.85
8609.12026	H 20 cm	Ø 57 mm			116.20



Eingeschränkte Robustheit
robustesse limitée



TAHITI

Pfeffermühle Holz schwarz matt
Moulin à poivre en bois noir mat

8609.00000	H 15 cm	Ø 53 mm			39.95
8609.00001	H 20 cm	Ø 56 mm			61.30



BALI

Pfeffermühle Acryl (schwarz)
Moulin à poivre en acryl (noir)

8609.13010	H 8 cm				42.30
------------	--------	--	--	--	-------

Salzmühle Acryl (weiss)
Moulin à sel en acryl (blanc)

8609.13020	H 8 cm				42.30
------------	--------	--	--	--	-------



BALTIC

Pfeffermühle Acryl
Moulin à poivre en acryl

8609.14010	H 8 cm				42.30
------------	--------	--	--	--	-------

Salzmühle Acryl
Moulin à sel en acryl

8609.14020	H 8 cm				42.30
------------	--------	--	--	--	-------

**Trichter für Mühle****Entonnoir pour moulin**

Transparenter Universaltrichter zum effizienten befüllen von Pfeffer- und Salzmühlen.

Entonnoir universel transparent pour remplir efficacement les moulins à poivre et à sel

8006.95931 Ø 7,6 cm x H 5,7 cm



15.25

**WOODY****Holzbox****Base bois**

Akazienholz
Bois d'acacia

8582.11650 15 x 15 cm x H 5,5 cm



18.80

8582.11651 22,5 x 15 cm x H 5,5 cm



25.85

**TABLE****Holzbox****Base bois**

Akazienholz
Bois d'acacia

8582.11726 15 x 9,5 cm



15.05

**TABLE****Holzbox****Base bois**

Akazienholz, 3 Fächer
Bois d'acacia, 3 compartiments

8582.11727 23,5 x 8,5 cm



19.95

**SAPORI****Accessoires-Bag****Bag accessoires**

Leder vegan, braun
Cuir vegan, brun

881-10001 12 x 7 x H 12 cm



37.50

881-10002 17 x 10 x H 16 cm

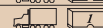

43.40

881-10003 21 x 12 x H 18 cm



51.65

881-10004 25 x 13 x H 19 cm



58.70



accessoires



Chafing Dish Löffel
Cuillère à chafing dish

Cromargan®

12.8387.6041 39 cm



18.95



Chafing Dish Löffel gelocht
Cuillère à chafing dish perforée

Cromargan®

12.8387.6042 39 cm



19.45



Chafing Dish Löffel
Cuillère à chafing dish

Cromargan®

12.8386.6041 26 cm



9.95



Chafing Dish Löffel gelocht
Cuillère à chafing dish perforée

Cromargan®

12.8386.6042 26 cm



9.95



Chafing Dish Gabel
Fourchette à chafing dish

Cromargan®

12.8249.6040 26 cm



9.95

accessoires

berndorf
LUZERN

HOLIDAY
Serviergabel
Fourchette à servir

Inox
0214060100 22,5 cm   10.50

berndorf
LUZERN

HOLIDAY
Servierlöffel
Cuillère à servir

Inox
0214058100 22,5 cm   10.50

WMF



Salatgabel
Fourchette à salade

Cromargan®
12.8343.6042 26 cm   11.50

WMF



NUOVA
Servierlöffel perforiert gross
Cuillère à servir perforée grand

Cromargan®
12.9161.6040 26 cm   17.50

WMF



NUOVA
Servierzange perforiert
Pince à servir perforée

Cromargan®
12.9733.6040 26 cm   19.80



NUOVA
Pastazange
Pince à pâtes

Cromargan®
12.9735.6040 25 cm



19.80



NUOVA
Universalzange
Pince de cuisine

Cromargan®
12.9732.6040 26,5 cm

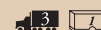

19.80



Universalzange
Pince de cuisine

Cromargan®
54.9906.6040 23 cm



12.50

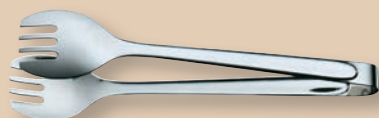

Salatzange
Pince à salade

Cromargan®
12.8341.6040 31 cm



26.65



Salatzange
Pince à salade

Cromargan®
12.8306.6040 30,5 cm



28.90

accessoires

WMF

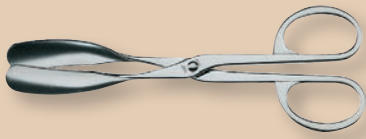

Gebäck - und Servierzange
Pince à gâteau

Cromargan®

12.8362.6040 17 cm



23.45

WMF



Eiszange
Pince à glace

Cromargan®

12.8307.6040 17,3 cm



9.95

WMF



Zuckerzange
Pince à sucre

Cromargan®

12.8342.6040 10,7 cm



4.65

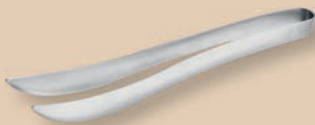

Gourmetpinzette
Pince à gourmet

Inox

8006.42604 18,5 cm



28.20

**Kaviarlöffel perlmutter**
Cuillère à caviar nacre41518-00 11,4 cm   26.40**Kaviarspatel perlmutter**
Spatule à caviar nacre41518-01 10,2 cm   39.80**Kaviargabel perlmutter**
Fourchette à caviar nacre41518-02 11,4 cm   34.60**Party-Löffel**
Cuiller à partyCromargan®
12.8993.6040 12,5 cm   6.75**Amuselöffel**
Cuillère amuse-boucheInox
49130994100 11,5 cm   4.45

accessoires

WMF



Hummergabel
Fourchette à homard

Cromargan®

12.8336.6041 24 cm



6.60

WMF



Hummerzange
Pince à homard

Cromargan®

12.8410.6040 19,8 cm



93.95

WMF



Schneckengabel
Fourchette à escargots

Cromargan®

12.8335.6040 14,5 cm



3.50

WMF



Schneckenzange
Pince à escargots

Cromargan®

12.8291.6040 15 cm



16.50



Schneckenzange
Pince aux escargots

Inox

49004013100 16 cm



5.75



CONTOUR
Austerngabel
Fourchette à huîtres

Cromargan®
12.0240.6040 13,6 cm   3.95



Tortenheber
Pelle à tarte

Cromargan®
12.8424.6040 26 cm   9.80



Dressinglöffel
Cuillère à vinaigrette

Cromargan®
12.8344.6040 40 cm   28.90



Portionsschöpfer
Louche petite

Cromargan®
12.8423.6040 24 cm   15.45



Suppenschöpfer
Louche grande

Cromargan®
54.9904.6040 29,5 cm   23.45

accessoires

**Universalzange**
Pince universel

Inox	8582.75850	19,5 cm			6.30
kupfer-look/couleur cuivre	8582.75851	19,5 cm			6.95
gunmetal/couleur gunmetal	8582.75852	19,5 cm			6.95

**Universalzange**
Pince universel

Inox	8582.75853	19,5 cm			6.30
kupfer-look/couleur cuivre	8582.75854	19,5 cm			6.95
gunmetal/couleur gunmetal	8582.75855	19,5 cm			6.95

berndorf
LUZERN**PROFILINE**
Brotmesser, Griff schwarz
Couteau à pain

Inox	10375192200	20 cm			14.50
------	-------------	-------	--	--	-------

berndorf
LUZERN**PROFILINE**
Brotmesser, Griff weiss
Couteau à pain

Inox	10375192201	20 cm			15.50
------	-------------	-------	--	--	-------

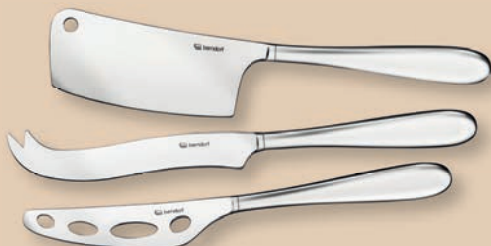
berndorf
LUZERN**Käsemesser Set 3 teilig, Hohlheft**
Set de couteaux à fromage 3 pcs, manche creux

Inox	0189099100				37.95
------	------------	--	--	--	-------

Käsebeil, Hohlheft

Trancheur à fromage manche creux	0189099130	21,2/10,5 cm			12.65
---	------------	--------------	--	--	-------

Käsemesser Hartkäse, Hohlheft

Couteau à fromage pâte dure, manche creux	0189099120	21,9/11,1 cm			12.65
--	------------	--------------	--	--	-------

Käsemesser Weichkäse, Hohlheft

Couteau à fromage pâte molle, manche creux	0189099110	23,2/12,4 cm			12.65
---	------------	--------------	--	--	-------



NUOVA
Käsemesser Set 2 teilig
Set de couteaux à fromage 2 pcs

Cromargan®
12.9178.6040



26.95



Premium Zesto Reibe
Premium zesteur râpe
für Käse, Zitrusfrüchte, Ingwer, Muskatnuss, etc.
pour le fromage, les agrumes, le gingembre, la noix de muscade, etc.

8006.42408 2,6 x 20,5 cm



35.15



CUISIPRO
Käsereibe
Moulin à fromage

Inox
8324.30015 20 cm



68.20



Käsehobel Holz lackiert
Rabot à fromage

Plantagenholz Hevea
hévéa plantation

8020.00066 10 x 30 cm x H 8,5 cm



34.65

8020.00067 15,5 x 35 cm x H 15 cm



50.55



Käseschaber
Appareil à râcler le fromage

8020.00065 Ø 22 cm



34.65

accessoires



Trüffelhobel
Râpe à truffe

Olivenbaumholz
Bois d'olivier

8020.00068 21 x 9 cm



66.95



Zitronenschnitzpresse
Presse citron

Inox
8102.14537



3.40



Teebox
Boîte à thé

Holzbox mit Sichtfenster, 4 Teebeutelächer
Boîte en bois avec lucarne, pour 4 compartiments à sachets

8006.60500 33,5 x 20 cm x H 9 cm



38.80



Kakaostreudose mit 4 Motiven
Saupoudreuse à cacao avec 4 motifs

8102.14964 Ø 7 cm x H 10,5 cm



38.80

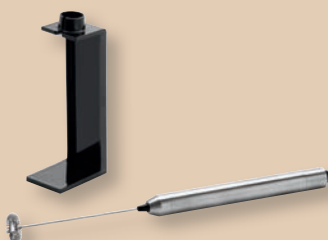

Milchaufschäumer
Mousseur à lait

schlankes Gehäuse aus Edelstahl, mit Ständer, leistungsstarker Motor, 13'000 U/Minute, mit 2 AAA-Batterien
Inox, comprend un support pratique

8102.18420 Ø 1,2 cm x H 25 cm



21.15



Teesieb mit Behälter 18/10
Passoire à thé 18/10, avec support



8006.50051 Ø 5,5 cm   17.40

AdHoc®



FLOATEA
Schwimmendes Tee-Ei
Boule à thé flottante

Edelstahl/Kunststoff, mit Kunststoffständer
Inox/plastique, avec support en plastique



160495100 Ø 4 cm x H 11 cm   9.75

AdHoc®



MRS. BEAN
Kaffeemühle
Moulin à café

Edelstahl/Acryl/Kunststoff, Ceramic-Mahlwerk
Inox/acrylique/plastique, broyeur céramique



161177100 Ø 6 cm x H 18 cm   58.55

AdHoc®



MR. BREW
Kaffeebereiter
Cafetière

Edelstahl/Kunststoff
Inox/plastique

161177105 Ø 13 cm x H 26,5 cm   46.80



service & buffet

**Butterkühler
refraichisseur à beurre
mit Unterteller
avec soucoupe**

Cromargan®

06.1089.6040 H 6,5 cm / Ø 14,5 cm



117.40

Ersatzteile | Pièces de rechange

06.1089.6043 Unterteller/Soucoupe

27.50

**CLASSIC
Butterkühler
Refräichisseur à beurre**Artikel bitte einzeln bestellen
Veuillez commander les articles séparément

Unterteil | Partie inférieure

06.3847.6041 0,1 L / Ø 12 cm



105.75

Einsatz | Utilisation

06.1082.6044 Einsatz / Utilisation



58.55

**CLASSIC
Kaviarkühler
Refräichisseur à caviar**Artikel bitte einzeln bestellen
Veuillez commander les articles séparément

Unterteil | Partie inférieure

06.3847.6041 0,1 L / Ø 12 cm



105.75

Einsatz | Utilisation

06.1082.6044



58.55

Einsatz | Utilisation

19.999.8617



16.40

**CLASSIC
Chillcup
Chillcup**Artikel bitte einzeln bestellen
Veuillez commander les articles séparément

Unterteil | Partie inférieure

06.3847.6041 0,1 L / Ø 12 cm



105.75

Ring | Anneau

06.3853.6045 Ø 12 cm



46.80

Glasschale | Bol en verre

19.999.8616



16.40

**Butterkühler
Refräichisseur à beurre**Artikel bitte einzeln bestellen
Veuillez commander les articles séparément

Unterteil | Partie inférieure

06.1849.6040 0,2 L / Ø 12 cm



18.35

Einsatz | Utilisation

06.1082.6044



58.55

service & buffet

**CLASSIC**
Tablett, rund
Plateau de service, rond

Cromargan®			
06.7260.6040	Ø 29,5 cm		62.90
06.7261.6040	Ø 35 cm		79.80
06.7262.6040	Ø 41,7 cm		88.10

Versilbert auf Anfrage | Argenté sur demande

**CLASSIC**
Tablett, oval
Plateau de service, ovale

Cromargan®			
06.7265.6040	51,6 cm x 39,3 cm		116.30

Tablett, oval
Plateau de service, ovale

Cromargan®			
06.7540.6040	22 cm x 15,5 cm		45.85
06.7542.6040	27 cm x 20 cm		55.90
06.7543.6040	29 cm x 22,5 cm		58.55

Tablett Gastronorm
Plateau de service Gastronorm

Cromargan®			
06.7658.6040	GN 1/2 - 32,2 cm x 26,5 cm		64.45
06.7660.6040	GN 1/1 - 53 cm x 32,5 cm		99.50
06.7661.6040	GN 2/1 - 65 cm x 53 cm		179.80

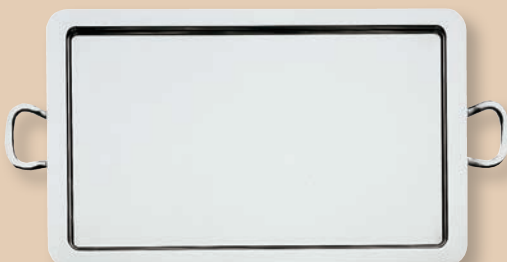
Tablett Gastronorm
Plateau de service Gastronorm
Masse ohne Griffe, rechteckig
Dimensions sans poignées, rectangulaire

Cromargan®			
06.8440.6040	GN 1/1 - 53 cm x 32,5 cm		159.80
06.8441.6040	GN 2/1 - 65 cm x 53 cm		298.00

**Tablett, rechteckig**
Plateau de service, rectangulaire

Cromargan

06.7585.6040	28,5 cm x 21 cm			48.75
06.7586.6040	33 cm x 26 cm			58.50
06.7588.6040	42,5 cm x 31,5 cm			93.85

sambonet

**ELITE**
Bratenplatte, oval
Plat ovale

Inox	Ø Ext.	Ø Int.			
56041-30	30 x 19 cm	24 x 13 cm			58.55
56041-35	35 x 22 cm	28 x 16 cm			69.80
56041-41	41 x 26 cm	34 x 19 cm			82.10
56041-46	46 x 29 cm	38 x 21 cm			93.85
56041-54	54 x 37 cm	43 x 26 cm			116.20

Versilbert auf Anfrage | Modèle argenté sur demande

sambonet

**ELITE**
Speiseglocke, oval
Cloche pour plat ovale
Passend zu Bratenplatte oval
Compatible avec Plat ovale

Inox				
56043-29	28 x 18 cm			164.00
56043-34	34 x 21 cm			188.00
56043-40	40 x 25 cm			198.80
56043-45	45 x 28 cm			258.55
56043-53	53 x 35 cm			305.60

Versilbert auf Anfrage | Modèle argenté sur demande

sambonet

**ELITE**
Untersetzer
Sous-plat

Inox	Ø	Ø			
56112-14	Ø 14 cm	Ø 9,5 cm			37.50
56112-17	Ø 17 cm	Ø 13 cm			38.70
56112-24	Ø 24 cm	Ø 16,5 cm			62.25

Versilbert auf Anfrage | Modèle argenté sur demande

**Tablett**
Plateau

Inox				
412071100	25 x 20 cm			31.65
412069100	36 x 29 cm			51.65
412065100	40 x 33 cm			55.90
412068100	48 x 37 cm			76.35

service & buffet



Kuchen-/Tortenplatte
Plat à tarte

Cromargan

06.4274.6040 Ø 36 cm / H 14,5 cm



139.80

sambonet



ELITE
Schneckenplatte
Plat aux escargots

Inox

56049-06 Ø 25 cm 6 pcs.



66.80

56049-12 Ø 31 cm 12 pcs.



76.35

Versilbert auf Anfrage | Modèle argenté sur demande

sambonet



ELITE
Gemüseschüssel mit Deckel
Légumier avec couvercle

Inox

56056-55 Ø 14,5 cm 55 cl



164.00

56056-58 Ø 17,5 cm 90 cl



187.00

56056-61 Ø 20,5 cm 140 cl



198.00

56056-65 Ø 25,0 cm 240 cl



234.50

Versilbert auf Anfrage | Modèle argenté sur demande

sambonet



ELITE
Suppenschüssel mit Deckel
Soupière avec couvercle

Inox

56054-52 Ø 12,0 cm 36 cl



164.00

56054-55 Ø 14,5 cm 80 cl



198.00

56054-58 Ø 17,5 cm 125 cl



234.50

56054-61 Ø 20,5 cm 180 cl



257.45

56054-65 Ø 25,0 cm 320 cl



279.00

Versilbert auf Anfrage | Modèle argenté sur demande

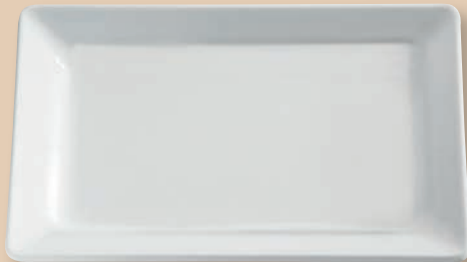
**PURE****Buffetplatte GN, Melamin
Plate à buffet GN, mélamine****Weiss | Blanc**

8582.83401	GN 1/1 - 53,0 x 32,5 cm			66.95
8582.83480	GN 1/2 - 32,5 x 26,5 cm			35.15
8582.83481	GN 1/3 - 32,5 x 17,5 cm			31.70
8582.83482	GN 1/4 - 26,5 x 16,2 cm			18.80
8582.83433	GN 2/4 - 53,0 x 16,2 cm			38.80

Schwarz | Noir

8582.83479	GN 1/1 - 53,0 x 32,5 cm			66.95
8582.83490	GN 1/2 - 32,5 x 26,5 cm			35.15
8582.83491	GN 1/3 - 32,5 x 17,7 cm			31.70
8582.83492	GN 1/4 - 26,5 x 16,2 cm			18.80
8582.83434	GN 2/4 - 53,0 x 16,2 cm			38.80

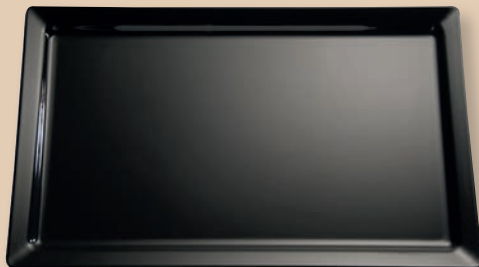
**Buffetplatte Bäckermaß, Melamin
Plate à buffet mesure de boulanger, mélamine****Weiss | Blanc**

8582.83597	40,0 x 30,0 cm			50.55
------------	----------------	--	--	-------

Schwarz | Noir

8582.83592	40,0 x 30,0 cm			50.55
------------	----------------	--	--	-------

**PURE****Buffetplatte rechteckig, Melamin
Plate à buffet rectangulaire, mélamine****Weiss | Blanc**

8582.83417	30,0 x 21,0 cm			25.85
8582.83403	35,5 x 18,0 cm			21.15
8582.83402	53,0 x 18,0 cm			42.30

**PURE****Buffetplatte quadratisch, Melamin
Plate à buffet carrée, mélamine****Weiss | Blanc**

8582.83418	18,0 x 18,0 cm			12.25
8582.83407	21,0 x 21,0 cm			17.40
8582.83406	26,5 x 26,5 cm			26.95
8582.83405	37,0 x 37,0 cm			37.60
8582.83404	51,0 x 51,0 cm			76.20

service & buffet



+90°C

PURE
 Schale quadratisch, Melamin
 Coupe carrée, mélamine

Weiss | Blanc

8582.83414	9 x 9 cm x H 6,5 cm			6	6.95
8582.83410	12,5 x 12,5 cm x H 6,5 cm			6	10.55
8582.83409	19,0 x 19,0 cm x H 9,0 cm			3	34.65
8582.83408	25,0 x 25,0 cm x H 12,0 cm			2	56.40

Schwarz | Noir

8582.83466	9 x 9 cm x H 6,5 cm			20	6.95
8582.83467	12,5 x 12,5 cm x H 6,5 cm			5	10.55
8582.83468	19,0 x 19,0 cm x H 9,0 cm			5	34.65
8582.83469	25,0 x 25,0 cm x H 12,0 cm			3	56.40

PURE
 Deckel mit Löffelaussparung
 Couvercle, avec encoche pour la louche

8582.83600	19 x 19 cm			6	12.25
8582.83601	25 x 25 cm			6	16.40

PURE
 Deckel, 5er Set
 Couvercle, set de 5
 Polypropylen, dichtschiessend, schwappsicherer Transport
 Polypropylène, fermeture hermétique, transport sans éclaboussures

8582.83603	13 x 13 cm			5	9.35/Set
<i>passend/compatible: 8582.83410 + 8582.83467</i>					
8582.83604	19,5 x 19,5 cm			5	10.55/Set
<i>passend/compatible: 8582.83409 + 8582.83468</i>					

PURE
 Menage 5tlg., Melamin
 Menage à 5 pcs., mélamine

Weiss Blanc					
8582.09923	17 x 17 cm x H 16 cm			1	44.65



GN-Behälter, Melamin

Bac-GN, mélamine

Weiss | Blanc

8582.83759	GN 1/1 - 32,5 x 53,0 x H 6,5 cm			50.55
8582.83757	GN 1/2 - 32,5 x 26,5 x H 6,5 cm			28.90
8582.83755	GN 2/4 - 16,2 x 53,0 x H 6,5 cm			33.50
8582.83753	GN 1/3 - 32,5 x 17,5 x H 6,5 cm			24.90
8582.83751	GN 1/4 - 16,2 x 26,5 x H 6,5 cm			21.15
8582.83749	GN 1/6 - 16,2 x 17,6 x H 6,5 cm			17.60
8582.84300	GN 1/1 - 32,5 x 53,0 x H 10,0 cm			56.40
8582.84301	GN 1/2 - 32,5 x 26,5 x H 10,0 cm			34.65
8582.84302	GN 2/4 - 16,2 x 53,0 x H 10,0 cm			41.15
8582.84303	GN 1/3 - 32,5 x 17,5 x H 10,0 cm			28.90
8582.84304	GN 1/4 - 16,2 x 26,5 x H 10,0 cm			25.85
8582.84305	GN 1/6 - 16,2 x 17,6 x H 10,0 cm			18.80

Schwarz | Noir

8582.83758	GN 1/1 - 32,5 x 53,0 x H 6,5 cm			50.55
8582.83756	GN 1/2 - 32,5 x 26,5 x H 6,5 cm			28.90
8582.83754	GN 2/4 - 16,2 x 53,0 x H 6,5 cm			33.50
8582.83752	GN 1/3 - 32,5 x 17,5 x H 6,5 cm			24.90
8582.83750	GN 1/4 - 16,2 x 26,5 x H 6,5 cm			21.15
8582.83748	GN 1/6 - 16,2 x 17,6 x H 6,5 cm			17.60
8582.84306	GN 1/1 - 32,5 x 53,0 x H 10,0 cm			56.40
8582.84307	GN 1/2 - 32,5 x 26,5 x H 10,0 cm			34.65
8582.84308	GN 2/4 - 16,2 x 53,0 x H 10,0 cm			41.15
8582.84309	GN 1/3 - 32,5 x 17,5 x H 10,0 cm			28.90
8582.84310	GN 1/4 - 16,2 x 26,5 x H 10,0 cm			25.85
8582.84311	GN 1/6 - 16,2 x 17,6 x H 10,0 cm			18.80

Deckel Polycarbonat Couvercle polycarbonate

8582.82001	GN 1/1			17.40
8582.82013	GN 1/2			9.85
8582.82019	GN 1/3			8.20
8582.82029	GN 1/4			6.95
8582.82037	GN 1/6			4.90



PURE

Schale rund, Melamin

Coupe ronde, mélamine

Weiss | Blanc

8582.83450	Ø 5,5 cm			3.45
8582.83419	Ø 9 cm			5.85
8582.83453	Ø 13 cm			11.70
8582.83455	Ø 15 cm			18.80
8582.83415	Ø 20 cm			32.90

Schwarz | Noir

8582.83451	Ø 5,5 cm			3.45
8582.83452	Ø 9 cm			5.85
8582.83454	Ø 13 cm			11.70



PURE

Schale rund, Melamin

Coupe ronde, mélamine

Weiss | Blanc

8582.83412	Ø 32,0 cm, H 7,5 cm			31.70
8582.83411	Ø 45,5 cm, H 9,0 cm			84.55

service & buffet

CASUAL
 Schale rund, Melamin
 Coupe ronde, mélamine

Weiss | Blanc

8582.83880	Ø 6,0 cm x H 2,5 cm			3.45
8582.83881	Ø 7,5 cm x H 3,5 cm			3.75
8582.83696	Ø 10 cm x H 4,5 cm			4.90
8582.83698	Ø 12 cm x H 5,5 cm			6.10
8582.83700	Ø 14 cm, H 6,5 cm			7.25
8582.83704	Ø 20 cm, H 9,5 cm			14.80
8582.83702	Ø 23 cm, H 10,5 cm			17.40

Schwarz | Noir

8582.83697	Ø 10 cm x H 4,5 cm			4.90
8582.83699	Ø 12 cm x H 5,5 cm			6.10
8582.83701	Ø 14 cm, H 6,5 cm			7.25
8582.83705	Ø 20 cm, H 9,5 cm			14.80
8582.83703	Ø 23 cm, H 10,5 cm			17.40

 Deckel, SAN
 Couvercle, SAN

8582.83920	Ø 20,5 cm x H 1,3 cm			14.05
------------	----------------------	--	--	-------

passend/compatible: 8582.83704 + 8582.83705

CASUAL
 Deckel, 5er Set
 Couvercle, set de 5
 Polypropylen, dichtschiessend, schwappsicherer Transport
 Polypropylène, fermeture hermétique, transport sans éclaboussures

8582.83605	Ø 8 cm			5.50/Set
<i>passend/compatible: 8582.83881, 7157.02000</i>				
8582.83606	Ø 14,5 cm			9.35/Set
<i>passend/compatible: 8582.83700, 8582.83701, 7157.06000</i>				
8582.83607	Ø 20,5 cm			10.55/Set
<i>passend/compatible: 8582.83704, 8582.83705, 7157.08000</i>				



Frischhaltedeckel
 Couvercle fraîcheur
 mit Silikondichtung, für luftdichtes Verschliessen,
 Lebensmittel bleiben lange frisch
 Avec bourrage en silicone, pour fermeture
 hermétique, nourriture reste fraîche longtemps



8582.10890	Ø 14 cm			17.60
<i>passend/compatible: 7157.06000, 8582.83701</i>				
8582.10887	Ø 23 cm			31.80
<i>passend/compatible: 7157.09000, 8582.83702, 8582.83703</i>				



CASUAL
Servierplatte/Tortenplatte, Melamin
Plateau/plat à tarte, mélamine

Weiss | Blanc



8582.83892 31 x 31 cm x H 8 cm   51.70



8582.83893 31 x 31 cm x H 16 cm   58.80







CASUAL
Dip-Schälchen rund, Melamin
Coupelle ronde, mélamine



Weiss | Blanc

8582.83780 Ø 6,0 cm, H 3,7 cm / 40 ml   1.60

8582.83781 Ø 7,0 cm, H 3,7 cm / 50 ml   2.10

8582.83782 Ø 7,8 cm, H 4,0 cm / 80 ml   3.45

8582.83783 Ø 8,5 cm, H 4,5 cm / 110 ml   3.85

8582.83784 Ø 9,8 cm, H 4,5 cm / 140 ml   4.10



MING HING
Fingerfood-Löffel, Melamin
Cuillère, mélamine

Weiss | Blanc

8582.83842 11 x 4,3 cm x H 4 cm   1.95

Schwarz | Noir

8582.83843 11 x 4,3 cm x H 4 cm   1.95



Fingerfood-Löffel, Melamin
Cuillère, mélamine

Weiss | Blanc

8582.83486 13 x 4,5 cm   2.20

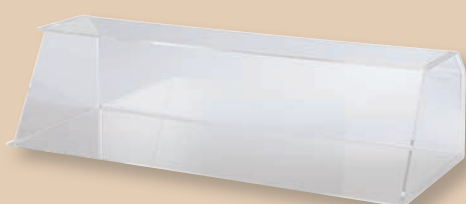

Schwarz | Noir

8582.83487 13 x 4,5 cm   2.20



Buffetvitrine
Vitrine de Buffet



Antirutsch-Füßchen, Seitenwände herausnehmbar
Pieds antidérapants, panneaux latéraux amovibles

8582.98129 56 x 20 cm, H 21 cm   96.20

service & buffet





FLEXIBEL
 Haubenthalterung
 Support de cloche

Die Haube wird am Griff in die Vorrichtung gesteckt.
 Neigungswinkel stufenlos einstellbar.
 Avec ce support, la cloche est insérée dans l'appareil par la poignée. L'angle d'inclinaison est réglable.

8582.33288 32 x 30 cm, H 38 cm   198.95







PROFI
 Buffetbrett
 Planche découper buffet

Eichenholz geölt, Safrinrinne, Antirutsch-Füßchen
 Bois chêne huilé, avec rigole, pieds antidérapants

8582.00805 Ø 33 cm, H 4,5 cm   81.15
 8582.00816 Ø 39 cm, H 4,5 cm   136.50



Frischhaltehaube
 Cloche

Polycarbonat, schwere, glasklare Qualität
 polycarbonate, qualité stable et clarté cristalline

8582.06519 Ø 21 cm, H 17 cm   35.15
passend/compatible: 8582.33292, 8582.33293
 8582.06520 Ø 30 cm, H 22 cm   45.85
passend/compatible: 8582.00805, 8582.33294, 8582.33295
 8582.06521 Ø 36 cm, H 27 cm   84.55
passend/compatible: 8582.00816, 8582.33296, 8582.33297

Frischhaltehaube
 Cloche

Polycarbonat, schwere, glasklare Qualität
 polycarbonate, qualité stable et clarté cristalline

8582.06512 Ø 30 cm, H 11,5 cm   11.70
passend/compatible: 8582.00805



PROFI
Buffetbrett
Planche découper buffet

Eichenholz geölt, Safrinne, Antirutsch-Füßchen
Bois chêne huilé, avec rigole, pieds antidérapants

8582.00806	58 x 37,5, H 4,5 cm		136.50
8582.00807	38 x 32, H 4,5 cm		91.60



Kuppelhaube
Couvercle coupole

SAN, ohne Front-Ausschnitt, Haubengriff chrom
SAN, sans ouverture latérale, poignée chromée

8005.30740	GN 1/1		76.20
<i>passend/compatible: 8582.00806</i>			
8582.11021	GN 1/2		45.85
<i>passend/compatible: 8582.00807</i>			



Rolltophaube
Couvercle

Polycarbonat, bruchfest, leichtgängig auf- und zuklappbar 90°,
temperaturbeständig
Polycarbonat, incassable, facilement pliable, résiste au
températures

Griff chrom Poignée chromée			
8005.30759	GN 1/1		93.85
<i>passend/compatible: 8582.00806</i>			
8582.12010	GN 1/2		86.90
<i>passend/compatible: 8582.00807</i>			
Griff gold Poignée doré			
8005.30752	GN 1/1		93.85
<i>passend/compatible: 8582.00806</i>			

service & buffet

**ACACIA**
Servier- und Tortenplatte
Présentoir à gateauxAkazienholz geölt
Bois d'acacia huilé

8582.33292	Ø 24 cm, H 8 cm			66.80
8582.33293	Ø 24 cm, H 16 cm			79.80
8582.33294	Ø 33 cm, H 8 cm			89.80
8582.33295	Ø 33 cm, H 16 cm			111.70
8582.33296	Ø 38,5 cm, H 8 cm			115.80
8582.33297	Ø 38,5 cm, H 16 cm			139.80

SUPER DOME
Frischhalte-Haube
ClochePolycarbonat, schwere, glasklare Qualität
Polycarbonate, haute résistance et transparence

8582.06525	Ø 30 x H 40 cm			69.35
------------	----------------	--	--	-------

passend/compatible: 8582.33294, 8582.33295, 8582.00805

**Brotschneidebrett**
Planche tranche-painmit herausnehmbarem Krümmelfach, aus massivem Naturholz, auf
4 Antirutschfüßchen stehend (ohne Messer)
Bois naturel, casier à miettes retirable, 4 pieds anti-glissants (sans
couteau)

8582.00956	GN 1/1 53 x 32,5 x H 2 cm			42.30
8005.50850	47,5 x 32 x H 2 cm			41.15
8582.00957	60 x 40 x H 2 cm			46.90

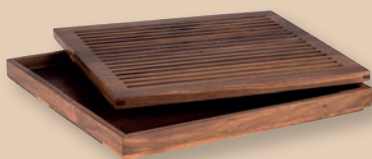
**Brotschneidebrett**
Planche tranche-painSchneidebrett aus geöltem Walnussholz mit Antirutsch-Füßchen
Planche à découper en bois de noyer huilé avec pieds
antidérapants

8582.00911	35,4 x 32,5 x H 3,5 cm			105.70
------------	------------------------	--	--	--------

FRILICH
THE ORIGINAL
EST 1965**PICKNICK****Frischeplatte****Plateau fraîcheur**

mit Porzellanplatte, Standfuss aus spülmaschinegeeignetem Polykorb, isolierter Standfusseinsatz, Kühlkissen, mit EARTH/PICKNICK Haube kombinierbar
avec plaque en porcelaine, pied en polypanier lavable au lave-vaisselle, insert de pied isolé, coussin réfrigérant, peut être combiné avec la hotte EARTH/PICKNICK

8066.00301 Ø 41 x H 7cm   351.50**Ersatzteile | Pièce de rechange**

8066.00302	Porzellanplatte / Plateau en porcelaine	131.70
8066.00303	Isoliereinsatz / Insert isolant	105.80
8066.00304	Kühlkissen / Coussin réfrigérant	25.85
8066.00306	Polykorb grau / Panier en poly gris	105.80

FRILICH
THE ORIGINAL
EST 1965**PICKNICK****Frischeplatte****Plateau fraîcheur**

mit Porzellanplatte, Standfuss aus spülmaschinegeeignetem Polykorb, isolierter Standfusseinsatz, Kühlkissen, mit EARTH/PICKNICK Haube kombinierbar
avec plaque en porcelaine, pied en polypanier lavable au lave-vaisselle, insert de pied isolé, coussin réfrigérant, peut être combiné avec la hotte EARTH/PICKNICK

8066.00300 Ø 41 x H 7cm   351.50**Ersatzteile | Pièce de rechange**

8066.00302	Porzellanplatte / Plateau en porcelaine	131.70
8066.00303	Isoliereinsatz / Insert isolant	105.80
8066.00304	Kühlkissen / Coussin réfrigérant	25.85
8066.00305	Polykorb beige / Panier en poly beige	105.80

FRILICH
THE ORIGINAL
EST 1965**EARTH/PICKNICK****Haubensystem****Système de hottes**

Halterung aus Edelstahl mit zwei Öffnungsstufen, transparente Kunststoffhaube mit Edelstahlgriff
support en inox avec deux niveaux d'ouverture, capot en plastique transparent avec poignée en inox

8066.00310 Ø 40 cm   293.85**Ersatzteile | Pièce de rechange**

8066.00311	Edelstahl-Haubenhalter / Porte-hotte en inox	258.60
8066.00312	Kunststoffhaube / Hotte en plastique Ø 40 cm	62.30

service & buffet



ACACIA
Schale
Bol
Akazienholz geölt
Bois d'acacia huile

8582.00794	Ø 21 x H 8,5 cm / 1,8 L		50.55
8582.00795	Ø 25 x H 8,5 cm / 2,5 L		56.40
8582.00796	Ø 27 x H 8,5 cm / 3,0 L		63.50



Deckel mit Löffelaussparung
Couvercle avec encoche pour la louche

8582.83920	Ø 20,5 cm x H 1,3 cm		14.05
------------	----------------------	--	-------

passend/compatible: 8582.00794



MULTI ROUND
Büffetständer
Présentoir buffet
Metall, mit schwarzer Antirutschbeschichtung
Métal, avec revêtement antidérapant noir

8582.33269	Ø 15,5 x H 8 cm		16.40
8582.33270	Ø 15,5 x H 10 cm		18.80
8582.33271	Ø 15,5 x H 18 cm		23.50



STAR
Buffet-Ständer
Présentoir buffet

Metall, mit schwarzer Antirutschgummierung,
perfekt für Platten und Schalen
metal avec revêtement plastique noir anti-glisse,
idéal pour plats et saladiers

8582.33260	H 8 cm		22.50
8582.33261	H 12 cm		28.15
8582.33262	H 18 cm		31.65





ACACIA
Servierbrett
Planche à servir
Akazienholz geölt
Bois d'acacia huile

8582.00897	30 x 15 cm x 2 cm		19.40
8582.00898	30 x 18 cm x 2 cm		23.40
8582.00899	35 x 25 cm x 2 cm		32.40









NARROW I
Servierbrett
Planche à servir
 Akazienholz, mit 3 Vertiefungen Ø 4 cm
 Bois d'acacia, avec 3 encoches Ø 4 cm

8582.00864 22 x 8 cm x H 1,5 cm   14.55





SIMPLY WOOD
Servierbrett
Planche de service
 Eichenholz geölt, mit Aufhängeloch Ø 1,5 cm, mit Lederband
 Bois de chêne huilé, avec trou de suspension Ø 1,5 cm avec ruban
 decuir

8582.00750 20 x 20 x H 2 cm   35.15
 8582.00751 27 x 17 x H 2 cm   41.15
 8582.00752 32 x 22 x H 2 cm   56.40



SIMPLY WOOD
Servierbrett , GN 1/3
Planche de service, GN 1/3

Eichenholz geölt, mit Vertiefung Ø 4 cm, mit Safrinne
 Bois de chêne huilé, avec encoche Ø 4 cm, avec rigole

8582.00754 32,5 x 17,6 x H 2 cm   31.70



Servier- und Tortenplatte
Présentoir à gâteaux

Eichenholz geölt, mit Safrille
 Bois de chêne huilé, avec rainure à jus

8582.00818 32 cm, H 2 cm   42.30

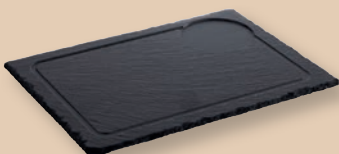

Naturschieferplatte
Plat ardoise naturelle

mit Safrinne, mit Aussparung Ø 9,5 cm
 avec rigole, avec encoche Ø 9,5 cm

8582.00947 33 x 24 cm   15.95

service & buffet



point
virgule

BAMBOO
Servierbrett
Planche à servir
aus Bambus
en bambou

880-50300	43,0 x 15,8 cm x H 1,8 cm			18.50
-----------	---------------------------	---	---	-------







point
virgule

BAMBOO
Servierbrett XXL
Planche à servir XXL
aus Bambus
en bambou

880-56600	75 x 14 cm			26.95
880-56700	90 x 14 cm			30.55





point
virgule

BAMBOO
Schneidebrett
Planche à découper
aus Bambus
en bambou

880-50000	20,0 x 14,5 cm x H 1,8 cm			6.95
880-50100	34,0 x 15,8 cm x H 1,8 cm			13.40
880-50200	34,0 x 29,0 cm x H 1,8 cm			19.85

point
virgule

BAMBOO
Fleischbrett
Planche à viande
aus Bambus
en bambou

880-50400	40,0 x 30,0 cm x H 3 cm			41.40
880-50500	51,0 x 35,5 cm x H 3 cm			62.25



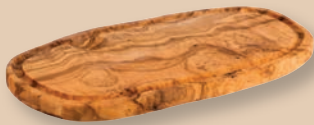

OLIVE
Servierbrett
Planche à servir
aus Olivenholz, im Naturschnitt
en bois d'olivier

8582.00870	25,0 x 17,0 cm			51.65
8582.00878	30,0 x 20,5 cm			79.80



OLIVE
Servierbrett
Planche de service
 Aus geöltem Olivenholz
 En bois d'olivier huilé

8582.01021 35,5 x 18,5 cm, H 2 cm   37.60









OLIVE
Servierbrett
Planche de service
 Aus geöltem Olivenholz
 En bois d'olivier huilé

8582.01022 39,5 x 21 cm, H 2,5 cm   46.90



OLIVE
Schale
Bol
 Aus geöltem Olivenholz
 En bois d'olivier huilé

8582.01010 Ø 10 cm, H 4 cm   14.30
 8582.01011 Ø 12,5 cm, H 4,5 cm   19.15
 8582.01012 Ø 15 cm, H 6 cm   29.35



OLIVE
Löffel, 2er Set
Cuillère, set de 2
 Aus Olivenholz, ideal für Gewürze
 En bois d'olivier, idéal pour les épices

8582.01018 14 cm   9.35/Set



OLIVE
Pelle
 Aus geöltem Olivenholz, ideal für Gewürze, Körner, etc.
 En bois d'olivier huilé, idéal pour les épices, céréales, etc.

8582.01020 13,5 cm   10.55

service & buffet



ANCIENT
Servierbrett
Planche à servir
Mangoholz
Bois de mangue

8009.69970	38 x 19 cm			22.30
8009.69971	48 x 24 cm			27.75



ANCIENT
Servierbrett
Planche à servir
Mangoholz
Bois de mangue

8009.69972	38 x 28 cm			27.75
8009.69973	48 x 37 cm			38.80



CHOP
Holzbrett auf Fuss
Planche en bois sur pied
Akazienholz
Bois d'acacia

8009.69725	28 x 17 cm x H 7,5 cm			25.40
------------	-----------------------	--	--	-------







CHOP
Holzbrett auf Fuss
Planche en bois sur pied
Akazienholz
Bois d'acacia

8009.69738	50 x 28 cm x H 7,5 cm			55.25
------------	-----------------------	--	--	-------





LES ESSENCES
Holzbrett
Planche en bois

Eiche | Chêne
59242939220 50 x 21 cm x H 2 cm   69.80

Walnuss| Noyer
59242943220 50 x 21 cm x H 2 cm   82.10





LES ESSENCES
Holzbrett
Planche en bois



Eiche | Chêne
59242940220 36,7 x 30 cm x H 2 cm   69.80

Walnuss| Noyer
59242944220 36,7 x 30 cm x H 2 cm   82.10





LES ESSENCES
Holzbrett
Planche en bois



Eiche | Chêne
59242941220 35 x 21 cm x H 2 cm   69.80

Walnuss| Noyer
59242945220 35 x 21 cm x H 2 cm   82.10



LES ESSENCES
Holzbrett
Planche en bois

Eiche | Chêne
59242942220 Ø 29,4 cm x H 2 cm   69.80

Walnuss| Noyer
59242946220 Ø 29,4 cm x H 2 cm   82.10

service & buffet

**FRAMES
COOL PLATE SET**

Inox, GN 1/1
inox, GN 1/1

Basiselement GN 1/1, Edelstahltablett GN 1/1, Kühlakku

Elément base GN 1/1, plateaux inox GN 1/1, accu de refroidissement

400-12940 GN 1/1 - 53 x 32,5 x 8,5 cm   425.00

**FRAMES
COOL PLATE SET**

Inox, GN 1/1 Rolltop
inox, GN 1/1 rolltop

Basiselement GN 1/1, Edelstahltablett GN 1/1, Rolltop-Haube, Kühlakku

Elément base GN 1/1, plateaux inox GN 1/1, couvercle roll-top, accu de refroidissement

400-12941 GN 1/1 - 53 x 32,5 x 25,5 cm   525.00

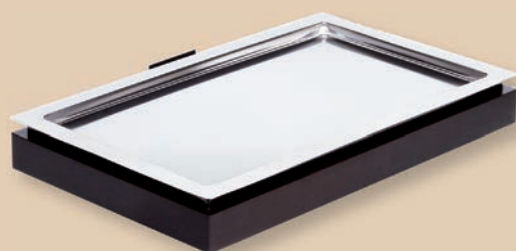
**FRAMES
COOL PLATE SET**

Wenge, GN 1/1
Wéngé, GN 1/1

Basiselement GN 1/1, Edelstahltablett GN 1/1, Kühlakku

Elément base GN 1/1, plateaux inox GN 1/1, accu de refroidissement

400-14940 GN 1/1 - 53 x 32,5 x 8,5 cm   425.00

**FRAMES
COOL PLATE SET**

Wenge, GN 1/1 Rolltop
Wéngé, GN 1/1 rolltop

Basiselement GN 1/1, Edelstahltablett GN 1/1, Rolltop-Haube, Kühlakku

Elément base GN 1/1, plateaux inox GN 1/1, couvercle roll-top, accu de refroidissement

400-14941 GN 1/1 - 53 x 32,5 x 25,5 cm   525.00

**FRAMES
COOL PLATE SET**

Ahorn, GN 1/1
Érable, GN 1/1

Basiselement GN 1/1, Edelstahltablett GN 1/1, Kühlakku

Elément base GN 1/1, plateaux inox GN 1/1, accu de refroidissement

400-13940 GN 1/1 - 53 x 32,5 x 8,5 cm   425.00

**FRAMES
COOL PLATE SET**

Ahorn, GN 1/1 Rolltop
Érable, GN 1/1 rolltop





Basiselement GN 1/1, Edelstahltablett GN 1/1, Rolltop-Haube, Kühlakku

Elément base GN 1/1, plateaux inox GN 1/1, couvercle roll-top, accu de refroidissement

400-13941 GN 1/1 - 53 x 32,5 x 25,5 cm   525.00







**FRAMES
TRAYS**

GN-Edelstahtablett
GN-plateau inox







8582.11119 GN 1/1 - 53 x 32,5 cm   50.55
400-11118 GN 1/2 - 32,5 x 26,5 cm   31.60

**FRAMES
TRAYS**

GN-Tablett, Melamin
GN-plateau, mélamine

400-84046 GN 1/1 - 53,0 x 32,5 cm   51.65
400-84047 GN 1/2 - 32,5 x 26,5 cm   28.15
400-84048 GN 1/3 - 32,5 x 17,5 cm   19.65



GN-Tablett, Porzellan
GN-plateau, porcelaine

8582.82355 GN 1/1 - 53,0 x 32,5 cm   64.65
8582.82356 GN 1/2 - 32,5 x 26,5 cm   37.60
8582.82357 GN 1/3 - 32,5 x 17,6 cm   30.20

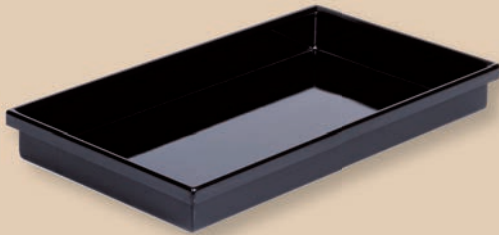
service & buffet



FRAMES
Polystrolwanne, schwarz
Bac polystyrène, noir

400-17922 GN 1/1 - 53 x 32,5 x 8,5 cm   91.40



FRAMES
Kühlakku
Accus de refroidissement

400-10782   25.85



FRAMES
Eisbox
Caisse à glaçons

3-teilig: 1 x Basiselement Wenge, 1 x Polystyrolwanne,
1 x Tropfgitter
3 pcs: 1 x élément de base wéngé, 1 x bac polystyrène,
1 x plaque perforée

400-14970 GN 1/1 - 53 x 32,5 x 12,5 cm   289.00

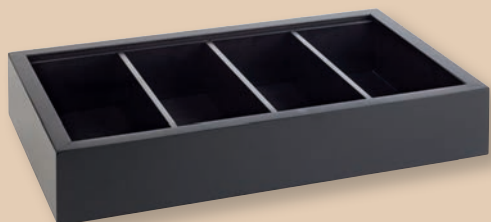



FRAMES
Besteckbox/Universalbox
Caisse à couverts ou multi-usages

Wenge, GN 1/1
Wéngé, GN 1/1

4 Fächer, inklusive herausnehmbarem Einsatz
4 compartiments, séparateur amovible inclus

400-14956 GN 1/1 - 53 x 32,5 x 12,5 cm   279.00

Ersatz-Einsatz | Séparateur de rechange

400-14954 48,5 x 28 cm   69.80

**FRAMES
CHOPPING BOARD**Ahorn, massiv
Érable, massif

400-13955 GN 1/1 - 53 x 32,5 cm

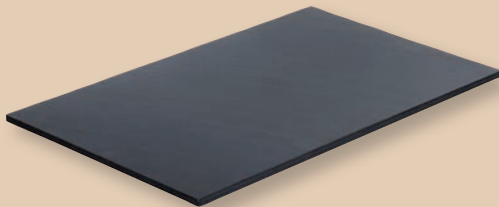

91.40

**FRAMES
CHOPPING BOARD**Polyethylen, schwarz
Polyéthylène, noir

400-17910 GN 1/1 - 53 x 32,5 cm



98.70

**FRAMES
CHOPPING BOARD**Naturschieferplatte
Plat ardoise

8582.00990 GN 1/1 - 53 x 32,5 cm



27.75

8582.00991 GN 1/2 - 32,5 x 26,5 cm

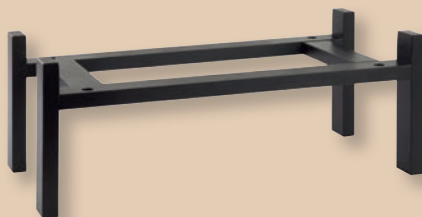

14.30

**FRAMES
Gestell für GN 1/1 für das Frames Buffet
Support pour GN 1/1 pour le buffet Frames**Vielseitig einsetzbar, für alle GN 1/1 Artikel
Usage multiple, pour tous les articles GN 1/1

Wenge | Wengé

400-14953 57,7 x 27,5 cm x H 22 cm





114.60

service & buffet

**FRAMES
BASKET GN 1/1**

Polyrattan Korb, dunkelbraun, mit Haubenschiene
(ohne Haube 400-11018)

Corbeille rotin, brun foncé, avec coiffe
(sans couvercle rolltop 400-11018)

400-40294 GN 1/1 53 x 32,5 x 6,5 cm   54.00

**FRAMES
COVER**



GN 1/1 Rolltop-Haube
GN 1/1 couvercle rolltop

400-11018 GN 1/1 - 53 x 32,5 cm   98.70

**FRAMES
BASKET**

Polyrattan Korb, dunkelbraun, mit Haubenschiene
(ohne Haube 400-18389)

Corbeille rotin, brun foncé, avec coiffe
(sans couvercle rolltop 400-18389)

400-40295 Ø 35 cm, H 20 cm   37.50

**FRAMES
COVER**

Rolltop-Haube für Basket Round (400-40295)
Couvercle rolltop pour Basket round (400-40295)





400-18389   46.50



**FRAMES
BASKET GN 1/1**

Polyrattan Korb, dunkelbraun

Corbeille en poly-rotin, brun





8582.40291	GN 1/1 53 x 32,5 x 6,5 cm			35.15
8582.40293	GN 1/1 53 x 32,5 x 10 cm			43.50



**FRAMES
BASKET GN 1/2**

Polyrattan Korb, dunkelbraun



Corbeille en poly-rotin, brun

8582.40290	GN 1/2 32,5 x 26,5 x 6,5 cm			22.30
8582.40292	GN 1/2 32,5 x 26,5 x 10 cm			26.10







**Buffet-Korb GN 1/1
Corbeille de buffet GN 1/1**

Poly-Rattankorb, stabile Ausführung, mit Fixierahmen, ohne Haube
Poly-rotin, exécution solide, avec cadre de fixation, sans couvercle

8005.60815	GN 1/1 53 x 32,5 x 8 cm			56.40
------------	-------------------------	---	---	-------



**Haube GN 1/1
Couvercle GN 1/1**

8005.30752	Griff gold/poignée doré			93.85
8005.30759	Griff chrom/poignée chromée			93.85



**Eier-Korb
Corbeille à oeufs**

stabile Vollweide, hält den Inhalt durch das sehr dicht verarbeitete Stoff-Futter lange warm
bois de saule stable, intérieur tissu à grande densité pour garder les oeufs chauds pendant long temps

8005.30735	Ø 26 cm x H 17 cm			28.90
------------	-------------------	---	---	-------

service & buffet

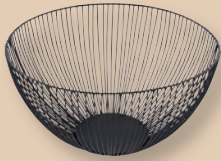

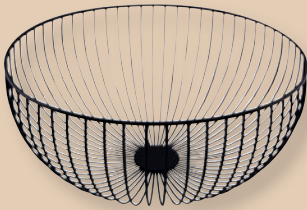

point
virgule

WIRE
Drahtkorb schwarz
Corbeille à pain et fruits

880-56300	Ø 25 cm x H 14 cm			21.15
-----------	-------------------	---	---	-------





point
virgule

WIRE
Drahtkorb schwarz
Corbeille à pain et fruits

880-56400	Ø 30 cm x H 13 cm			26.95
880-56500	Ø 35 cm x H 15 cm			34.65







SVART
Korb rund
Corbeille ronde

8582.30420	Ø 17,5 x H 8 cm			19.95
8582.30421	Ø 20,0 x H 8 cm			22.30



SVART
Drahtkorb schwarz
Corbeille à pain et fruits

8582.30422	20 x 15 x H 8 cm			19.95
8582.30423	24 x 19 x H 8 cm			27.75

**Brot- und Obstkorb rund****Corbeille à pain et fruits**

stapelbar, spülmaschinenfest, ideal für Obst und Brötchen
empilable, garantie au lave-vaisselle, idéal pour fruits et petit-pains

Inox

8005.00409	Ø 20 cm	rund/rond			25.85
8005.00410	Ø 25,5 cm	rund/rond			26.95

**Brot- und Obstkorb oval****Corbeille à pain et fruits ovale**

stapelbar, spülmaschinenfest, ideal für Obst und Brötchen
empilable, garantie au lave-vaisselle, idéal pour fruits et petit-pains

Inox

8005.00411	24,5 x 18 cm	oval/ovale			25.85
8005.00412	28,0 x 21 cm	oval/ovale			26.95

**Obstkorb****Corbeille à fruits**

stapelbar, spülmaschinenfest, ideal für Obst
empilable, garantie au lave-vaisselle, idéal pour fruits

Inox

8005.00400	Ø 21,5 cm x H 20,5 cm				55.25
------------	-----------------------	--	--	--	-------

**URBAN****Serviettenhalter****Porte-serviettes**

Metall, für ca. 50 Servietten, inkl. Beschwerer
Métal, pour environ 50 serviettes, incl. barre de contreponds

8582.11770	19 x 19 x H 7,5 cm			16.40
------------	--------------------	--	--	-------

**URBAN****Serviettenhalter****Porte-serviettes**



Metall, für ca. 120 Servietten, inkl. Beschwerer
Métal, pour environ 120 serviettes, incl. barre de contreponds

8582.11771	19 x 19 x H 18 cm			21.15
------------	-------------------	--	--	-------

service & buffet

LITTLE GN 1/3
Buffetleiter
Echelle de buffet



4-teilig: 1 x Leiter-Gestell, 3 x Rahmen GN 1/3
 4 pcs: 1 x echelle, 3 x cadres GN 1/3

8582.11526 31,5 x 32 x H 48 cm   110.75

Ersatzleiter | Echelle de rechange

8582.11495   57.60

Ersatzrahmen | Cadre de rechange

8582.11524 GN 1/3   23.35

Passend für GN 1/3 oder 2 x GN 1/6
 pour GN 1/3 ou 2 x GN 1/6

LITTLE GN 1/2
Buffetleiter
Echelle de buffet

4-teilig: 1 x Leiter-Gestell, 3 x Rahmen GN 1/2
 4 pcs: 1 x echelle, 3 x cadres GN 1/2

8582.11527 31,5 x 41,5 x H 48 cm   139.80

Ersatzleiter | Echelle de rechange

8582.11495   57.60



Ersatzrahmen | Cadre de rechange

8582.11523 GN 1/2   30.50

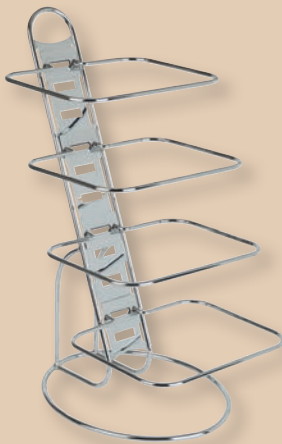
Passend für GN 1/2
 pour GN 1/2

BIG GN 1/2
Buffetleiter
Echelle de buffet

5-teilig: 1 x Leiter-Gestell, 4 x Rahmen GN 1/2
 5 pcs: 1 x echelle, 4 x cadres GN 1/2

8582.11528 31,5 x 56 x H 66 cm   234.50

Ersatzleiter | Echelle de rechange

8582.11595   143.50



Ersatzrahmen | Cadre de rechange

8582.11523 GN 1/2   30.50



Passend für GN 1/2
 pour GN 1/2

BIG GN 1/1
Buffetleiter
Echelle de buffet



4-teilig: 1 x Leiter-Gestell, 3 x Rahmen GN 1/1
 4 pcs: 1 x echelle, 3 x cadres GN 1/1

8582.11529 31,5 x 56 x H 66 cm   234.50

Ersatzleiter | Echelle de rechange

8582.11595   143.50

Ersatzrahmen | Cadre de rechange

8582.11522 GN 1/1   43.40

Passend für GN 1/1, 2 x GN 1/2 oder 3 x GN 1/3
 pour GN 1/1, 2 x GN 1/2 ou 3 x GN 1/3



Büffet-Korb GN, Polypropylen
Corbeille de buffet GN, polypropylène
 stabile Ausführung mit Edelstahldraht im Rand zur Stabilisierung
 très résistante avec son fil de renfort inox

8582.40220	GN 1/1 - 53,0 x 32,5 x H 6,5 cm			32.90
8582.40222	GN 1/2 - 32,5 x 26,5 x H 6,5 cm			21.15
8582.40224	GN 1/3 - 32,5 x 17,5 x H 6,5 cm			17.15
8582.40226	GN 1/4 - 26,4 x 16,2 x H 6,5 cm			11.70
8582.40228	GN 1/6 - 17,6 x 16,2 x H 6,5 cm			8.90
8582.40230	GN 2/3 - 32,5 x 35,4 x H 6,5 cm			26.10
8582.40240	GN 1/1 - 53,0 x 32,5 x H 10 cm			42.30
8582.40242	GN 1/2 - 32,5 x 26,5 x H 10 cm			26.10
8582.40244	GN 1/3 - 32,5 x 17,5 x H 10 cm			19.75
8582.40246	GN 1/4 - 26,4 x 16,2 x H 10 cm			14.30
8582.40248	GN 1/6 - 17,6 x 16,2 x H 10 cm			11.70
8582.40250	GN 2/3 - 32,5 x 35,4 x H 10 cm			31.70



Büffet-Korb GN, Polypropylen
Corbeille de buffet GN, polypropylène
 stabile Ausführung mit Edelstahldraht im Rand zur Stabilisierung
 très résistante avec son fil de renfort inox

8582.40291	GN 1/1 - 53,0 x 32,5 x H 6,5 cm			35.15
8582.40290	GN 1/2 - 32,5 x 26,5 x H 6,5 cm			22.30
8582.40223	GN 1/3 - 32,5 x 17,5 x H 6,5 cm			17.95
8582.40225	GN 1/4 - 26,5 x 16,2 x H 6,5 cm			13.95
8582.40227	GN 1/6 - 17,6 x 16,2 x H 6,5 cm			9.85
8582.40229	GN 2/3 - 32,5 x 35,4 x H 6,5 cm			26.10
8582.40293	GN 1/1 - 53,0 x 32,5 x H 10 cm			43.50
8582.40292	GN 1/2 - 32,5 x 26,5 x H 10 cm			26.10
8582.40243	GN 1/3 - 32,5 x 17,5 x H 10 cm			21.85
8582.40245	GN 1/4 - 26,5 x 16,2 x H 10 cm			16.80
8582.40247	GN 1/6 - 17,6 x 16,2 x H 10 cm			13.95
8582.40249	GN 2/3 - 32,5 x 35,4 x H 10 cm			31.70



MINI
Schälchenspender
Dispenser de coupelles
 Inox, ohne Schalen, geeignet für max. 36 Glas- und Melamin-
 schalen Ø 6 cm
 Inox, sans coupelles, pour max. 36 coupelles en verre ou en
 mélamine de Ø 6 cm

Inox				
8582.11980	Ø 14 cm x H 25,5 cm			76.20
Schale Melamin weiss Coupelle mélamine blanc				
8582.83880	Ø 6,0 cm x H 2,5 cm			3.45
Schale Glas Coupelle verre				
7157.01000	Ø 6 cm			0.95



Topf, doppelwandig
Récipient à parois double
 ideal für Salatdressing, heisse und kalte Saucen
 idéal pour sauce à salade ainsi que pour sauces froides et chaudes

Inox				
8582.30043	1,8 L / Ø 15 cm x H 18 cm			66.80

service & buffet

LITTLE
 Buffetleiter
 Echelle de buffet

 Metall
 Métal

 8582.11495 ca. 30 x 30 cm x H 48 cm   57.60

LITTLE
 Schalenring
 Reposoir pour bol

 Metall, zu Buffetleiter «Little», für Schalen Ø 14 cm
 Métal, pour échelle de buffet «Little», pour bols Ø 14 cm

Einzelring | Reposoir single

 8582.11496   16.40

Doppelring | Reposoir double

 8582.11497   27.75

BIG
 Buffetleiter
 Echelle de buffet

 Metall
 Métal

 8582.11595 ca. 39 x 31 cm x H 66 cm   143.50

BIG
 Schalenring
 Reposoir pour bol

 Metall, zu Buffetleiter «Big», für Schalen Ø 23,5 cm
 Métal, pour échelle de buffet «Big», pour bols Ø 23,5 cm

Einzelring | Reposoir single





 8582.11596   22.30

Doppelring | Reposoir double

 8582.11597   41.15





**BOWLS**

Melaminschüssel weiss
Coupe mélamine, blanc

8582.83700	Ø 14 cm, H 6,5 cm			7.25
8582.83702	Ø 23 cm, H 10,5 cm			17.40





**BOWLS**

Melaminschüssel schwarz
Coupe mélamine, noir

8582.83701	Ø 14 cm, H 6,5 cm			7.25
8582.83703	Ø 23 cm, H 10,5 cm			17.40



**BOWLS**

Glasschüssel
Coupe verre

7157.06000	Ø 14 cm, H 6,5 cm			2.65
7157.09000	Ø 23 cm, H 10 cm			5.85

**BOWLS COVER**



Deckel mit Dichtungsring für luftdichtes Verschiessen
Couvercle avec anneau de joint pour fermeture hermétique



8582.10890	Ø 14,5 cm			17.60
8582.10887	Ø 23 cm			31.80



service & buffet

**Serviergestell****Support pour service**

Metall hartverchromt, Metallprofil flach, Lieferung ohne Teller
 Metall dur chromage, profil métal plat, livré sans assiettes



für 3 Teller bis max. Ø 17 cm, innerer Ring Ø 10,5 cm
 pour 3 assiettes de max. Ø 17 cm, rond intérieur Ø 10,5 cm
 8582.33216 22,5 x 16,5 cm x H 25,5 cm   45.85



für 3 Teller bis max. Ø 27 cm, innerer Ring Ø 18 cm
 pour 3 assiettes de max. Ø 27 cm, rond intérieur Ø 18 cm
 8582.33217 33 x 24 cm x H 43 cm   74.95



für 2 Teller bis max. Ø 27 cm, innerer Ring Ø 18 cm
 pour 2 assiettes de max. Ø 27 cm, rond intérieur Ø 18 cm
 8582.33214 33 x 23,5 cm x H 30 cm   51.65

**Serviergestell****Présentoir à assiettes**

Metall hartverchromt, Metallprofil rund, Lieferung ohne Teller
 Metall dur chromage, en tube métallique, livré sans assiettes



für 3 Teller bis max. Ø 17 cm, innerer Ring Ø 10,5 cm
 pour 3 assiettes de max. Ø 17 cm, rond intérieur Ø 10,5 cm
 8005.35670 18,5 x 15,5 cm x H 26 cm   34.05



für 3 Teller bis max. Ø 27 cm, innerer Ring Ø 18 cm
 pour 3 assiettes de max. Ø 27 cm, rond intérieur Ø 18 cm
 8005.35671 29,0 x 19,5 cm x H 43 cm   61.15

für 2 Teller bis max. Ø 27 cm, innerer Ring Ø 18 cm
 pour 2 assiettes de max. Ø 27 cm, rond intérieur Ø 18 cm
 8582.33219 29,0 x 19,5 cm x H 30 cm   49.35

**Serviergestell****Présentoir à assiettes**

Metall kupfer-look, Metallprofil rund, Lieferung ohne Teller
 Metal cuivre, en tube métallique, livré sans assiettes

für 3 Teller bis max. Ø 17 cm, innerer Ring Ø 10,5 cm
 pour 3 assiettes de max. Ø 17 cm, rond intérieur Ø 10,5 cm
 8582.33211 18,5 x 15,5 cm x H 26 cm   38.70

für 3 Teller bis max. Ø 27 cm, innerer Ring Ø 18 cm
 pour 3 assiettes de max. Ø 27 cm, rond intérieur Ø 18 cm
 8582.33212 29,0 x 19,5 cm x H 43 cm   63.50

**MOON****Servierset, 6-teilig****Set de service, 6 pièces**

Melamin, 6-teiliges Set: 3 Schalen + 3 Löffel

Mélamine, set de 6: 3 bols + 3 cuillères

8582.85080 Ø 8 cm x H 7,5 cm



49.35

**MOON****Servierset, 6-teilig****Set de service, 6 pièces**

Melamin, 6-teiliges Set: 3 Schalen + 3 Löffel

Mélamine, set de 6: 3 bols + 3 cuillères

8582.85081 Ø 8 cm x H 7,5 cm



49.35

**MOON****Servierset, 2-teilig****Set de service, 2 pièces**

Melamin, 2-teiliges Set: 1 Schale + 1 klappbarer Deckel

Mélamine, set de 2: 1 bol + 1 couvercle avec charnières

8582.85082 Ø 19 cm x H 17,5 cm



58.80

Ersatz-Deckel | Couvercle de remplacement

8582.85084



9.35

**MOON****Servierset, 2-teilig****Set de service, 2 pièces**

Melamin, 2-teiliges Set: 1 Schale + 1 klappbarer Deckel

Mélamine, set de 2: 1 bol + 1 couvercle avec charnières

8582.85083 Ø 19 cm x H 17,5 cm



58.80

Ersatz-Deckel | Couvercle de remplacement

8582.85084



9.35

**Cerealien-Karaffe****Carafe pour céréales**

für Müsli, Cornflakes etc., schwenkbarer Edelstahldeckel aus bruchfestem Polycarbonat, spülmaschinenfest, inkl. 1 luftdichtem Frischhaltedeckel

Pour müsli, cornflakes etc, couvercle en acier inoxydable pivotant en polycarbonate incassable, convient au lave-vaisselle, incl. 1 couvercle de conservation étanche

8582.10778 1,5 L / Ø 10 x H 28 cm



39.95

Ersatz-Deckel | Couvercle de remplacement

8582.10668



4.65

service & buffet

**Cerealien-Bar, 5-tlg.**
Bar pour céréales, 5 pièces

1 Ständer aus Plexiglas, gefrostet und rutschfest, 2 Karaffen aus Polycarbonat mit schwenkbaren Edelstahldeckel und 2 luftdichte Frischhaltedeckel, 2 Ständerhöhen: 4 oder 8 cm
 1 support en plexiglas, mat et antidérapant, 2 carafes en polycarbonate avec couvercle en acier inoxydable pivotant et 2 couvercles de conservation étanches, 2 tailles de support: 4 ou 8 cm

8582.11971	26 x 15,5 x H 4 cm			112.30
8582.11972	26 x 15,5 x H 8 cm			161.15

Ersatz-Karaffe | Carafe de remplacement

8582.10778	1,5 L / Ø 10 x H 28 cm			39.95
8582.10668	Ersatzdeckel/Couv. de rech.			4.65

**Cerealien-Bar, 7-tlg.**
Bar pour céréales, 7 pièces

1 Ständer aus Plexiglas, gefrostet und rutschfest, 3 Karaffen aus Polycarbonat mit schwenkbaren Edelstahldeckel und 3 luftdichte Frischhaltedeckel, 2 Ständerhöhen: 4 oder 8 cm
 1 support en plexiglas, mat et antidérapant, 3 carafes en polycarbonate avec couvercle en acier inoxydable pivotant et 3 couvercles de conservation étanches, 2 tailles de support: 4 ou 8 cm

8582.11973	38 x 15,5 x H 4 cm			161.15
8582.11974	38 x 15,5 x H 8 cm			174.50

Ersatz-Karaffe | Carafe de remplacement

8582.10778	1,5 L / Ø 10 x H 28 cm			39.95
8582.10668	Ersatzdeckel/Couv. de rech.			4.65

AdHoc®**DEPOSITO****Cerealien-Spender mit Ständer****Distributeur de céréales avec support**

Edelstahl/Acryl, Ständer abnehmbar, Volumen ca. 1,5 L
 Inox/acrylique, support amovible, capacité env. 1,5 l

161156100	Ø 15 cm x H 42,5 cm			89.80
-----------	---------------------	--	--	-------



AdHoc®**DEPOSITO DUO****Set Cerealien-Spender mit Doppelständer****Set de distributeurs de céréales avec support double**

Edelstahl/Acryl, Ständer abnehmbar, Volumen je ca. 1,5 L
 Inox/acrylique, support amovible, capacité env. 1,5 l



161156105	Ø 15 cm x H 42,5 cm			164.00
-----------	---------------------	--	--	--------

**Getränkespender****Distributeur de boissons**

Dicke, stabile Wände, weite Öffnung für grosse Zutaten, hochwertiger Hahn aus Edelstahl
des murs épais et stables, large ouverture pour de grands ingrédients, robinet de haute qualité en inox

8582.10855 7 L, Ø 20 x H 30,5 cm   99.75

Ersatzteile | Pièces de rechange

8582.10857 Edelstahl-Hahn / Robinet en inox   36.95



**Beton-Fuss zu Getränkenspender****Socle béton pour distributeur de boissons**

mit Anti-Rutsch-Füsschen
avec pieds antidérapants

8582.10401 Ø 22 x H 17 cm   62.30

**Holz-Fuss zu Getränkenspender****Socle bois pour distributeur de boissons**

mit Anti-Rutsch-Füsschen
avec pieds antidérapants

8582.10404 Ø 24,5 x H 15 cm   37.60

**Eiswasserröhre****Tube pour glaçons**



mit Anti-Rutsch-Füsschen
avec pieds antidérapants

8582.10849 Ø 11 x H 24 cm   13.35



**Holz-Fuss zu Getränkenspender****Socle bois pour distributeur de boissons**

mit Anti-Rutsch-Füsschen
avec pieds antidérapants

Weiss | Blanc

8582.10851 Ø 9,5 x H 1,5 cm   11.25

Schwarz | Noir

8582.10853 Ø 9,5 x H 1,5 cm   11.25

service & buffet

FRILICH
THE ORIGINAL
EST 1965

PURE NATURE «Barrel»



Getränkespender

Distributeur de boissons

Kunststoffbehälter inkl. Universaladapter und Edelstahl-Hahn
Récipient en plastique, y compris adaptateur universel et robinet en inox

8066.00001	5 L	 	305.60
8066.00002	8 L	 	317.40

Tropfschalen-Set
Set de goutteurs

8066.00112	Ø 12 cm / H 2 cm	 	46.85
------------	------------------	---	-------

FRILICH
THE ORIGINAL
EST 1965

PURE NATURE «Wooden Platform Set»

Rutschfeste Standfusscheiben aus Rindenbretter

Pieds antidérapants en écorce

zur individuellen Gestaltung des Unterbaus für Getränkebehälter,
inkl. einer Standfusscheibe mit Saugnapfmatte zur kippssicheren
Platzierung des Getränkhalters
pour personnaliser le support des récipients à boissons, y compris
un disque de support avec tapis à ventouses pour placer le
porte-boissons sans risque de basculement

8066.00004	Ø 24 cm / Ø 10 cm	 	340.90
------------	-------------------	---	--------

Ersatzteile | Pièces de rechange

8066.00005	Saugnapf-Holzcheibe / Rondelle avec tapis à ventouses Ø 24cm	58.65
8066.00006	Holzcheibe/Rondelle de bois Ø 24cm	28.00
8066.00007	Holzcheibe/Rondelle de bois Ø 10cm	7.00

FRILICH
THE ORIGINAL
EST 1965



CONNECT «Karaffe»

Getränke-Set mit Karaffe



Set de boissons avec caraffe

inkl. Edelstahldeckel und Standfuss
incl. couvercle en inox et pied



mit Glas-Karaffe | Avec carafe en verre

8066.00010	1,2 L / 17 x 15,4 x H 30 cm	 	175.80
------------	-----------------------------	---	--------

mit Kunststoff-Karaffe | Avec carafe en plastique

8066.00011	1,2 L / 17 x 15,4 x H 30 cm	 	175.80
------------	-----------------------------	---	--------

mit Porzellan-Karaffe | Avec carafe en porcelaine

8066.00012	1,2 L / 17 x 15,4 x H 30 cm	 	198.85
------------	-----------------------------	---	--------

Ersatzteile | Pièces de rechange

8066.00111	Connect Standfuss / Connect Pied de support	131.70
------------	---	--------



FRILICH
THE ORIGINAL
EST 1965

CONNECT «Müsliflüte»

Müslispender

Distributeur de céréales

Müsliflüte 1,5 Liter aus SAN, mit Edelstahldeckel
Récipient en acrylique, couvercle en acier inox

8066.00014	1,5 L / 15,4 x 17 x H 29 cm	 	195.80
------------	-----------------------------	---	--------

Nachschubbehälter mit Deckel | Bac de réassort avec couvercle

8066.00015	1,5 L	69.85
------------	-------	-------

Ersatzteile | Pièces de rechange

8066.00016	Edelstahldeckel / Couvercle en inox	34.80
8066.00017	Behälter / Récipient 1,5 L	34.80
8066.00111	Connect Standfuss / Connect Pied de support	131.70

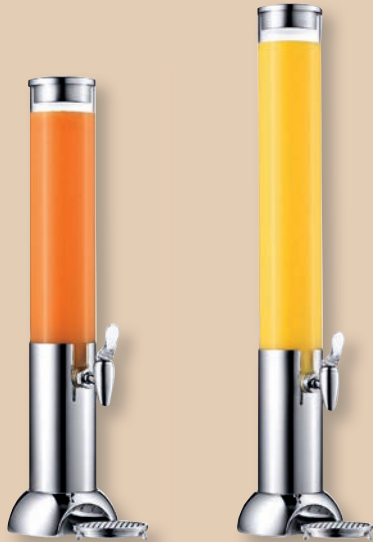
FRILICH
THE ORIGINAL
EST 1962**CONNECT «Juicer»****Saftkanne****Pot à jus**

Saftkanne aus Edelstahl, Acrylbehälter mit Edelstahl-Hahn, Kühlakku im Standfuss und in der Deckelschale, inkl. Standfuss und Tropfschale

Pot à jus en inox, récipient en acrylique avec robinet en inox, accumulateur de froid dans le pied et dans le bac du couvercle, y compris pied et bac d'égouttage

8066.00100	3 L / 17 x 19 x H 68,5 cm		586.80
8066.00101	4 L / 17 x 19 x H 82,5 cm		611.50

Nachschubbehälter | Bac de réassort

8066.00102	3 L Standfuss, Hahn, Deckel 3 L Pied, robinet, couvercle		517.40
8066.00103	4 L Standfuss, Hahn, Deckel 4 L Pied, robinet, couvercle		540.95

Ersatzteile | Pièces de rechange

8066.00104	Edelstahldeckel / Couvercle en inox	19.95
8066.00105	Kühlakku / Accu de refroidissement	4.50
8066.00106	Deckelschale / Coque de couvercle	18.80
8066.00107	3 L Behälter / 3 L Rangement	152.70
8066.00108	4 L Behälter / 4 L Rangement	164.45
8066.00109	Edelstahl-Hahn / Robinet en inox	198.85
8066.00110	Edelstahlstandfussröhre / Tube de pied en inox	131.70
8066.00111	Connect Standfuss / Connect Pied de support	131.70
8066.00112	Tropfschalen-Set / Kit de goutteurs	46.85

FRILICH
THE ORIGINAL
EST 1962**CONNECT «Hopper»****Müsli-Drehspender****Distributeur rotatif de céréales**

Acrylbehälter, Edelstahldeckel, Edelstahldrehachse, Edelstahl Standfuss

Récipient en acrylique, couvercle en inox, axe de rotation en inox, pied en inox

8066.00120	2,5 L / 19 x 17 x H 72,5 cm		517.40
8066.00121	3,5 L / 19 x 17 x H 82,5 cm		529.15
8066.00122	4,5 L / 19 x 17 x H 96,5 cm		540.95

Hopper-Modul ohne Standfuss | Module Hopper sans pied

8066.00123	2,5 L / 19 x 17 cm		423.30
8066.00124	3,5 L / 19 x 17 cm		435.05
8066.00125	4,5 L / 19 x 17 cm		458.55

Ersatzteile | Pièces de rechange

8066.00104	Edelstahldeckel / Couvercle en inox	19.95
8066.00126	2,5 L Ersatzröhre / 2,5 L Tube de remplacement	139.80
8066.00127	3,5 L Ersatzröhre / 3,5 L Tube de remplacement	152.70
8066.00128	4,5 L Ersatzröhre / 4,5 L Tube de remplacement	164.45
8066.00129	Paddel aus Silikon / Pagaie en silicone	38.70
8066.00130	Drehachse aus Edelstahl / Axe de rotation en inox	139.80
8066.00131	Edelstahlschütte / Goulotte en inox	88.20
8066.00132	Standrohr aus Edelstahl / Tube en inox	152.70
8066.00111	Connect Standfuss / Connect Pied de support	131.70

service & buffet



FRILICH
THE ORIGINAL
EST 1965

Glas-Karaffe
Carafe en verre
mit Edelstahldeckel
incl. couvercle en inox

8066.00204 1,2 L / 10 x 10 x H 28,5 cm   49.80



FRILICH
THE ORIGINAL
EST 1965

Kunststoff-Karaffe
Carafe en plastique
mit Edelstahldeckel
incl. couvercle en inox

8066.00205 1,2 L / 10 x 10 x H 28 cm   49.80

FRILICH
THE ORIGINAL
EST 1965

Porzellan-Karaffe
Carafe en porcelaine
mit Edelstahldeckel
incl. couvercle en inox

8066.00272 1,2 L / 10 x 10 x H 30 cm   74.05

FRILICH
THE ORIGINAL
EST 1965

Milch-Glasflasche
Bouteille de lait en verre
mit Silikonstopfen
avec bouchon en silicone

8066.00221 1,2 L / 10 x 10 x H 30 cm   26.95

FRILICH
THE ORIGINAL
EST 1965









CONNECT
Cerealien-Karaffe
Carafe pour céréales
Müsliflöte aus SAN, mit Edelstahldeckel
Réceptient en acrylique, couvercle en inox

8066.00015 1,5 L   69.85

Ersatzteile | Pièces de rechange









8066.00016 Edelstahldeckel / Couvercle en inox 34.80

8066.00017 Behälter / Réceptient 1,5 L 34.80

FRILICH
THE ORIGINAL
EST. 1965**CARAFINE «Triplet»****Edelstahlkrug mit 3 Karaffen****Cruche en inox avec 3 carafes**doppelwandig mit Isolierung, Crasheisröhre zum Einstellen
double paroi avec isolation, tube de glace pilée à ajusterpoliert mit Glas-Karaffen | poli avec carafes en verre
8066.00200 Ø 35 cm / H 33 cm   529.15poliert mit Kunststoff-Karaffen | poli avec carafes en plastique
8066.00201 Ø 35 cm / H 33 cm   529.15gehämmert mit Glas-Karaffen | martelée avec carafes en verre
8066.00202 Ø 35 cm / H 33 cm   564.45gehämmert mit Kunststoff-Karaffen | martelée avec en plastique
8066.00203 Ø 35 cm / H 33 cm   564.45**Ersatzteile | Pièces de rechange**

8066.00204 Karaffe Glas / Carafe verre 49.80

8066.00205 Karaffe Kunststoff / Carafe plastique 49.80

8066.00206 Kugel mit Crasheisröhre poliert
Boule avec tube de glace crashé poli 411.508066.00207 Kugel mit Crasheisröhre gehämmert
Boule avec tube de glace crashé martelée 435.05FRILICH
THE ORIGINAL
EST. 1965**CARAFINE «Quintet»****Edelstahlkrug mit 5 Karaffen****Cruche en inox avec 5 carafes**doppelwandig mit Isolierung, Crasheisröhre zum Einstellen
double paroi avec isolation, tube de glace pilée à ajusterpoliert mit Glas-Karaffen | poli avec carafes en verre
8066.00210 Ø 35 cm / H 33 cm   635.05poliert mit Kunststoff-Karaffen | poli avec carafes en plastique
8066.00211 Ø 35 cm / H 33 cm   635.05gehämmert mit Glas-Karaffen | martelé avec carafes en verre
8066.00212 Ø 35 cm / H 33 cm   670.35gehämmert mit Kunststoff-Karaffen | martelé avec en plastique
8066.00213 Ø 35 cm / H 33 cm   670.35**Ersatzteile | Pièces de rechange**

8066.00204 Karaffe Glas / Carafe Verre 49.80

8066.00205 Karaffe Kunststoff / Carafe Plastique 49.80

8066.00214 Kugel mit Crasheisröhre poliert
Boule avec tube de glace crashé poli 458.558066.00215 Kugel mit Crasheisröhre gehämmert
Boule avec tube de glace crashé martelée 469.15FRILICH
THE ORIGINAL
EST. 1965**CARAFINE OAK «Trio»****Saftkanne****Pot à jus**Tragerl aus Eiche, Kunststoffeinsätze und Halterung für Kühlakkus,
Kühlakkus, Glasflaschen 1 Liter mit Milchmotiv und Stopfen
Porte-objets en chêne, inserts en plastique et support pour
accumulateurs de froid, accumulateurs de froid, bouteilles en verre
de 1 litre avec motif laitier et bouchons8066.00220 17 x 41 cm x H 44,5 cm   729.15**Nachfüllartikel | Recharges**8066.00221 1 L Glasflasche mit Stopfen   26.95

1 L Bouteille en verre avec bouchon

Ersatzteile | Pièces de rechange

8066.00222 Kühlakku / Accu de refroidissement 3.80

8066.00223 Kunststoffeinsatz schwarz / Insert en plastique noir 37.60

8066.00224 Tragerl aus Eiche / Porte en chêne 564.45

8066.00225 Steckschild aus Edelstahl 3 Stk mit indiv. Beschriftung
Panneau enfichable en inox 3 pièces avec inscription individuelle 105.80

service & buffet

FRILICH
THE ORIGINAL
EST 1965**RAISER OAK****Getränke-Set mit 9 Flaschen****Set de boissons avec 9 bouteilles**

Standfuss aus Eiche, Schale aus Edelstahl 18/10, mit 2 Kühlrippen, 9 Bügelflaschen aus Glas à 0,2 L

Pied en chêne, bac en inox 18/10, avec 2 ailettes de refroidissement, 9 bouteilles à étrier en verre de 0,2 L

8066.00230	23 x 23 x H 30 cm		351.50
8066.00231	23 x 23 x H 36 cm		469.15

Ersatzteile | Pièces de rechange

8066.00232	Bügelflasche / Bouteille à repasser 0,2 L	3.80
8066.00233	Standfuss / Socle 23 x 23 x H 10 cm	233.15
8066.00234	Standfuss / Socle 23 x 23 x H 16 cm	351.50
8066.00235	Edelstahlschale / Bac en inox 23 x 23 cm	93.85
8066.00236	Kühlrippen / Ailettes de refroidissement 23 x 23 cm	29.35

FRILICH
THE ORIGINAL
EST 1965**RAISER OAK****Getränke-Set mit 20 Flaschen****Set de boissons avec 20 bouteilles**

Standfuss aus Eiche, Schale aus Edelstahl 18/10, mit 3 Kühlrippen, 20 Bügelflaschen aus Glas à 0,2 L

Pied en chêne, bac en inox 18/10, avec 3 ailettes de refroidissement, 20 bouteilles à étrier en verre de 0,2 L

8066.00240	35 x 35 x H 26 cm		458.55
8066.00241	35 x 35 x H 36 cm		611.50

Ersatzteile | Pièces de rechange

8066.00232	Bügelflasche / Bouteille à repasser 0,2 L	3.80
8066.00242	Standfuss / Socle 33 x 33 x H 8 cm	269.80
8066.00243	Standfuss / Socle 33 x 33 x H 17 cm	411.50
8066.00244	Edelstahlschale / Bac en inox 33 x 33 cm	105.80
8066.00245	Kühlrippen / Ailettes de refroidissement 33 x 33 cm	34.80

FRILICH
THE ORIGINAL
EST 1965**RAISER VINTAGE****Getränke-Set mit 9 Flaschen****Set de boissons avec 9 bouteilles**

Standfuss aus Fichte mit weissem Lack in «used Look», Schale aus Edelstahl 18/10, mit 2 Kühlrippen, 9 Bügelflaschen aus Glas à 0,2 L

Pied en épicéa avec vernis blanc «used Look», bac en inox 18/10, avec 2 ailettes de refroidissement, 9 bouteilles à étrier en verre de 0,2 L

8066.00250	23 x 23 x H 30 cm		269.80
8066.00251	23 x 23 x H 36 cm		282.10

Ersatzteile | Pièces de rechange

8066.00232	Bügelflasche / Bouteille à repasser 0,2 L	3.80
8066.00252	Standfuss / Socle 23 x 23 x H 10 cm	116.35
8066.00253	Standfuss / Socle 23 x 23 x H 16 cm	116.35
8066.00235	Edelstahlschale / Bac en inox 23 x 23 cm	93.85
8066.00236	Kühlrippen / Ailettes de refroidissement 23 x 23 cm	29.35

FRILICH
THE ORIGINAL
EST 1965**RAISER VINTAGE****Getränke-Set mit 20 Flaschen****Set de boissons avec 20 bouteilles**

Standfuss aus Fichte mit weissem Lack in «used Look», Schale aus Edelstahl 18/10, mit 3 Kühlrippen, 20 Bügelflaschen aus Glas à 0,2 L

Pied en épicéa avec vernis blanc «used Look», bac en inox 18/10, avec 3 ailettes de refroidissement, 20 bouteilles à étrier en verre de 0,2 L

8066.00260	32 x 32 x H 30 cm		329.15
8066.00261	32 x 32 x H 36 cm		351.50

Ersatzteile | Pièces de rechange

8066.00232	Bügelflasche / Bouteille à repasser 0,2 L	3.80
8066.00262	Standfuss / Socle 33 x 33 x H 8 cm	131.70
8066.00263	Standfuss / Socle 33 x 33 x H 17 cm	139.80
8066.00244	Edelstahlschale / Bac en inox 33 x 33 cm	105.80
8066.00245	Kühlrippen / Ailettes de refroidissement 33 x 33 cm	34.80

FRILICH
THE ORIGINAL
EST. 1962**UNISON**
Saftkanne
Pot à jus

Saftkanne aus Edelstahl, transparenter Kunststoffbehälter aus SAN, Kühlakku im Edelstahlstandfuss, Edelstahlcrasheisröhre, Edeltropfschale, Edelstahl Hahn

Verseuse à jus en inox, récipient en plastique transparent en SAN, accumulateur de froid dans le pied en inox, tube à glace pilée en inox, égouttoir en inox, robinet en inox

8066.00280	2,5 L / 33,5 x 20,5 x H 43,5 cm			489.15
8066.00281	5 L / 37 x 23,5 x H 49 cm			529.15

Nachfüllartikel | Recharges

8066.00282	2,5 L			351.50
8066.00283	5 L			368.10

Ersatzteile | Pièces de rechange

8066.00284	2,5 L Deckel mit Griff / 2,5 L Couvercle avec poignée			49.80
8066.00285	5 L Deckel mit Griff / 5 L Couvercle avec poignée			58.55
8066.00286	2,5 L Behälter / 2,5 L Récipient			131.70
8066.00287	5 L Behälter / 5 L Récipient			152.70
8066.00288	2,5 L Crasheisröhre / 2,5 L Tube à glace crashé			69.85
8066.00289	5 L Crasheisröhre / 5 L Tube à glace crashé			82.10
8066.00109	Edelstahl-Hahn / Robinet en inox			198.85
8066.00290	Kühlakku / Accu de refroidissement			9.35
8066.00291	2,5 L Eiseneinsatz / 2,5 L Insert en métal			19.95
8066.00292	5 L Eiseneinsatz / 5 L Insert en métal			19.95
8066.00293	2,5 L Standfuss / 2,5 L Pied de support			164.45
8066.00294	5 L Standfuss / 5 L Pied de support			198.85
8066.00295	2,5 L Tropfschale / 2,5 L Bac de récupération			49.80
8066.00296	5 L Tropfschale / 5 L Bac de récupération			58.55
8066.00297	Tropfgitter / Grille-égouttoir			46.85

**TOP FRESH**
Milchdispenser
Distributeur à laitInox und weiss transparenter Kunststoff, Kanne aus Porzellan, inkl. Porzellanschild zum Beschriften, 1 Kühlakku rund
Inox et matière synthétique blanc-clair, récipient en porcelaine, avec panneau pour inscription, 1 accu rond de réfrigération

8582.10850	31 x 21 x H 42 cm / 4 l			439.00
------------	-------------------------	--	--	--------

Ersatz-Milchkanne | Récipient à lait porcelaine

8582.10825	Ø 18 x H 25 cm / 4 l			136.50
------------	----------------------	--	--	--------

Ersatz-Hahn | Robinet de rechange

8582.10907				51.70
------------	--	--	--	-------

sambonet

**ASIA 2000**
Samovar
SamovarElektrischer Selbstkocker für Kaffee/Tee, 230 V, Temperatur regelbar 0+100°
Autocuiseur électrique pour café ou thé, 230 V, Température réglable 0+100°**Inox**

58357E06	6 l	H 54 cm			1644.75
58357E09	9 l	H 60 cm			1875.00
58357E12	12 l	H 68 cm			2332.80

Versilbert nicht erhältlich | Modèle argenté pas livrable

service & buffet

**BRIDGE****Saftdispenser****Distributeur à jus de fruit**

Holz, Kühlung durch 2 Kühlakkus von oben und unten,

inkl. 3 Magnetschilder: ORANGE, APPLE und GRAPEFRUIT

Bois, 2 plaques de froid (1 dans le couvercle, 1 dans le socle)

incl. 3 signes magnétiques: ORANGE, APPLE et GRAPEFRUIT

Ahorn | Érable

8582.10870 4 L / 31,0 x 20,0 x H 42 cm  349.008582.10871 6 L / 35,5 x 22,0 x H 50 cm  445.60**BRIDGE****Saftdispenser****Distributeur à jus de fruit**

Holz, Kühlung durch 2 Kühlakkus von oben und unten,

inkl. 3 Magnetschilder: ORANGE, APPLE und GRAPEFRUIT

Bois, 2 plaques de froid (1 dans le couvercle, 1 dans le socle)

incl. 3 signes magnétiques: ORANGE, APPLE et GRAPEFRUIT

Wenge | Wengé

8582.10872 4 L / 31,0 x 20,0 x H 42 cm  349.008582.10873 6 L / 35,5 x 22,0 x H 50 cm  445.60**BRIDGE****Milchdispenser****Distributeur à lait**

Edelstahl Dispenser mit 1 Kühlakku im Standfuss, inkl. touchless adapter

Distributeur en acier inox avec 1 accumulateur de froid sans le socle et avec adaptateur sans contact manuel

Ahorn | Érable

8582.10836 3 L / 31 x 20 cm, H 39 cm  423.508582.10838 5 L / 39 x 22 cm, H 45 cm  670.50**BRIDGE****Milchdispenser****Distributeur à lait**

Edelstahl Dispenser mit 1 Kühlakku im Standfuss, inkl. touchless adapter



Distributeur en acier inox avec 1 accumulateur de froid sans le socle et avec adaptateur sans contact manuel



Wenge | Wengé

8582.10837 3 L / 31 x 20 cm, H 39 cm  423.508582.10839 5 L / 39 x 22 cm, H 45 cm  670.50



GOOD MORNING
Buffet-Ständer, 4-teiliges Set
Présentoir à céréales, Set de 4 pcs
Holzständer inkl. 3 Gläser mit luftdichtem Klapdeckel
Présentoir en bois, 3 bols en verre

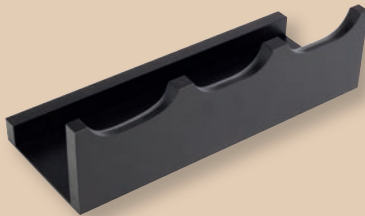

Ahorn | Érable
8582.14960 43 x 17 cm   115.80

Ersatzglas | Verre de rechange
7070.58244 2 L / H 21,6 cm   7.50





GOOD MORNING
Buffet-Ständer, 4-teiliges Set
Présentoir à céréales, Set de 4 pcs
Holzständer inkl. 3 Gläser mit luftdichtem Klapdeckel
Présentoir en bois, 3 bols en verre

Wenge | Wengé
8582.14965 43 x 17 cm   115.80

Ersatzglas | Verre de rechange
7070.58244 2 L / H 21,6 cm   7.50





BRIDGE
Besteckbehälter
Bac à couverts
2 teiliges Set: 1 Gestell, 1 Besteckbehälter herausnehmbar
set de 2: 1 support, 1 bac à couverts amovible

Ahorn | Érable
8582.13995 57,7 x 37 cm, H 12 cm   129.35





BRIDGE
Besteckbehälter
Bac à couverts
2 teiliges Set: 1 Gestell, 1 Besteckbehälter herausnehmbar
set de 2: 1 support, 1 bac à couverts amovible

Wenge | Wengé
8582.14995 57,7 x 37 cm, H 12 cm   129.35

service & buffet



WOODY
Holzbox
Base bois
Akazienholz, 4 Fächer
Bois d'acacia, 4 compartiments

8582.11649 36 x 14 x H 12,5 cm   23.50



ACACIA
Besteckbehälter
Range-couverts
Akazienholz natur, 4 Fächer (26 x 11,5 cm)
Bois d'acacia naturel, 4 compartiments (26x11,5cm)

8582.11952 51 x 28 cm x H 13 cm   70.55





ACACIA
Besteckbehälter mit Deckel
Range-couverts avec couvercle
Akazienholz natur, 4 Fächer (26 x 11,5 cm)
Bois d'acacia naturel, 4 compartiments (26x11,5cm)

8582.11949 51 x 28 cm x H 14,5 cm   112.30



Besteckbehälter GN 1/1
Corbeille à couverts GN 1/1
in Handarbeit geflochten, 4 Mulden, Kunststoff-Geflecht, Drahtgestell, braun-schwarz
cordelé à main, 4 creux, clayon en plastique, cadre en fil de fer, brun-noir

8582.11966 53,0 x 32,5 cm x H 9,0 cm   57.60





Besteckkasten mit Deckel
Range-couverts avec couvercle
Polypropylen
Polypropylène

8310.00890 51 x 28 cm x H 14,5 cm   28.20





Besteckkasten GN 1/1
Bac à couverts GN 1/1
 Kunststoff grau, stapelbar, spülmaschinenfest
 Matière synthétique gris, empilable, garantie au lave-vaisselle

8005.33321 GN 1/1 53 x 32,5 cm   11.70







Besteckkasten GN 1/1
Bac à couverts GN 1/1
 Kunststoff schwarz, stapelbar, spülmaschinenfest
 Matière synthétique noir, empilable, garantie au lave-vaisselle

8582.11954 GN 1/1, 53 x 32,5 x H 10 cm   11.70



Besteckständer
Support pour couverts



matt poliert
 poli mat

8582.11921 Ø 10 cm x H 10 cm   13.25
 8582.11922 Ø 12 cm x H 13,5 cm   17.40



Besteckbehälter
Support pour cylindres à couverts

Inox 18/10, 6 Löcher, Lieferung ohne Köcher
 Inox 18/10, 6 trous, livraison sans cylindres

8005.33701 37,5 x 30 cm x H 20 cm   136.50



Besteckköcher
Cylindres pour support à couverts

Kunststoff | Matière plastique

8005.33704   4.65









Inox

8005.33705   14.05

service & buffet









**Halter für Besteckboxen, 4 Stöckig****Support pour casiers à couverts, 4 étages**

Tiefe mit Boxen: 47 cm, Lieferung ohne Besteckboxen
profondeur avec casiers: 47 cm, Livraison sans casiers à couverts

für 4 Boxen/pour 4 casiers			
8335.00404	13,6 x 47 cm x H 49 cm	 	469.35
für 8 Boxen/pour 8 casiers			
8335.00408	26,0 x 47 cm x H 49 cm	 	498.85
für 12 Boxen/pour 12 casiers			
8335.00412	38,5 x 47 cm x H 49 cm	 	529.20
für 16 Boxen/pour 16 casiers			
8335.00416	51,5 x 47 cm x H 49 cm	 	564.65









**Halter für Besteckboxen, 3 Stöckig****Support pour casiers à couverts, 3 étages**

Tiefe mit Boxen: 41 cm, Lieferung ohne Besteckboxen
profondeur avec casiers: 41 cm, Livraison sans casiers à couverts

für 3 Boxen/pour 3 casiers			
8335.00303	13,6 x 47 cm x H 49 cm	 	351.70
für 6 Boxen/pour 6 casiers			
8335.00306	26,0 x 47 cm x H 49 cm	 	388.20
für 9 Boxen/pour 9 casiers			
8335.00309	38,5 x 47 cm x H 49 cm	 	388.20
für 12 Boxen/pour 12 casiers			
8335.00312	51,5 x 47 cm x H 49 cm	 	423.50





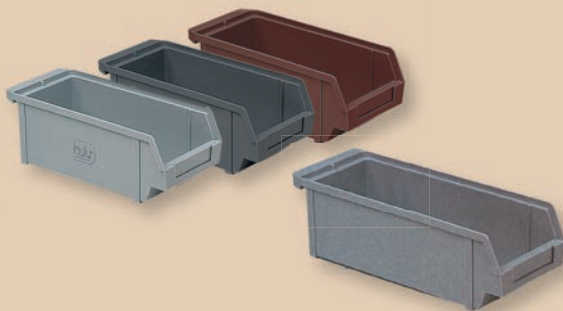

**Halter für Besteckboxen, 2 Stöckig****Support pour casiers à couverts, 2 étages**

Tiefe mit Boxen: 35 cm, Lieferung ohne Besteckboxen
profondeur avec casiers: 35 cm, Livraison sans casiers à couverts

für 2 Boxen/pour 2 casiers			
8335.00202	13,6 x 47 cm x H 49 cm	 	265.85
für 4 Boxen/pour 4 casiers			
8335.00204	26,0 x 47 cm x H 49 cm	 	294.05
für 6 Boxen/pour 6 casiers			
8335.00206	38,5 x 47 cm x H 49 cm	 	312.90
für 8 Boxen/pour 8 casiers			
8335.00208	51,5 x 47 cm x H 49 cm	 	312.90

**Besteckbox für ca. 60 - 80 Bestecke****Casier à couvert pour environ 60 - 80 couverts**

Temperaturbeständig - 30 bis +110° C, hochwertiger Kunststoff
résiste à la chaleur de -30 à +110° C, plastique de haute qualité









8335.00100	hellgrau/gris clair	 	19.75
8335.00101	anthrazit/anthracite	 	19.75
8335.00102	dunkelbraun/brun foncé	 	19.75

für extralange Besteckteile
pour couverts extra long

10 x 12,5 x 31,5 cm

8336.00010	dunkelgrau/gris foncé	 	23.50
------------	-----------------------	---	-------

**Einsteckschilder****Fiches assorties**

8335.00150	Gabel/Fourchette	 	4.90
8335.00151	Messer/Couteau	 	4.90
8335.00152	Löffel/Cuillère	 	4.90
8335.00153	Kaffeelöffel/Cuillère à café	 	4.90

sambonet



Flambierpfanne
Poêle à flamber

56163-27	Ø 27 cm	 	164.00
56163-30	Ø 30 cm	 	175.00

Versilbert auf Anfrage | Argenté sur demande

sambonet



Flambierrechaud
Réchaud à flamber

Lieferung ohne Gaskartusche
Livraison sans cartouche de gaz



56162-00	Ø 27,5 cm	H 21 cm	 	819.50
----------	-----------	---------	---	--------

Versilbert auf Anfrage | Argenté sur demande



KISAG «PowerFire®»
Rechaud zum Kochen
Réchaud pour cuire

Inox, komplett mit Gasdose, 2 Stunden Brenndauer,
Nennleistung 2,2 kW
Inox, complet avec bonbonne de gaz, 2 heures durée de combustion, puissance 2,2 kW

8005.30058	Ø 25 cm x H 9,5 cm	 	324.65
------------	--------------------	---	--------



KISAG «Kigas»
Nachfülldose
Bonbonne de rechange

Gasdose
Bonbonne de gaz

8005.31402	400 ml	 	6.55
8005.31403	600 ml	 	7.50

service & buffet



WMF «Hot & Fresh»
Chafing Dish GN 1/1
Chafing Dish GN 1/1

Cromargan®/Glas, GN 1/1, passend für Einsätze bis Tiefe 10 cm, Bodenmass: 47,5 x 27 cm, Glasdeckel mit Bremse abnehmbar, Griff 4-Kantprofil (matt), mit Brennstoff beheizbar, elektrisch beheizbar, induktionsgeeignet

Cromargan®/verre, GN 1/1, convient pour des inserts jusqu'à une profondeur de 10 cm, dimensions du fond: 47,5 x 27 cm, couvercle en verre avec frein amovible, poignée à profil carré (mat), peut être chauffé avec un combustible, chauffé électriquement, adapté à l'induction

55.0129.6040 58 x 47 x H 19 cm



1376.40



WMF «Hot & Fresh»
Chafing Dish GN 2/3
Chafing Dish GN 2/3

Cromargan®/Glas, GN 2/3, passend für Einsätze bis Tiefe 10 cm, Bodenmass: 27 x 30 cm, Glasdeckel mit Bremse abnehmbar, Griff 4-Kantprofil (matt), mit Brennstoff beheizbar, elektrisch beheizbar, induktionsgeeignet

Cromargan®/verre, GN 2/3, convient pour des inserts jusqu'à une profondeur de 10 cm, dimensions du fond: 27 x 30 cm, couvercle en verre avec frein amovible, poignée à profil carré (mat), peut être chauffé avec un combustible, chauffé électriquement, adapté à l'induction

55.0021.6040 37 x 45 x H 19 cm



917.60



WMF «Hot & Fresh»
Chafing Dish rund
Chafing Dish rond

Cromargan®/Glas, passend für Einsätze bis Tiefe 10 cm, Bodenmass: Ø 29 cm, Glasdeckel mit Bremse abnehmbar, Griff 4-Kantprofil (matt), mit Brennstoff beheizbar, elektrisch beheizbar, induktionsgeeignet

Cromargan®/verre, convient pour des inserts jusqu'à une profondeur de 10 cm, dimensions du fond: Ø 29 cm, couvercle en verre avec frein amovible, poignée à profil carré (mat), peut être chauffé avec un combustible, chauffé électriquement, adapté à l'induction

55.0020.6040 Ø 39 cm x H 19 cm



917.60



T13

Mono-Induktionskochplatte
Plaque à induction mono

04.1524.0011 1890-2205 W



93.85



T23

WMF «KultX»
Doppel-Induktionskochplatte
Plaque à induction double

04.1532.0011 3500 W



211.15



T13



Induktionskocher IK 20TC
Réchaud à induction IK 20TC

Induktionskochfeld aus Glas, Regulierung von Leistung/Temperatur und Zeit möglich, Steuerung mit Touch-Funktion, Temperaturbereich zwischen 60°C bis 240°C, Durchmesser Kochfeld 22,8 cm
Table de cuisson à induction en verre, réglage possible de la puissance/température et du temps, commande avec fonction tactile, plage de température entre 60°C et 240°C, diamètre de la table de cuisson 22,8 cm

8270.90073 33 x 40 x H 6,3 cm



234.05



Porzellaneinsatz Gastronorm
Intérieur en porcelaine gastronorm
passend in Chafing Dish von WMF
pour les chafing dishes de WMF

GN 1/1

60.3044.9990 7,3 L / 53 x 32,5 x H 6,5 cm



116.30

GN 1/2

60.3045.9990 3,3 L / 32,5 x 26,5 x H 6,5 cm



64.45

GN 2/3

60.3046.9990 4,65 L / 32,5 x 35,4 x H 6,5 cm



112.30

GN 1/3

60.3047.9990 1,9 L / 32,5 x 17,5 x H 6,5 cm



49.80



Porzellaneinsatz
Intérieur en porcelaine

passend in alle grossen runden Chafing Dish von WMF
pour tous les grands chafing dishes ronds de WMF

60.3072.9990 1tlg. / 3,75 L / Ø 33,5 x H 7 cm



86.90

60.3073.9990 2tlg. / 3,5 L / Ø 33,5 x H 7 cm



112.30

service & buffet

WMF



WMF «Fusintec Mineral»
Bratentopf mit Glasdeckel
Cocotte avec couvercle en verre

Dark Brass, geeignet für Induktion, Gas, Glaskeramik oder Halogen. Spülmaschinengeeignet aber Spülen per Hand empfohlen.
Dark Brass, convient pour induction, gaz, vitrocéramique ou halogène. Passe au lave-vaisselle, mais le lavage à la main est recommandé.

05.1457.5290	2,4 L / Ø 20 cm x H 8,5 cm			149.95
05.1467.5290	4,4 L / Ø 24 cm x H 10,5 cm			173.95

WMF



WMF «Fusintec Mineral»
Bratentopf mit Glasdeckel
Cocotte avec couvercle en verre

Platinum, geeignet für Induktion, Gas, Glaskeramik oder Halogen. Spülmaschinengeeignet aber Spülen per Hand empfohlen.
Platinum, convient pour induction, gaz, vitrocéramique ou halogène. Passe au lave-vaisselle, mais le lavage à la main est recommandé.

05.1458.5290	2,4 L / Ø 20 cm x H 8,5 cm			149.95
05.1468.5290	4,4 L / Ø 24 cm x H 10,5 cm			173.95

WMF



WMF «Fusintec Mineral»
Bratentopf mit Glasdeckel
Cocotte avec couvercle en verre

Rose Quartz, geeignet für Induktion, Gas, Glaskeramik oder Halogen. Spülmaschinengeeignet aber Spülen per Hand empfohlen.
Rose Quartz, convient pour induction, gaz, vitrocéramique ou halogène. Passe au lave-vaisselle, mais le lavage à la main est recommandé.

05.1459.5290	2,4 L / Ø 20 cm x H 8,5 cm			149.95
05.1469.5290	4,4 L / Ø 24 cm x H 10,5 cm			173.95

WMF



WMF
Porzellaneinsatz für Töpfe
Insert en porcelaine pour casseroles

17.7920.9801	Ø 20 cm x H 7,5 cm			34.65
17.7924.9801	Ø 24 cm x H 8,0 cm			49.35





WMF
Deckelhalter
Support de couvercle

8005.60430	12 cm x H 8 cm			52.90
------------	----------------	--	--	-------



GLOBE
Chafing Dish mit Glasdeckel
Chafing Dish avec couvercle en verre



Inox hochglanzpoliert, mit abnehmbarem hydraulischem Edelstahldeckel mit Glasfenster, Sandwichboden sorgt für optimale Wärmeverteilung, für alle Herdarten geeignet, inkl. Gestell, Wasserbecken, GN 1/1-65 Behälter, Löffelablage, 2 Brennpastenbehälter, Metallrahmen für Induktionskochplatte
Inox, poli miroir, avec couvercle amovible hydraulique en inox avec fenêtre en verre, fond sandwich pour une répartition de chaleur optimale, convient à toutes les cuisinières, incl. étagère, bassins, récipient GN 1/1-65, rangement de cuillers, 2 récipients de pâte combustible, cadre inox pour la plaque à induction

8582.12404 59 x 43,5 cm x H 34 cm   894.05



GLOBE
Chafing Dish rund mit Glasdeckel
Chafing Dish rond avec couvercle en verre

Inox hochglanzpoliert, mit abnehmbarem hydraulischem Edelstahldeckel mit Glasfenster, Sandwichboden sorgt für optimale Wärmeverteilung, für alle Herdarten geeignet, inkl. Gestell, Wasserbecken, Behälter, Löffelablage, Brennpastenbehälter, Metallrahmen für Induktionskochplatte
Inox, poli miroir, avec couvercle amovible hydraulique en inox avec fenêtre en verre, fond sandwich pour une répartition de chaleur optimale, convient à toutes les cuisinières, incl. étagère, bassins, récipient rond, rangement de cuillers, récipient de pâte combustible, cadre inox pour la plaque à induction

8582.12403 Ø 35, 50 x 45 cm x H 34 cm   822.30



PREMIUM
Chafing Dish
Chafing Dish





Gestell, Wasserbecken mit Sandwichboden, Wasserbeckenrahmen, Deckel mit hydraulischem Gelenk, GN 1/1 Behälter 65 mm tief, hitzebeständige Griffe, hochwertige Verarbeitung, ausschließlich für Induktionskochfelder
Pied support, bac bain-marie avec fond sandwich, cadre de bac d'eau, couvercle avec jointure hydraulique, Bac GN 1/1 65 mm creux, poignées résistants aux températures chauds, traitement de haute qualité, seulement pour induction

8582.12370 91 - 66 x 48 cm x H 33 cm   1175.05

Einzelteile | pièces détachées

Induktionskochplatte für Chafing Dish
plaque électrique induction pour chafing dish



8582.12295 900 W   211.55

service & buffet

PREMIUM
 Chafing Dish rund
 Chafing Dish rond



Gestell, Wasserbecken mit Sandwichboden, Wasserbeckenrahmen, Deckel mit hydraulischem Gelenk, runder Speisenbehälter, hitzebeständige Griffe, hochwertige Verarbeitung, für Induktionskochfelder geeignet

Pied support, bac bain-marie avec fond sandwich, cadre de bac d'eau, couvercle avec jointure hydraulique, récipient rond pour aliments, poignées résistants aux températures chauds, traitement de haute qualité, seulement pour induction

8582.12372 11 l / Ø 44 x 48 x H 33 cm   1057.40

Einzelteile | pièces détachées

Induktionskochplatte für Chafing Dish
 plaque électrique induction pour chafing dish

8582.12295 900 W   211.55

Speiseinsatz Inox
 Bac supérieur inox

8582.12397 10 L   29.30

GLOBE
 Suppentopf
 Pot à soupe

Inox, inkl. Speisenbehälter (ca. 10 Liter), mit einhängbarem Ablagetablett, Sandwichboden sorgt für optimale Wärmeverteilung, hitzeisolierende Griffe, Lieferung ohne Schöpfer



Inox, incl. récipient (env. 10 litres), avec plateau accrochable, le fond sandwich sert à la distribution de chaleur optimale, poignées anti-thermiques, livraison sans louche

8582.12399 10 l / ca. Ø 48 x H 32 cm   623.50

GLOBE
 Suppentopf inkl. Gestell
 Pot à soupe

Inox, inkl. Speisenbehälter, mit einhängbarem Ablagetablett, Sandwichboden sorgt für optimale Wärmeverteilung, hitzeisolierende Griffe, für alle Herdarten geeignet, inkl. Brennpastenbehälter

Inox, incl. récipient, avec plateau accrochable, le fond sandwich sert à la distribution de chaleur optimale, poignées anti-thermiques, convient pour tous fourneaux

8582.12398 10 l / Ø 48 x H 45 cm   741.15

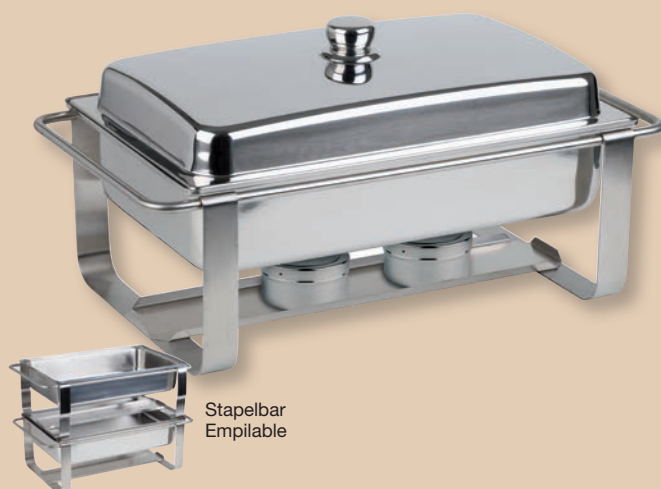

Stapelbar
Empilable

CATERERER PRO Chafing Dish Chafing Dish

Edelstahl rostfrei, stapelbar, Deckel spiegelblank poliert, 1 Wasserbecken inkl. Vorrichtung für Heizplatte, hochstellbarer Deckel, massiver Ständer, 2 Brennpastenbehälter.

Acier inoxydable, empilable, brillant poli, 1 bassin avec dispositif pour plaque électrique, couvercle relevable, support massif, 2 récipients pour pâte combustible.

8582.12233 64 x 35 cm x H 34 cm   230.50

Ersatzdeckel | Couvercle de rechange
8582.12236



  74.95

Elektro-Heizelement Corps de chauffage électrique

für mehrheitlich geschlossenen Chafing Dish
pour les bain-maries souvent fermés

8582.12290 360 Watt, 140 - 250 V   198.95



für mehrheitlich geöffneten Chafing Dish
pour les bain-maries souvent ouvertes

8005.30521 600 Watt, 230 V   198.95



Elektro-Heizelement mit einstellbarem Leistungsregler Corps de chauffage électrique avec réglage puissance

für mehrheitlich geöffneten Chafing Dish
pour les bain-maries souvent ouvertes

8582.12294 800 Watt, 230 V   272.90





T13



ELITE Chafing Dish rechteckig mit Rolltopdeckel Bain-marie rectangulaire avec couvercle rolltop

Edelstahl mit Rolltopdeckel, inkl. GN 1/1 Behälter (100 mm tief), elektrische Temperaturregelung, Elektro-Wasserbecken aus Kunststoff, 220-240 Volt / 50 Hz, 760-900 Watt

Acier inoxydable avec couvercle rolltop, incl. bac GN 1/1 (100 mm de profondeur), réglage de température électrique, bassin électrique en matière plastique, 220-240 Volt / 50 Hz, 760-900 Watt

8582.12360 11 l / ca. 67 x 47 x H 45 cm   647.00

service & buffet



T13

**Einbau-Induktionskochplatte**
Plaque électrique induction encastrable

inklusive Kabel-Fernbedienung, Leistung in 5 Stufen regelbar, 60°-240°C, mit Schott-Ceranglas, energiesparend

Incl. câble pour commande à distance, 5 degrés de réglage, 60° - 240°C, avec verre ceran de Schott, consomme peu d'énergie.









8582.12285 35,5 x 35,5 cm   317.60

T13

**Induktionskochplatte rund**
Plaque électrique induction encastrable ronde

geeignet für Chafing Dish/Suppenkugel «GLOBE», mit Regler, kann nur in Verbindung mit dem passenden Metallrahmen genutzt werden

Convient au Chafing Dish/boule à soupe «GLOBE» avec régulateur, à utiliser uniquement avec les cadres en métal assortis.

8582.12295 Ø 20 cm   211.55**Metallrahmen**
Cadres en métalgeeignet für Chafing Dish/Suppenkugel «GLOBE»
pour Chafing Dish/boule à soupe «GLOBE»8582.12296 für/pour 8582.12394   29.60
8582.12291 für/pour 8582.12393+8582.12399   28.20**«Swiss»**
Rolltopdeckel einzeln
Couvercle rolltop seulpassend für alle gängigen Chafing Dish
convient à tous Chafing Dish normale8005.30515 55 x 34 cm   151.50**Porzellaninsatz**
Bac supérieur en porcelainefür runde Chafing Dish
pour Chafing Dish ronds8582.82220 1tlg. / Ø 39 cm x H 6,5 cm   125.00
8582.82225 2tlg. / Ø 39 cm x H 6,5 cm   129.35

Chafing Dish Brenner
Brûleur à Chafing Dish

Inox 18/10

8005.30800 Ø 9 cm x H 6 cm



10.55

Brennpaste in Dose
Gel combustible en boîte

8005.30128 200 g



2.30

Brennpaste
Gel combustible
Eimer ohne Dispenser
Seau sans pompe

8005.30008 4 kg



34.65

Dispenser zu Brennpasteneimer
Pompe pour gel seaux combustible

8005.30009



22.95

Wärmesplit
Gravillon thermique

für Chafing Dishes, deutscher Granitsplitt mit feiner Körnung, hohe Wärmekapazität, kein Ankleben wie bei Therosalz, ideal zum Warmhalten von Eiern, Inhalt 4,5 l (7kg), reicht zum Befüllen eines GN 1/1 65 mm Einsatzes bis zu zwei Dritteln.

Pour Chafing Dishes, gravillon de granit allemand à fin grenage, haute conductibilité thermique, ne colle pas, idéal pour tenir les œufs au chaud, contenu 4,5 l (7kg), suffit pour remplir un GN 1/1 65 jusqu'au deux tiers.

8005.03810 hellgrau/gris clair



32.90

8005.03811 rot/rouge



32.90

8005.03812 gelb/jaune



32.90

Spring

SPRING «Caldor»
Thermisches Granulat
Granulat thermique

Wiederverwendbares, thermisches Granulat zum Warmhalten von gekochten Eiern, für den Einsatz in Chafing Dishes.

Granulat thermique réutilisable, pour tenir au chaud des oeufs cuits, utilisable dans des bainsmaries.

8664.00200 5 kg



57.60



trolleys & tables

sambonet

**NEW YORK****Serviertrolley/-wagen****Chariot à servir**

Obere Platte mit Metallumrandung

Plaque supérieure avec encadrement en métal

Wenge | Wengé

58791-00 120 x 58,5 x H 101 cm



5870.00

Eiche | Chêne

58791R00 120 x 58,5 x H 101 cm



6468.20

Sonderausstattung
Équipement spécialKantenschutz
Protection des bords

58791-AL



149.80

Superelastische Rollen mit 2 Feststellbremsen
Roulettes super souples avec 2 freins

58786-AC



469.00

Auf Anfrage:

Schublade mit Knauf, abnehmbare untere Platte mit Knauf, mittlere Platte, Ablage aus Metall

Sur demande:

Tiroir avec bouton, plateau inférieur amovible avec bouton, plateau au milieu, rangement en métal

sambonet

**NEW YORK****Wein- und Likörwagen****Chariot à vin et liqueur**

3 Flaschenkühler, 1 Tablett, obere Platte mit Flaschen- und Gshalterring, untere Platte mit Flaschengestell, hölzernes Ablagefach

3 rafraîchisseurs de vin, 1 plateau, plateau supérieur avec étagère pour bouteilles et verres, plateau inférieur avec étagère pour bouteilles, rayon en bois

Wenge | Wengé

58791-30 120 x 58,5 x H 101 cm



7850.00

Eiche | Chêne

58791R30 120 x 58,5 x H 101 cm



8939.70

Sonderausstattung
Équipement spécialKantenschutz
Protection des bords

58791-AL



149.80

Superelastische Rollen mit 2 Feststellbremsen
Roulettes super souples avec 2 freins

58786-AC



469.00

Auf Anfrage:

Ablage aus Metall

Sur demande:



Rangement en métal



trolleys & tables

sambonet

**NEW YORK****Flambiertrolley
Chariot à flamber**



Schränkchen mit Schublade, piezoelektrische Zündvorrichtung, Sicherheitsvorrichtung zum Ausschalten, Lieferung ohne Gasflasche
Petite armoire avec tiroir, dispositif d'allumage piézo-électrique, dispositif de sécurité pour éteindre, livraison sans bobonne de gaz

Wenge | Wengé
58791-10 120 x 58,5 x H 94 cm   9875.00

Eiche | Chêne
58791R10 120 x 58,5 x H 94 cm   11'480.00

Sonderausstattung
Equipement spécial

Kantenschutz
Protection des bords
58791-AL   149.80

Superelastische Rollen mit 2 Feststellbremsen
Roulettes super souples avec 2 freins
58786-AC   469.00

Auf Anfrage: Ablage aus Metall
Sur demande: Rangement en métal



**Flambierpfanne
Poêle à flamber**



56163-27 Ø 27 cm   164.00
56163-30 Ø 30 cm   175.00

sambonet

**NEW YORK****Kühlrolley
Chariot refroidissant**

Für Einlage von eutektischen Platten
Pour insérer des plateaux eutectiques

Wenge | Wengé
58791-20 120 x 58,5 x H 108 cm   8223.15

Eiche | Chêne
58791R20 120 x 58,5 x H 108 cm   9875.00

Sonderausstattung
Equipement spécial

Kantenschutz
Protection des bords
58791-AL   149.80



Superelastische Rollen mit 2 Feststellbremsen
Roulettes super souples avec 2 freins
58786-AC   469.00



Auf Anfrage:
Ablage aus Metall

Sur demande:
Rangement en métal

sambonet



TOKYO
Beistelltisch, Standard
Chariot guéridon, Standard

Wenge | Wengé
 58786-00 85 x 50 x H 75 cm   2332.80

Eiche | Chêne
 58786R00 85 x 50 x H 75 cm   2332.80

Sonderausstattung
Equipement spécial

Kantenschutz
 Protection des bords
 58791-AL   149.80



Superelastische Rollen mit 2 Feststellbremsen
 Roulettes super souples avec 2 freins
 58786-AC   469.00



Auf Anfrage:
 Verchromte Griffe, Schublade mit Knauf, abnehmbare obere Platte
 mit Knauf, Ablage aus Metall

Sur demande:
 Poignée chromée, tiroir avec bouton, plateau supérieur amovible
 avec bouton, rangement en métal

sambonet

TOKYO
Champagnerrolley
Chariot à vin/champagne
 Mit Punchbowle und Gläserhalter
 Avec bol à punch et rack à verres

Wenge | Wengé
 58786-40 85 x 50 x H 91 cm   3980.00

Eiche | Chêne
 58786R40 85 x 50 x H 91 cm   4690.00

Sonderausstattung
Equipement spécial

Kantenschutz
 Protection des bords
 58791-AL   149.80

Superelastische Rollen mit 2 Feststellbremsen
 Roulettes super souples avec 2 freins
 58786-AC   469.00

Auf Anfrage:
 Verchromte Griffe, Regal aus Metall

Sur demande:
 Poignée chromée, porte assiettes en métal

trolleys & tables

sambonet



TOKYO

Beistelltisch Deluxe

Chariot guéridon, Deluxe

Abnehmbare obere Platte mit Knauf, Besteckfach

Plateau supérieur amovible avec bouton, casier pour couverts

Wenge | Wengé

58786-10 85 x 50 x H 75 cm



3980.00

Eiche | Chêne

58786R10 85 x 50 x H 75 cm



4690.00

Sonderausstattung
Equipement spécial

Kantenschutz

Protection des bords

58791-AL



149.80

Superelastische Rollen mit 2 Feststellbremsen
Roulettes super souples avec 2 freins

58786-AC



469.00

Auf Anfrage:

Verchromte Griffe, Schublade mit Knauf, Ablage aus Metall

Sur demande:

Poignée chromée, tiroir avec bouton, rangement en métal

sambonet



TOKYO

Kühlrolley

Chariot refroidissant

Für Einlage von eutektischen Platten

Pour insérer des plateaux eutectiques

Wenge | Wengé

58786-20 85 x 50 x H 101 cm



5198.00

Eiche | Chêne

58786R20 85 x 50 x H 101 cm



5875.00

Sonderausstattung
Equipement spécial

Kantenschutz

Protection des bords

58791-AL



149.80

Superelastische Rollen mit 2 Feststellbremsen
Roulettes super souples avec 2 freins

58786-AC



469.00

Auf Anfrage:

Verchromte Griffe, Ablage aus Metall

Sur demande:

Poignée chromée, rangement en métal

sambonet



TOKYO
Beistelltisch, klappbar
Chariot guéridon, Table pliante

Wenge | Wengé

58786-70 70 x 45 x H 70 cm



698.00

58786-90 70 x 45 x H 90 cm



764.00

Sonderausstattung
Équipement spécial

Kantenschutz
Protection des bords

58791-AL



149.80



Servierwagen
Table de service

Gestell Stahlrohr, pulverbeschichtet in Silber Feinstruktur. Seitenprofile aus Massivholz, gebeizt und lackiert. Einlegeböden aus kunststoffbeschichteten Platten mit Holzdekor wenge.

Piètement en tube d'acier, poudré en fine structure d'argent. Profils latéraux en bois massif, teintés et laqués. Tablettes en panneaux à revêtement synthétique avec ornements en bois wengé.

8392.00027 115 x 53,5 cm x H 97 cm



3798.80



Digestifwagen
Chariot à liqueurs

Gestell Stahlrohr, pulverbeschichtet in Silber Feinstruktur. Seitenprofile aus Massivholz, gebeizt und lackiert. Einlegeböden aus kunststoffbeschichteten Platten mit Holzdekor wenge.

Piètement en tube d'acier, poudré en fine structure d'argent. Profils latéraux en bois massif, teintés et laqués. Tablettes en panneaux à revêtement synthétique avec ornements en bois wengé.

8392.00028 115 x 53,5 cm x H 97 cm



4340.00

trolleys & tables



Servierwagen
Table de service

Abstellfläche mit Kunstharzbelag
Desserte en résine synthétique

8075.00010 85 x 50 x 78 cm

3410.00



CADDIE
Servierwagen, 2 Borde
Table de service, 2 niveaux

Er sieht nicht nur edel aus, sondern ist gleichzeitig äusserst stabil und funktionell durchdacht. Verchromte Rahmenstruktur, Holzeta- gen melaminharzbeschichtet, 12 Dekore zur Auswahl, 2 Etagen mit verchromter Reling, Zuladung 50 kg pro Tablar, 4 Lenkrollen Ø 100 mm mit Abweisingen, davon 2 Bremsrollen.

Le design est sophistiqué, sa structure est à la fois solide, discrète et élégante. Structure en tubes d'acier fi nition chromée, étagères en bois mélaminé, 12 coloris disponibles, 2 niveaux avec barres de retenion en finition chromée, charge utile 50 kg par étagère, 4 roulettes pivotantes Ø100 mm avec pare-chocs angulaires.

2 Borde | 2 Bords

8490.020xx 89 x 47 x H 94,5 cm / 22 kg 741.15

3 Borde | 3 Bords

8490.030xx 89 x 47 x H 94,5 cm / 25 kg 882.30

Weitere Farben auf Anfrage.
Autres couleurs sur demande.

15

12



Falttisch rollbar
Table pliante

Gestell Stahl pulverbeschichtet silber, Platte in Holzdekor Mooreiche, 4 Doppellenkrollen mit Feststeller Ø 125 mm. Mit wenigen Handgriffen ist der Tisch aufgestellt. Der Tisch rollt im zusammen- gefalteten Zustand stabil und steht offen fest und sicher. Tragkraft 50 kg.

Châssis en acier thermolaqué couleur argent. Plateau décor bois de chêne des marais. 4 roues pivotantes avec frein Ø 125 mm. Une simple manipulation et la table est installée. Déplacement facile et stable en toute sécurité même si le plateau est replié ou en position ouverte. Capacité de charge 50 kg.

8392.00065 90 x 57,7 x H 81 cm / 20 kg 822.30





Zimmerservicewagen Table de service en chambre

Gestell Stahl pulverbeschichtet, Platte kunststoffbeschichtet mit Holzdekor, 2 Seiten abklappbar
Cadre en acier porphérysé, plateau plaqué synthétique avec décor bois, 2 côtés rabattables



Buche oval / hêtre ovale

8392.00012 80 x 80 x H 74 cm   822.30



Mahagoni oval / acajou ovale

8392.00013 80 x 80 x H 74 cm   822.30

Buche quadratisch / hêtre carrée

8392.00014 80 x 80 x H 74 cm   764.65

Mahagoni quadratisch / acajou carrée



8392.00015 80 x 80 x H 74 cm   764.65





Beistelltisch Table gigogne

Gestell Stahl pulverbeschichtet, Platte kunststoffbeschichtet mit Holzdekor, 4 Lenkrollen mit Sperre Ø 7,5 cm.
Cadre acier pulvérisé, plateaux plaques synthétiques avec décor bois, 4 roues directices avec frein, Ø 7,5 cm.

Buche / hêtre

8392.00020 80 x 40 cm x H 74 cm / 11 kg   635.25

Mahagoni / acajou



8392.00021 80 x 40 cm x H 74 cm / 11 kg   635.25



Beistelltisch, stapelbar Table gigogne, empilable

Gestell Aluminiumrohr, Platte kunststoffbeschichtet mit Holzdekor. Alle 4 Rohrenden haben höhenverstellbare Kunststoffgleiter, damit können Bodenunebenheiten ausgeglichen werden.
Cadre en tube d'alu, plateaux plaques synthétiques avec décor bois, tous pieds des dules sont réglables en hauteur pour niveler les sols inégaux.

Buche / hêtre

8392.00022 80 x 40 cm x H 75 cm / 11 kg   458.60

Mahagoni / acajou

8392.00023 80 x 40 cm x H 75 cm / 11 kg   458.60

trolleys & tables

CADDIE «Flip Top»
 Zimmerservicetisch
 Table de restauration en chambre

Die Besonderheiten des Zimmerservicetisch FLIP TOP sind der besonders platzsparende Klappmechanismus der Tischplatte, seine Stapelbarkeit sowie die hochwertige Walnuss-Optik der Oberfläche. Ø 90 cm Platte aus laminiertem Schichtholz in der Farbe graphit, kratzfest und rutschhemmende Oberfläche, verchromtes Untergestell für den Transport von bis zu 2 HOT BOXen gleichzeitig, abklappbare Seitenteile, gesamte Tischplatte senkrecht abklapp- und arretierbar, daher platzsparend ineinander schiebbar, 4 Lenkrollen Ø125 mm, davon 2 Bremsrollen
 Les secrets de la TABLE FLIP TOP sont son plateau avec mécanisme de basculement, ses côtés rabattables (pour un encombrement très réduit) et son plateau très résistant et d'excellente qualité. Plateau Ø 90 cm en bois fibres à densité compacte finition coloris anthracite, à l'épreuve des rayures et anti-dérapant, structure en tubes d'acier chromé, peut porter 2 HOTBOX, côtés rabattables (facilite le passage des portes), plateau basculant (faible encombrement), 4 roulettes pivotantes Ø125 mm, dont 2 avec frein

8490.00045 Ø 90 cm x H 78,6 cm / 15 kg 1352.90



T13

CADDIE «Hot Box»
 Wärmebox
 Caisson chauffant

Die elektrische Wärmebox HOT BOX (500W) ist komplett aus Edelstahl gefertigt und hat isolierte Wände. Mit Analog-Thermostat (30° - 90°C). Tür- und Tragegriffe aus Kunststoff für eine sichere Handhabung, 2 höhenverstellbare Gittereinlegeböden, Türen mit Magnet-Verschluss, für Teller bis Ø 32 cm geeignet, passend für die Roomservice-Tische Easy, Flip Top und Compact XS
 La HOTBOX électrique dispose d'une structure et d'une porte complètement isolées en inox. Un thermostat permet de régler la température (30°-90°C). Poignées en matériau plastique 1 sur la partie supérieure, 1 sur la partie frontale et 1 sur chaque côté, 2 étagères ajustables en fil d'acier, porte aimantée, assiettes jusqu'à Ø32 cm, compatible avec les tables room service Easy, Flip top et Compact XS

220 V / 0,5 kW

8490.00055 38 x 40,5 x H 51,2 cm/ 18 kg 1352.90

CADDIE «Hot Box Taxi»
 Regal für Wärmeboxen
 Ôtagère pour caissons chauffant

Das BOX TAXI ist die fahrbare Aufbewahrung aus Edelstahl für bis zu 6 Wärmeboxen (HOT BOX), mit 2 Etagen, inklusive Stromanschlüssen für jeden Standplatz. Zuladung max. 150 kg, 4 Lenkrollen Ø125 mm mit Abweisingen, davon 2 Bremsrollen
 BOX TAXI, l'étagère mobile en inox pour transporter et mettre en température jusqu'à 6 HOT BOX simultanément, vous garantit également un stockage sécurisé et propre des caissons lorsque ceux-ci ne sont pas utilisés. Entièrement réalisé en acier inoxydable, avec 2 niveaux, charge utile max. 150 kg, 4 roulettes pivotantes de Ø125mm dont 2 avec frein, pare-chocs angulaire



8490.00060 146,7x56,2xH136,3 cm/30kg 2188.00



Service- und Kaffeestation
Station pour le service et café

Ausführung in Mattschwarz. Der Wagen ist ausgestattet mit einem Liebherr-Kühlschrank mit Umluftkühltechnik, mit einer Isolierglas-türe mit Edelstahlrahmen, abschliessbar. Der Innenraum ist mit einer schaltbaren LED-Beleuchtung und 2 Ablagerosten ausgestattet. Weitere Farben auf Anfrage.

Finition noir mat. Le chariot est équipé d'un réfrigérateur de marque Liebherr avec réfrigération par circulation d'air, porte vitrée isolante et cadre en acier inoxydable, verrouillable. L'intérieur du chariot est doté d'un éclairage LED commutable et de 2 grilles de rangement. D'autres couleurs sont disponibles sur demande.

8392.00025 160 x 74 x H 90 cm / 140 kg   7527.90



Getränke- und Servicewagen
Chariot à service et boissons

Ausführung in Buche/Silber. Die Basisplatten sind durch ein stabiles Stahlgestell miteinander verbunden. 3 Schubladen, eine davon mit Besteckensatz. Über die 3-fach Steckdose an der Innenwand können weitere Geräte angeschlossen werden. Der Wagen ist ausgestattet mit einem Liebherr-Kühlschrank mit Umluftkühltechnik, mit einer Isolierglas-türe mit Edelstahlrahmen, abschliessbar. Der Innenraum ist mit einer schaltbaren LED-Beleuchtung und 2 Ablagerosten ausgestattet.

Finition en bois de hêtre et argent. Les plaques de base sont reliées entre elles au moyen d'un cadre en acier stable. 3 tiroirs, dont un avec bac à couverts. La multiprise à 3 entrées située sur la paroi intérieure permet de brancher plusieurs appareils supplémentaires. Le chariot est équipé d'un réfrigérateur de marque Liebherr avec réfrigération par circulation d'air, porte vitrée isolante et cadre en acier inoxydable, verrouillable. L'intérieur du chariot est doté d'un éclairage LED commutable et de 2 grilles de rangement.



8392.00026 80 x 66 x H 120 cm / 100 kg   6398.80



Servicestation, wetterfest
Chariot de service résistant aux intempéries

Korpus anthrazit, Kanten schwarz, 2 Lenkrollen mit Sperre und 2 Lenkrollen ohne Sperre, Besteckschublade, 2 Flügeltüren, 1 Fachboden

Corps anthracite, côtes noir, 2 roues avec freins et 2 roues sans freins, tiroir pour couverts, 2 portes à deux battants, 1 étagère de fond

8392.00010 81,5 x 52 x H 100 cm / 70 kg   4635.00



Bärenstark
très robuste

trolleys & tables

Servicestation, wetterfest
Chariot de service résistant aux intempéries

Stabiles Edelstahlgestell pulverbeschichtet, 1 Besteckschublade, 1 Flügeltüre, 1 Fachboden

Etagèret solide en acier inoxydable, revêtement poudré, 1 tiroir pour couverts, 1 portes à deux battants, 1 rayon de fond

Grau | Gris

8392.00030 112 x 53,5 x H 107 cm

6398.80

Service- und Kaffeestation
Station pour le service et café

Stabiles Stahlrohrgestell, Holzausstattung anthrazit, Seitenwände einzeln austauschbar, Flügeltüren mit Stangenschloss, 1 Fachboden höhenverstellbar, Galerie aus Stahlrohr 25 mm pulverbeschichtet

Etagère tubulaire solide, équipement en bois anthracite, parois latérales interchangeables, portes à deux battants avec serrure à tiges, 1 rayon de fond réglable en hauteur, galerie en tube d'acier, revêtement poudré 25 mm.

8392.00040 104 x 62,5 x H 105 cm

3289.90

Auszug-Schublade

8392.00041

378.80

Getränkekistenbord schräg

8392.00042

343.50

Bankett- und Servicewagen
Chariot à banquet/service

Gestell schwarz, Holzausstattung anthrazit, 2 Fachböden höhenverstellbar

Etagère noir, équipement en bois anthracite, 2 rayons de fond réglables en hauteur.

8392.00035 111 x 63 x H 130 cm

2493.85



Gurtabsperpfosten Poteau pour zone interdite avec sangle

aus Edelstahl, mit selbstaufrollendem blauen 2 m-Gurtband in Kassette, 3 Einhängemöglichkeiten für Endstücke anderer Pfosten, Grundplatte mit Aussparung zum platzsparenden Lagern

en inox, avec cassette de ruban bleu 2m enrouleur automatique, 3 possibilités d'accrochage pour d'autres poteaux, plaque de sol avec place pour stockage.

Gurtabsperpfosten (einzeln) | Poteau avec sangle (seul)

8006.91944	Ø 35 x H 95 cm	blau/bleu			115.85
8006.91946	Ø 35 x H 95 cm	rot/rouge			115.85
8006.91947	Ø 35 x H 95 cm	schwarz/noir			115.85

Wandhalterung mit Gurt | Crochet avec sangle

8006.91945		blau/bleu			35.15
8006.91948		rot/rouge			35.15
8006.91949		schwarz/noir			35.15



Schild auf Absperrpfosten Panneau sur poteau pour zone interdite

aus Edelstahl, zum einfachen Aufstecken auf Absperrpfosten mit Zugband, DIN A4-Blätter können in den Rahmen zwischen zwei Acryl-Scheiben eingeschoben werden, beidseitig lesbar

En acier inoxydable, pour une montage facile, avec tirant, des feuilles A4 DIN peuvent être inséré dans le cadre (entre deux vitres acryliques), lisible des deux côtés

8006.91950	Ø 8,5 cm x H 6 cm / DIN A4			65.85
------------	----------------------------	--	--	-------

Absperrpfosten Poteau pour zone interdite

aus Edelstahl, hochglänzend, mit schwerer Bodenplatte (Ø 31 cm), dazu erhältliches Seil, rot, samtummantelt und mit verchromten Verschluss

en inox, brillant, avec plaque de sol lourde (diam. 31cm), cordes disponibles, gainées velours, rouge, fermeture chromée.

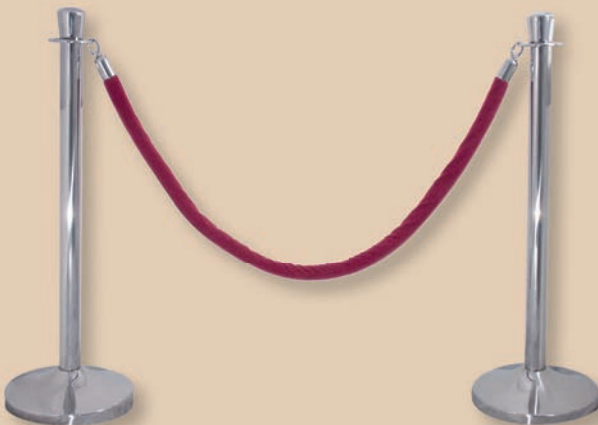

Absperrpfosten (einzeln)/Poteau (seul)

8006.91940	Ø 5 x H 95 cm			105.40
------------	---------------	--	--	--------



Absperrseil samtummantelt | Cordes gainées velours

8006.91941	Ø 3 x L 150 cm	rot/rouge			25.85
8006.91942	Ø 3 x L 250 cm	rot/rouge			31.70



Absperrseil, gewunden | Corde barrage contournée

8006.91957	Ø 3 x L 150 cm	blau/bleu			45.85
8006.91958	Ø 3 x L 150 cm	schwarz/noir			45.85



Wandhaken/Crochet

8006.91943				11.70
------------	--	--	--	-------

■ livecookintable®



Livecookintable®



**Das erste modulare und tragbare Live-Cooking-Möbel.
Direkt aus der Tragetasche!**

Elegantes Design, hochwertige Oberflächen und einzigartige Muster. Es sieht aus wie eine Luxus-Haushaltsküche und ist tatsächlich eine neue Lösung für die Gastronomie. livecookintable® setzt den Standard: Baukastensystem, austauschbare Kochfelder, leichte Montage ohne Werkzeug und eine intuitive Bedienung. Einfacher Transport in Taschen und Rollkoffern: Self-Service Buffet, Casino, Live-Cooking-Station, Restaurant, Bar, Chef's Table, Kochkurse, Event Catering, Lounges, Lunch, Buffet, Tastings, Dinner, Kongresszentren, Messen, Sport- und Multifunktions-Arenen, Hotels und Gastronomie.

Le premier meuble modulaire et transportable Live-Cooking. Directement du sac!

Design élégant, surfaces de qualité supérieure et décoration unique. Il a l'air d'une cuisine de luxe et est réellement une nouvelle solution pour la gastronomie. livecookintable® fixe le standard : système de meubles modulaire, plans de cuisson interchangeables, montage facile sans outil et une utilisation intuitive. Transport facile dans son sac et coffre roulettes: Buffets self-service, casino, restaurant, bar, table chefs, cours de cuisine, eventcatering, lounges, lunch, buffet, dégustations, dinner, centre de congrès, foires, meetings de sports, hôtels et gastronomies.



Die Möglichkeiten, welche das System Live Cooking Table bietet sind beinahe unbegrenzt. Gerne beraten wir Sie persönlich. In unserem Showroom können Sie auch eine Kombination besichtigen.

**Für detaillierte Informationen besuchen Sie:
www.berndorf.ch**

Les possibilités offertes par le système Live cooking table sont innombrables. Nous vous conseillons volontiers personnellement. Vous pouvez également découvrir une présentation de ce système dans notre showroom.

**Pour plusieurs informations visitez:
www.berndorf.ch**

Livecookintable

«Table Set Professional»



Professional 3 Professional 4 Professional 5

Als Basiselement jedes livecookintable® dient ein Tischrahmen, erhältlich in drei Grössen von 1,2 m bis 2 m. In den 3 Tischrahmen können alle Geräte frei und flexibel eingehängt werden, sei es zum Kochen, zum Kühlen, zum Grillieren, zum Wärmen oder Kochen mit dem Wok. Innerhalb eines Tischgestells haben 3, 4 oder 5 Segmente - Tischplatten oder Kochgeräte - platz. Die Elemente sind Gastro-Norm-kompatibel. Mithilfe der Segmentstege können Tischplatten in verschiedenen Grössen eingesetzt werden, so kann, ein perfekt auf die eigenen Bedürfnisse abgestimmter Arbeitsbereich geschaffen werden. Die Tische können problemlos ohne Werkzeug zusammengebaut und auseinander genommen werden. Transportieren lassen sich die Teile in praktischen Tragetaschen, welche auch in einen PW passen.

Un cadre de table disponible dans trois tailles de 1,2 m à 2 m sert d'élément de base pour chaque livecookintable®. Tous les appareils peuvent être accrochés librement et de manière modulaire dans les 3 cadres de table, que ce soit pour cuire, refroidir, griller, réchauffer ou cuire au wok. Un cadre de table peut accueillir 3, 4 ou 5 parties (plans de travail ou appareils de cuisson). Les éléments sont compatibles Gastro Norm. Les entretoises permettent l'installation de plans de travail de différentes tailles, pour un espace de travail parfaitement adapté aux besoins de chacun. Les plans peuvent être facilement montés et démontés sans outil. Les éléments peuvent être transportés dans des sacs pratiques tenant aussi dans une voiture.

Die Tischplatten sind in verschiedenen Standardfarben erhältlich. Eine aktuelle Farbübersicht finden Sie im Livecookintable-Katalog: www.berndorf.ch/de/produkte/kataloge

Les plateaux de table sont disponibles en différentes couleurs standard. Vous pouvez trouver les couleurs disponibles dans le catalogue Livecookintable: www.berndorf.ch/fr/produits/catalogues

«Buffet Blind 5»

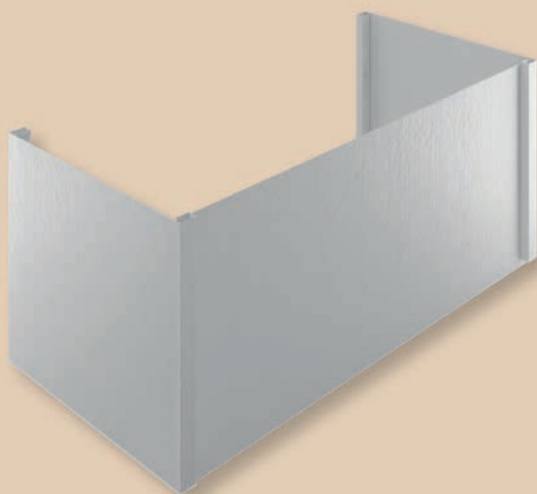

Zur Tischgrösse Professional 5 ist eine Blende erhältlich, die direkt an den Tischbeinen befestigt werden kann. Die Innenseite besteht ebenfalls aus leicht zu reinigenden MDF-Platten und der Überzug ist mit innenliegenden Reissverschlüssen zu befestigen. Die Standardfarben bei dieser Blende sind birke, anthrazit und weiss.

Pour le modèle Professional 5, il existe un cache qui peut être fixé directement aux pieds de la table. La face interne est également composée de panneaux MDF faciles à nettoyer et le revêtement se fixe à l'aide de fermetures à glissière intérieures. Pour ce cache, les couleurs standard sont bouleau, anthracite et blanc.

Die Blende ist in verschiedenen Standardfarben erhältlich. Eine aktuelle Farbübersicht finden Sie im Livecookintable-Katalog: www.berndorf.ch/de/produkte/kataloge

La éléments de cache sont disponibles en différentes couleurs standard. Vous pouvez trouver les couleurs disponibles dans le catalogue Livecookintable: www.berndorf.ch/fr/produits/catalogues



«Buffet Table Set Moove 4»

Das Set Moove 4 besteht aus einem Gestell mit Rädern, einem Tischrahmen und 4 Tischplatten, Segmentstegen und Elektroleiste. Die Front und Seiten werden mit festen Paneelen aus MDF-Platten abgedeckt. Diese Platten, überzogen mit Kunstleder-Stoffen, werden in den montierten Clip-in-Rahmen gesteckt und können somit auch ohne Werkzeug und Vorkenntnisse montiert werden. Standardmässig kommen die Blenden in 3 Farben, weiss, birke und anthrazit. Für ein individuelles Design können die Stoffe auch je nach Kundenwunsch bedruckt werden.

Le kit moove 4 se compose d'une structure sur roues permettant, d'un cadre de table et de 4 plans de travail, entretoises et plinthes techniques. L'avant et les côtés sont fermés à l'aide de panneaux MDF fixes. Ces panneaux, recouverts de tissu/similicuir, sont enfilés dans le châssis enclipsable et peuvent ainsi être montés sans outils et sans connaissance spécifique.

Les caches sont disponibles de série dans 3 couleurs: blanc, bouleau et anthracite. Pour un style personnalisé, le tissu peut aussi être imprimé selon les spécifications du client.

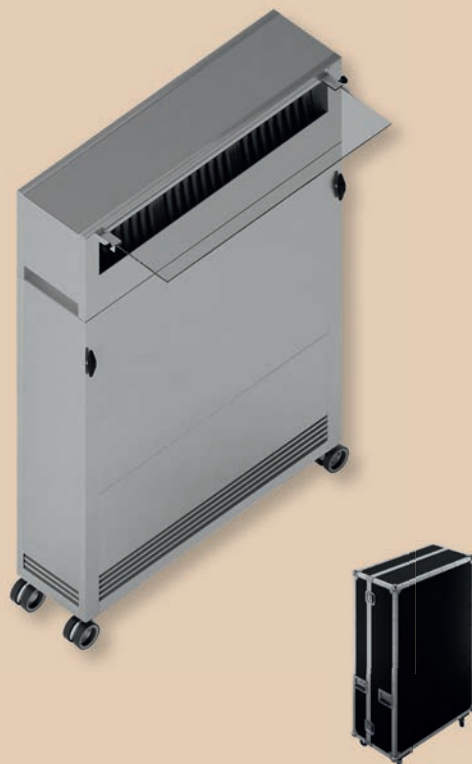

«Airwall 15»

Der neueste Stand der Technik: Raumluftreinigung mit Plasma Filter. Vier Filterstufen zur geruchsfreien und fettfreien Abluft. Raumluftreinigung mit integriertem Wrasenleitschirm aus Glas. Innovativer plasmaNorm® Filter zur Auflösung von Gerüchen. Wartungsfrei bis 2.500 Arbeitsstunden. Streckmetall-Fettfilter zur Luftvorreinigung. Lüfterleistung von 755 m³/h, Reinigungsvolumen ca. 48 m³/h. Oberfläche Edelstahl.

Une technologie de pointe: la purification de l'air ambiant par filtre à plasma. Quatre niveaux de filtration garantissent une évacuation d'air sans odeurs ni graisse, pour une réduction significative de la charge bactérienne. Epuration de l'air avec panneau de guidage de vapeur en verre. Filtre innovant plasmaNorm® pour l'élimination des odeurs. Pas d'entretien jusqu'à 2'500 heures d'utilisation. Filtre anti graisse en métal. Puissance air 755 m³/h, volume de nettoyage env. 48 m³/h. Surface inox.

Livecookintable



«Devices»

Die Kochgeräte können nach den individuellen Bedürfnissen gewählt und ohne Werkzeug in den Tisch eingesetzt werden. Dank gut gepolsterten und mit Rollen versehenen Geräteköffern fällt auch der Transport der Geräte leicht.

Les plans de cuisson interchangeables peuvent être adaptée aux besoins individuels et s'insère facile dans le table sans outil. Le transport d'équipement est facile grâce aux valises à roulettes bien rembourré.

Grill Smart

Grill mit einer Heizzone und Fettauffangrille.
Grill inox avec rainure circulaire.

Induction Smart

Induktionskochplatte aus Glaskeramik.
Plate de cuisson induction en vitrocéramique.

Wok Smart

Induktions-Cuvette mit Wokmulde.
Cuvette induction avec renforcement.

Hot Plate Smart

Konventionelle Flächenheizung zum Regenerieren und Warmhalten.
Surface de chauffe conventionnelle pour «sous-vide».

Hot & Chill Plus

Konventionelle Flächenheizung und Kälteplatte in einem.
Surface de chauffe conventionnelle pour «sous-vide» et refroidissement

«Chefpower»

Mobiles und modulares Batteriesystem zum Betrieb von livecookintable® Frontcooking- und Buffetstationen, bestehend aus der Basisstation CHEFPOWER_core und der Zusatzbatterie CHEFPOWER_stack.

Système de batterie mobile et modulaire pour le fonctionnement des stations livecookintable® Frontcooking et Buffet, composé de la station de base CHEFPOWER_core et de la batterie supplémentaire CHEFPOWER_stack.



**«Multistation»**

Multifunktions-Regal mit Doppelrollen für hohe Belastung (Teller und Buffetware), 30 kg pro Regalboden, Oberflächen in snow white, Multiplex-Birkenholz beidseitig 1mm Laminat.

Desserte multifonction avec roues doubles pour charges importantes (assiettes et plats de buffet), 30 kg par étagère, surfaces couleur blanc neige, contreplaqué en bois de bouleau. 1 mm de stratifié des deux côtés.

**Referenzen
Références**

Art Deco Hotel Montana, Luzern
www.hotel-montana.ch

Bürgenstock Hotels AG, Obbürgen
www.buergenstock-selection.ch

Golf Restaurant gladys mit Grand Hotels Quellenhof, Bad Ragaz
www.golfclubbragaz.ch

Henris Catering & Events, Zürich
www.henris.ch



AFINOX

Fresh, Cold & Iced



buffet



Breites Programm an Unterbau- und Anstell-Möbel auf Anfrage. Vaste programme de meubles de base et d'appoint, sur demande.



LED-Beleuchtung
Eclairage à LED



Sauberkeit und Hygiene garantiert, dank gerundetem Boden und Diagonalkantung.

Propreté et hygiène garanties par le fond arrondi et diamanté.



Vertiefte Lage der Behälter für eine noch bessere Erhaltung der Produktfrische.

Logement des bacs abaissé pour une meilleure conservation des aliments frais.

TRADITION GREEN Buffet

Die eleganten Foodinseln TRADITION sind aus Edelstahl AISI 304 gefertigt und bestehen aus einem robusten Rahmen aus verchromtem Stahl auf Rollen. Die Verkleidung aus Holz passt sich allen Umgebungen problemlos an.

- Leichter Zugang zum elektrischen Teil und zur Beleuchtung, positioniert an der oberen Brücke.
- Digitale, elektronische Displays für Temperaturanzeigen.
- Kühleinheiten können aus dem technischen Raum entfernt werden, wodurch die Wartung erleichtert wird.
- Die Becken sind verschweisst und haben einen gerundeten Boden sowie eine Diagonalkantung für den Wasserabfluss sowie für perfekte Sauberkeit und Hygiene.

Les îles du goût TRADITION sont caractérisées par une grande élégance. Réalisées en acier inox AISI 304 et composées d'un châssis chromé robuste sur roulettes, elles offrent un design élégant grâce à un nouvel habillage bois qui s'adapte facilement à tous les environnements.

- Accès facile à la partie technique et à l'éclairage, situé au niveau du pont supérieur.
- Ecrans électroniques numériques pour l'affichage des températures.
- Unités frigorifiques extractibles du compartiment technique pour faciliter l'entretien.
- Les cuves sont soudées avec un fond arrondi et diamanté pour faciliter l'évacuation de l'eau et pour garantir une hygiène et une propreté parfaites.

buffet

Wenge
Wengé

Hemlock

**TRADITION PLUS GREEN Buffet**

Temp. +4 – +8° C

Kaltbuffet mit statischer Kühlung, Tiefe der Behälter bis max. 200 mm, Brückenaufbau mit elektrischer Haube und LED-Beleuchtung, Zubehör auf Anfrage erhältlich
Farben: Hemlock, Wengé (Bild) oder RAL-Farben

Buffet réfrigéré statique, profondeur maximale des bacs 200 mm, couvercle mobile électrique et éclairage LED, accessoires disponibles (sur demande)
Couleurs: Hemlock, Wéngé (photo) et couleurs RAL

GN 3/1 - 1169 x 650 x H 1488 mm

400-10310	Hemlock			6234.00
400-10320	Wengé/Wéngé			6234.00
400-10330	RAL			6870.00

GN 4/1 - 1494 x 650 x H 1488 mm

400-10410	Hemlock			6468.20
400-10420	Wengé/Wéngé			6468.20
400-10430	RAL			7410.00

GN 6/1 - 2144 x 650 x H 1488 mm

400-10610	Hemlock			7410.00
400-10620	Wengé/Wéngé			7410.00
400-10630	RAL			8223.30

Auch mit Schleierkühlung und Unterbau für Geschirr erhältlich.
Disponible aussi avec voile de refroidissement et structure pour vaisselle.

Lieferung Bordsteinkante, Installationspauschale auf Anfrage.
Livraison franco usine, forfait d'installation sur demande.



Auf Anfrage:
Die Buffets sind auch in RAL-Farben lieferbar.
Sur demande:
Les buffets sont livrables en couleur RAL.

Wenge
Wengé

Hemlock



Auf Anfrage:
Die Buffets sind auch in RAL-Farben lieferbar.
Sur demande:
Les buffets sont livrables en couleur RAL.

TRADITION PLUS RED Buffet

Temp. +30 – +90° C

Buffet für heiße Speisen mit Becken für Warmhalten im Wasserbad, Tiefe der Behälter bis max. 200 mm, Brückenaufbau mit fester Haube und Halogenheizlampen, Zubehör auf Anfrage erhältlich
Farben: Wengé (Bild), Kirschholz oder RAL-Farben

Buffet pour aliments chaud avec bassin pour tenir au chaud au bain-marie, profondeur maximale des bacs 200 mm, structure avec capot et lampes halogènes, accessoires disponibles (sur demande)

Couleurs: Wengé (photo), cerisier clair et couleurs RAL

GN 3/1 - 1169 x 650 x H 1488 mm

400-20310	Hemlock		6339.85
400-20320	Wengé/Wengé		6339.85
400-20330	RAL		6985.00

GN 4/1 - 1494 x 650 x H 1488 mm

400-20410	Hemlock		6985.00
400-20420	Wengé/Wengé		6985.00
400-20430	RAL		7598.80

GN 6/1 - 2144 x 650 x H 1488 mm

400-20610	Hemlock		8698.80
400-20620	Wengé/Wengé		8698.80
400-20630	RAL		9410.00

Lieferung Bordsteinkante, Installationspauschale auf Anfrage.
Livraison franco usine, forfait d'installation sur demande.



Tablettrutsche Inoxpaneel Plateau acier inoxydable

GN 3/1

400-10390	1167 x 220 mm		351.70
-----------	---------------	--	--------

GN 4/1

400-10490	1492 x 220 mm		423.50
-----------	---------------	--	--------

GN 6/1

400-10690	2124 x 220 mm		529.20
-----------	---------------	--	--------

Unterbau- und Anstell-Möbel auf Anfrage.
Meubles de base et d'appoint, sur demande.



Farbbeispiele
Exemples de couleur

Tellerspender, Speiseausgabewagen und Co – bei uns passend zu Ihrem Interieur-Design!

Distributeurs de vaisselle, Distributeurs de repas et plus – chez nous adaptables à votre design d'intérieur!

Möchten Sie den Tellerspender im Gästebereich beim Buffet platzieren und die Verkleidung passend zum Buffet und Interieur haben? Gehört Inox für Sie nicht in den Frontbereich? Kein Problem, wir haben bestimmt die passende Farbe und Struktur für Sie! Bitte kontaktieren Sie uns. Wir beraten Sie gerne.

Le distributeur de vaisselle dans le secteur des clients à côté du buffet? Revêtement adaptables au buffet? L'inox au front chez les clients n'est pas en cause. Nous avons sûrement le couleur et la structure désirés! N'hésitez pas à nous contacter, nous vous conseillons avec un grand plaisir!



tablets



CAMBRO «Camtray®»
Fiberglas mit glatter Oberfläche, niedriges Profil
Fibre de verre avec surface lisse, profil bas

Extrem robust. Praktisch unzerstörbar. Geeignet für mehrmaliges tägliches gewerbliches Spülen auch über einen mehrjährigen Zeitraum. Grosse Farbauswahl.
Extrêmement robuste. Pratiquement indestructible. Adapté à plusieurs passages quotidiens au lave-vaisselle industriel, pendant plusieurs années. Large choix de couleurs.

662632xxx	GN 1/2 - 32,5 x 26,5 cm			32.90
663343xxx	Self Service - 43 x 33 cm			39.80
663253xxx	GN 1/1 - 53,0 x 32,5 cm			46.85
663753xxx	EN 1/1 - 53,0 x 37,0 cm			49.35

Erhältliche Farben | Couleurs livrables:



tablets



GN 1/2 32,5 x 26,5 cm	Self Service 43 x 33 cm	GN 1/1 53,0 x 32,5 cm	EN 1/1 53,0 x 37,0 cm
--------------------------	----------------------------	--------------------------	--------------------------

CAMBRO «Camtray®»
Fiberglas mit glatter Oberfläche, niedriges Profil
Fibre de verre avec surface lisse, profil bas

Extrem robust. Praktisch unzerstörbar. Geeignet für mehrmaliges tägliches gewerbliches Spülen auch über einen mehrjährigen Zeitraum. Grosse Farbauswahl.
Extrêmement robuste. Pratiquement indestructible. Adapté à plusieurs passages quotidiens au lave-vaisselle industriel, pendant plusieurs années. Large choix de couleurs.

662632110	GN 1/2 - 32,5 x 26,5 cm			32.90
663343110	Self Service - 43 x 33 cm			39.80
663253110	GN 1/1 - 53,0 x 32,5 cm			46.85
663753110	EN 1/1 - 53,0 x 37,0 cm			49.35

Achtung: Durch häufiges waschen (mehrmals täglich) können Spuren von Chemierückständen ersichtlich werden.
Attention: un lavage très fréquent (plusieurs fois par jour) peut révéler des traces de résidus chimiques.



GN 1/2 32,5 x 26,5 cm	GN 1/1 53,0 x 32,5 cm
--------------------------	--------------------------

CAMBRO «VT»
Gastronom-Tablett, niedriges Profil
Plateau gastronomique, profil bas

Fiberglas-verstärktes Polyester mit glatter Oberfläche.
Polyester renforcé de fibre de verrea, surface lisse.

VT2632Axxx	GN 1/2 - 32,5 x 26,5 cm			21.15
VT3253Axxx	GN 1/1 - 53,0 x 32,5 cm			30.55

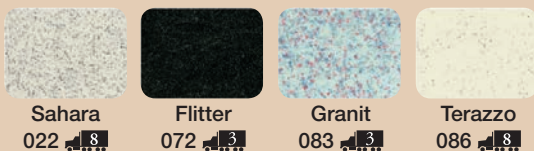

Weitere Farben mit Minimumquantität 120 Stück auf Anfrage.
Autres couleurs avec une quantité minimale de 120 pièces sur demande.



EN 1/1 53,0 x 37,0 cm

CAMBRO «VT»
Euronorm-Tablett, niedriges Profil
Plateau euronorme, profil bas

Fiberglas-verstärktes Polyester mit glatter Oberfläche.
Polyester renforcé de fibre de verrea, surface lisse.

VT3753Axxx	EN 1/1 - 53,0 x 32,5 cm			37.60
------------	-------------------------	--	--	-------

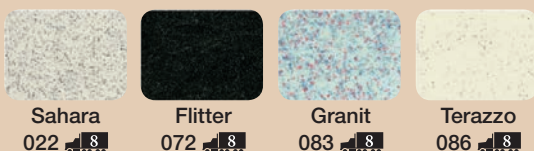

Weitere Farben mit Minimumquantität 120 Stück auf Anfrage.
Autres couleurs avec une quantité minimale de 120 pièces sur demande.



GN 1/2
32,5 x 26,5 cm

GN 1/1
53,0 x 32,5 cm

CAMBRO «GP»
Gastronorm-Tablett, abgeflachte Kanten
Plateau gastronorme, rebord plat

Fiberglas-verstärktes Polyester mit glatter Oberfläche.
Polyester renforcé de fibre de verrea, surface lisse.

GP1070Axxx	GN 1/2 - 32,5 x 26,5 cm			21.15
GP4002Axxx	GN 1/1 - 53,0 x 32,5 cm			29.35



Lichtgrau
027

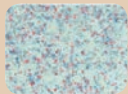

Granit
083

Weitere Farben mit Minimumquantität 120 Stück auf Anfrage.
Autres couleurs avec une quantité minimale de 120 pièces sur demande.



EN 1/1
53,0 x 37,0 cm

CAMBRO «GP»
Euronorm-Tablett, abgeflachte Kanten
Plateau euronorme, rebord plat

Fiberglas-verstärktes Polyester mit glatter Oberfläche.
Polyester renforcé de fibre de verrea, surface lisse.

GP3980A086	EN 1/1 - 53,0 x 37,0 cm			31.70
------------	-------------------------	--	--	-------



Terazzo
086

Weitere Farben mit Minimumquantität 120 Stück auf Anfrage.
Autres couleurs avec une quantité minimale de 120 pièces sur demande.



CAMBRO «Microban®»
Antibakterielle Camquard Versa Tablett
Plateaux antibactériens Camquard Versa

Hochleistungs-Polyestertablett für den besonders intensiven Einsatz. Temperaturresistent von -40°C bis 140°C. Der integrierte antibakterielle Microban® Schutz zerstört Bakterien auch zwischen den Reinigungsvorgängen. Er kann nicht abgewaschen werden und bleibt während der gesamten Lebensdauer des Tablett intakt. Verstärkte Polyester-Ecken sorgen für einen verbesserten Schutz vor Stößen an den Ecken und Kanten. Plateau de polyester de haute performance pour une utilisation la plus intensive. Résistant à des températures de -40°C à 140°C. La haute protection du Microban® antibactérienne détruit les bactéries même entre les processus de nettoyage. Elle ne peut pas être délavée et reste intacte tout au long de la vie du plateau. Les coins renforcés en polyester offrent une meilleure protection contre les chocs vers les coins et les bords.

8323.02510	GN 1/1 - 53,0 x 32,5 cm			38.80
8323.02520	GN 1/2 - 32,5 x 26,5 cm			24.90
8323.02530	EN 1/1 - 53,0 x 37,0 cm			42.30
8323.02540	EN 1/2 - 37,0 x 26,5 cm			26.10

tablets

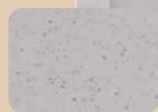

10
design grau

			
GN 1/1 53 x 32,5 cm	EN 1/1 53 x 37 cm	Self Service 46 x 34,4 cm	Self Service 43 x 33 cm









«Poly Classic»

Glasfaserpolyester Tablett

Plateau fibres de verre polyester

Polyesterharz mit 27% Glasfaseranteil, in der Masse gefärbt, Formstabil, für industrielle Geschirrspülmaschinen geeignet, verstärkte Ränder und Ecken aus massivem Polyester zum Schutz gegen Abbrechen oder Absplittern, Stapelnocken für gute Belüftung und perfekte Stapel, Gleitrinnen gegen Verschmutzung an der Unterseite, 5 Jahre Garantie gegen Bruch

Résine de polyester avec des fibres de verre de 27%, colorés dans la masse, indéformable, convient aux lave-vaisselles industriels, bords et coins renforcés de polyester solide pour la protection contre l'écaillage ou le décrochage, segments d'empilages pour une bonne ventilation et un empilage parfait, rigoles coulissantes contre la saleté au fond, 5 ans de garantie contre brisure

8330.25010	GN 1/1 - 53,0 x 32,5 cm			34.05
8330.25110	EN 1/1 - 53,0 x 37,0 cm			35.15
8330.25410	Self Service - 46,0 x 34,4 cm			32.90
8330.25510	Self Service - 43,0 x 33,0 cm			30.55

					
GN 1/1 53 x 32,5 cm	EN 1/1 53 x 37 cm	GN 1/2 32,5 x 26,5 cm	EN 1/2 37 x 26,5 cm	Self Service 46 x 34,4 cm	Self Service 43 x 33 cm













«Poly Smart»

Glasfaserpolyester Tablett

Plateau fibres de verre polyester

Robustes und zugleich preisgünstiges Tablett mit hoher Spülmaschinenbeständigkeit, 3 Jahre Garantie gegen Bruch.

Plateau solide à un coût très abordable avec haute résistance au lave-vaisselle, 3 ans de garantie contre brisure

8330.40044	GN 1/1 - 53,0 x 32,5 cm			28.20
8330.41044	EN 1/1 - 53,0 x 37,0 cm			29.35
8330.42044	GN 1/2 - 32,5 x 26,5 cm			21.15
8330.43044	EN 1/2 - 37,0 x 26,5 cm			23.50
8330.44044	Self Service - 46,0 x 34,4 cm			26.10
8330.45044	Self Service - 43,0 x 33,0 cm			24.90



44
massiv grau









«Gastrolicious»

Polyester Tablett

Plateau polyester

Robustes Polyestertablett in modernem Design mit einer matten, strukturierten Oberfläche. 5 Jahre Garantie gegen Bruch.

Plateau en polyester robuste au design moderne avec une surface mate et structurée. Garantie de 5 ans contre la casse.

8330.45050	GN 1/1 - 53,0 x 32,5 cm			41.15
8330.45055	GN 1/2 - 32,5 x 26,5 cm			28.20
8330.45056	Self Service - 46,0 x 34,4 cm			42.30
8330.45057	Self Service - 43,0 x 33,0 cm			40.65



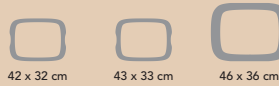

42 x 32 cm 43 x 33 cm 46 x 36 cm

«Earth Tray Wave»

Ökologisches Kantinen-Tablett
Plateau pour cantines écologique

Earth Tray ist das erste Tablett, das zu 90% aus nachwachsenden Rohstoffen besteht. Dieses Tablett wird aus 70% FSC-Holz und 20% Bioabfall-Harz gefertigt. Durch die ergonomisch geformten Ränder liegt dieses Tablett nicht nur angenehm in der Hand, sondern hat auch eine einzigartige und stilvolle Ausstrahlung. Bedingt Spülmaschinenfest.

Le Earth Tray est le premier plateau de haute qualité composé de 90 % de matériel renouvelable. Ce plateau est fabriqué avec 70% de bois FSC et de 20% de résine de bio déchets. Ce plateau a été conçu dans le plus grand souci du confort de l'utilisateur. Grâce à ses bords ergonomiques, il tient bien en main mais possède aussi un look unique et élégant. Résistant aux lave-vaisselles.



grey wood

8330.14078	42 x 32 cm			29.35
8330.15078	43 x 33 cm			30.55
8330.16078	46 x 36 cm			32.90

light wood | dark wood | warm wood | beton

8330.14XXX	42 x 32 cm			31.70
8330.15XXX	43 x 33 cm			32.90
8330.16XXX	46 x 36 cm			34.05

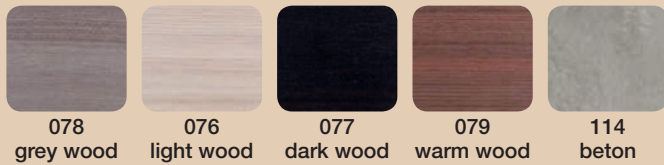

078 grey wood 076 light wood 077 dark wood 079 warm wood 114 beton



GN 1/1 53 x 32,5 cm Self Service 46,5 x 35,5 cm Self Service 43 x 33 cm

«Dura»

Tablett für intensive Nutzung
Plateau pour une utilisation intensive

Das Dura-Tablett strahlt reine Natur aus. Aber täuschen Sie sich nicht: dieses Tablett ist vollständig aus Polyester und dadurch bärenstark. Dank seiner matten Oberfläche werden Besteck, Teller und Gläser zudem nicht rutschen. Tolles Design und gleichzeitig ergonomisch optimal: Dura bietet alles. Für industrielle Geschirrspüler geeignet.

Le plateau Dura pourrait se fondre dans la nature. Mais ne vous y méprenez pas: celui-ci est entièrement en polyester et donc extrêmement résistant. Sa surface mate empêche les assiettes, les verres et les couverts de glisser. Design esthétique et ergonomie optimale : Dura combine tous les avantages. Adapté aux lave-vaisselle industriels.



8330.61XXX	GN 1/1 - 53,0 x 32,5 cm			56.40
8330.62XXX	Self Service - 46,5 x 35,5 cm			50.55
8330.63XXX	Self Service - 43 x 33 cm			46.95



110 vintage 111 oak 113 white marble 114 beton

tablets

CAMBRO «Madeira»
 Tablets mit texturierter Oberfläche
 Plateaux avec une surface texturée

Laminiertes Schichtstofftablett mit texturierter Holzoberfläche oben und unten, Spülmaschinenfest bis 1 mal spülen pro Tag, geeignet für eine moderate Verwendung
 Plateau en stratifié avec une surface en bois texturée au-dessus et en dessous, résistant au lave-vaisselle (jusqu'à 1 lavage par jour), adapté pour une utilisation modérée

8323.01XXX	Self Service - 43 x 33 cm			17.40
8323.02XXX	Self Service - 46 x 36 cm			18.80
8323.03XXX	Self Service - 53 x 37 cm			22.30

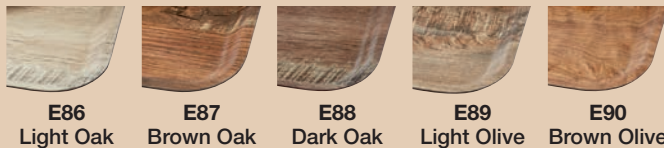

E86 Light Oak **E87** Brown Oak **E88** Dark Oak **E89** Light Olive **E90** Brown Olive

CAMBRO «Century»
 Tablets mit Holzdekor
 Plateaux imitation bois

Die Century-Tablets mit Holzdekor kombinieren die Holzoptik mit langer Haltbarkeit und sind für gut besuchte Selbstbedienungsrestaurants geeignet. Aus Hochleistungspolyester gefertigt und für die intensive Nutzung geeignet. Kratz-, Flecken- und Chemikalienbeständig, Bruchstabil (bei sachgemäßer Anwendung). Temperaturbereich von -40° bis 90°C. Spülmaschinenfest – die Tablets können beliebig oft gespült werden.

Associant l'aspect authentique de la fibre de bois à une grande durabilité, le plateau imitation bois Century est idéal pour les cafétérias à forte fréquentation. Fabriqué en polyester haute performance pour un usage intensif. Incassable, résistant aux rayures, aux tâches et aux produits chimiques. Résiste à des températures comprises entre -40° et 90°C. Lavable en lave-vaisselle. A laver aussi souvent que nécessaire.



8323.05XXX	Self Service - 43 x 33 cm			37.60
8323.06XXX	Self Service - 45,7 x 35,5 cm			41.15
8323.07XXX	GN 1/1 - 53,0 x 32,5 cm			43.50

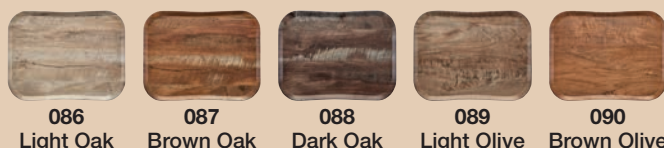

086 Light Oak **087** Brown Oak **088** Dark Oak **089** Light Olive **090** Brown Olive



«Black Line»
Thermoplast Tablett
Plateaux thermoplastique

Ein robustes und rutschsicheres Tablett im eleganten Look mit strukturierter Oberfläche. Robust und kratzfest, geruchlose rutschfeste Beschichtung. Nicht für dauernden gewerblichen Spülmaschineneinsatz geeignet.

Un plateau robuste et antidérapante en look élégant avec surface structurée. Robuste et résistant aux rayures, couche antidérapante odeur neutre. Ne convient pas à un lavage en machine industrielle sur le long terme.

8330.30010	Self Service Mini - 35,0 x 26,0 cm			38.20
8330.30020	Self Service - 42,0 x 30,0 cm			46.90
8330.30030	Self Service - 49,0 x 34,0 cm			58.80
8330.30040	Service Master - 63,0 x 39,0 cm			89.35
8330.30050	Round Service - 31,0 cm			34.65
8330.30060	Round Service - 38,0 cm			44.65



10
Service Mini



20
Service



30
Service



40
Service Master



50
Round Service



60
Round Service



CAMBRO «Camtread»
Serviertablett rund, rutschfest
Plateaux à service rond, anti-dérapant

Fiberglas mit rutschfester Gummioberfläche, spülmaschinenfest
Plateau avec revêtement antidérapant, garantie lave-vaisselle

8323.01110	Ø 35,5 cm	Schwarz/noir			42.30
8323.02110	Ø 40,5 cm	Schwarz/noir			54.05
8323.02111	Ø 45 cm	Schwarz/noir			61.15



CAMBRO «Camtread»
Serviertablett oval, rutschfest
Plateaux à service oval, anti-dérapant

Fiberglas mit rutschfester Gummioberfläche, spülmaschinenfest
Plateau avec revêtement antidérapant, garantie lave-vaisselle

8323.02112	49 x 59 cm	Schwarz/noir			112.80
8323.02113	56 x 68,5 cm	Schwarz/noir			117.25
8323.02114	73,5 x 60 cm	Schwarz/noir			148.20

tablets

Kantinen-Tablett granitgrau
Plateau pour cantines granite

aus glasfaserverstärktem Polyester, schlagfest und bruchstabil, spülmaschinenfest, temperaturresistent von -50°C bis +140°C, säure-, laugen- und UV-beständig, im Stapel belüftbar

En polyester renforcé de fibre de verre, résistant au choc et cassure, convient au lave-vaisselle, résistant aux températures de -50°C à + 140°C, résistant à l'acide, solution alcaline et UV, s'aèrent en étant empilés

8005.03822 46 x 36 cm



27.75

Tablettabräumwagen für Kantinentablets
Chariot à débarrasser pour plateaux de cantines

Der Wagen ist für normale Kantinentablets, 430x330 mm, mit Längseinschub konzipiert. Erhältlich in zwei Varianten, 1-teilig oder 2-teilig mit Kapazität für 9 bzw. 18 Tablets. Der Wagen ist sehr hochwertig und komplett aus Chrom-Nickelstahl gefertigt. Er wird standardmässig mit lichtgrauen Argolite-Platten ausgestattet (Abbildung anthrazit). Weitere Farben auf Anfrage erhältlich. Für den Wagen gibt es einen speziellen Federrahmen für unebene Böden, der Erschütterungen vorbeugt.

Le chariot est conçu pour des plateaux standards 430x330 mm à déposer dans le sens de la longueur. Il est disponible en deux variantes: modèle simple pour 9 plateaux ou modèle double pour 18 plateaux. Le chariot est entièrement fabriqué en acier chrome-nickel avec parois en Argolite gris clair (illustration en anthracite). D'autres couleurs sont disponibles sur demande. Spécialement pour les sols irréguliers, il peut être doté d'amortisseurs afin d'assurer un déplacement tout en douceur.

Tablettgrößen/Grandeurs des plateaux:

1x 430x330 mm längs/longueur

2x 210x320 mm quer/largeur

1x GN1/2 265x325 mm quer/largeur

1-teilig / simple

T0131000 44,2 x 52,7 cm x H 165 cm



2351.50

T0131002 Federrahmen/amourtisseurs



635.05

2-teilig / double

T0131001 79,7 x 52,7 cm x H 165 cm



3057.40

T0131003 Federrahmen/amourtisseurs



740.00





GN-Tablett
Plateau GN





aus glasfaserverstärktem Polyesterharz, granitgrau, schlagfest und bruchstabil, spülmaschinenfest, temperaturresistent von -50°C bis +140°C, säure-, laugen- und UV-beständig, im Stapel belüftbar
En polyester renforcé de fibre de verre, couleur granite, résistant au choc et cassure, convient au lave-vaisselle, résistant aux températures de -50°C à + 140°C, résistant à l'acide, solution alcaline et UV, s'aèrent en étant empilés

8005.50167 GN 1/1 - 53 x 32,5 cm   26.95



KAFFEEHAUS
Serviertablett rechteckig
Plateau de service rectangulaire









Inox matt poliert
Inox poli mat

8005.00066 21,5 x 13 cm x H 1,5 cm   11.70
8005.00065 23 x 23 cm x H 1,5 cm   16.40



KAFFEEHAUS
Serviertablett oval
Plateau de service ovale

Inox matt poliert
Inox poli mat

8582.30111 19,0 x 15,0 cm   8.20
8582.30123 23,0 x 17,5 cm   10.55
8582.30112 26,5 x 19,0 cm   11.70
8582.30113 29,0 x 22,0 cm   12.15

tablets



DEGRENNE
PARIS

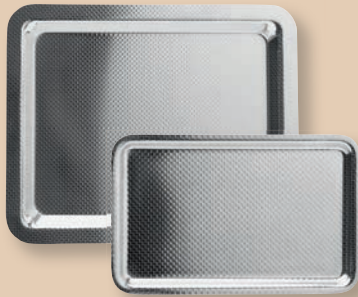







NEWPORT CUBIQUE
Tablett rechteckig
Plateau rectangulaire

Inox

19211888200	32,5 x 26,5 cm			76.35
19211889200	22,0 x 13,0 cm			38.60

VINTAGE
Tablett
Plateau





Edelstahl
Inox

8582.30130	26 x 13,5 x H 1,5 cm			11.70
8582.30131	34 x 18 cm x H 1,5 cm			19.95
8582.30132	38 x 26,5 x H 1,5 cm			32.30

AdHoc®







SERVE
Serviertablett
Plateau de service

161291100	60 x 31 cm x H 5 cm			46.80
161398100	50 x 30 cm x H 5 cm			49.80

AdHoc®







SERVE SQUARE
Serviertablett
Plateau de service

161304100	40 x 40 cm x H 5 cm			46.80
161399100	25 x 25 cm x H 6 cm			34.05







AdHoc®



SERVE SLIM
Serviertablett
Plateau de service





161305100	60 x 15,5 cm x H 5 cm			38.75
161400100	50 x 13 cm x H 5 cm			34.05

point
virgule
BAMBOO
 Tablett
 Plat à servir





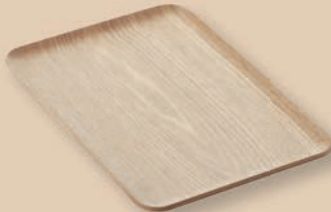

880-53400	21,0 x 14,5 x H 1,9 cm			19.95
880-53500	28,0 x 19,0 x H 1,9 cm			28.50
880-53600	35,0 x 24,0 x H 1,9 cm			43.50

point
virgule
LIVING
 Serviertablett
 Plateau à servir





weiss | blanc

880-55400	22,5 x 12,5 cm x H 1,5 cm			13.40
880-55500	33,0 x 23,0 cm x H 1,5 cm			25.15



point
virgule
LIVING
 Serviertablett
 Plateau à servir

880-55000	22,5 x 12,5 cm x H 1,5 cm			11.50
880-55100	33,0 x 23,0 cm x H 1,5 cm			22.50
880-55200	39,0 x 27,0 cm x H 1,5 cm			29.80

point
virgule
LIVING
 Serviertablett mit Griffen
 Plateau avec poignées

880-51800	44,5 x 33,5 cm x H 4,5 cm			34.50
880-51900	55,0 x 40,0 cm x H 5,0 cm			51.80

point
virgule
LIVING
 Bett-Tablett
 Plateau de lit

880-52000	56 x 31 cm x H 22 cm			76.35
-----------	----------------------	---	---	-------

chilewich®



tablemats & runners

Sandy Chilewich entdeckte im Jahre 1997 das Material Vinyl für die Herstellung von Tischsets. Seither erlebte diese Sparte der Tischdekoration eine Revolution, sei es in privaten Haushalten oder in Restaurants.

Die Artikel werden in New York entworfen und vollständig in den USA hergestellt. Chilewich vereint Design, Funktionalität und Qualität. Mit jeder Frühlings- und Herbstkollektion kommen neue Farben und Muster auf den Markt. Diese Innovationen ermöglichen Chilewich, unumstrittener Branchenleader zu bleiben und sich problemlos gegen die stetig wachsende Konkurrenz durchzusetzen.

Chilewich - schön anzuschauen.
Und auch sonst überzeugend.
Das Original gibt's nur bei Berndorf!



Sandy Chilewich découvrit en 1997 la matière Vinyl pour la fabrication de sets de table. Depuis, la décoration de la table et particulièrement ce secteur a vécu dans le ménage et la restauration une véritable révolution.

Ces articles ont été conçus à New York et sont entièrement fabriqués aux USA. Chilewich unit dessin, fonctionnalité et qualité. Avec chaque collection printanière et d'automne, de nouvelles couleurs et nouveaux dessins apparaissent sur le marché. Ces nouveautés permettent à Chilewich de rester leader de la branche et de s'imposer contre une concurrence croissante.

Chilewich - beau à voir.
Mais aussi convaincant.
L'original seulement de chez Berndorf!

WAS FÜR CHILEWICH SPRICHT:

- attraktive Optik
- pflegeleicht
- widerstandsfähig
- riesige Auswahl an Formen und Farben
- passt auf jeden Tisch
- auch Sonderanfertigungen möglich



Quelques atouts en faveur de Chilewich:

- optique attractive
- facile à entretenir
- résistant
- énorme choix des formes et couleurs
- va sur chaque table
- fabrication spéciale sur demande

PFLEGEHINWEISE FÜR TISCHSETS UND TISCHLÄUFER AUS VINYL

Fleckenentfernung

Alle Produkte aus Vinyl, alle Farben:
Abwischen mit feuchtem Lappen, unter fließendem Wasser abspülen, einlegen im Wasser, im Bedarfsfall unter Zuhilfenahme von handelsüblichem Spülmittel.

Bei Flecken auf hellen Tischsets:
Bleichmittel (Javel) im Wasser auflösen (im Verhältnis 1:3), abbürsten und gut abspülen.

Waschen im Geschirrspüler bitte unterlassen, da die Hitze das Gewebe auflösen kann. Die meisten Maschinen sind nicht fein genug eingestellt, deshalb ist diese Reinigungsart nicht empfehlenswert.

Falten und Knickstellen

Zerknitterte oder geknickte Stellen kurz mit Wärme (kurz föhnen) behandeln und danach flach pressen (Buch, Serviertablett etc.) oder mit dem Dampfbügeleisen unter Zuhilfenahme eines Abdecktuches. Achtung: Vinyl ist ein Kunststoff und schmilzt unter Hitze. Bügeleisen nicht zu lange an der gleichen Stelle belassen!

RECOMMANDATIONS D'ENTRETIEN POUR LES SETS ET LE CHEMINS DE TABLE EN VINYL

Détacher

Tous les produits en Vinyl, toutes les couleurs:
Essuyer avec un chiffon humide, rincer sous l'eau courante, plonger dans l'eau. Si nécessaire, ajouter un détergent habituel.

Pour des tâches sur sets clairs:
Liquide blanchissant (javel) diluer dans de l'eau (rapport 1:3), brosser et bien rincer.

Ne pas utiliser la machine à laver pour nettoyer, la chaleur peut déstructurer le tissu. La plus part des machines ne sont pas assez fines au réglage, c'est pourquoi ce genre de nettoyage n'est pas recommandable.

Plis et endroits froissés

Des endroits froissés ou pliés traités rapidement à chaud (séchoir) et ensuite aplanir avec un poids (livre, plateaux, etc.) ou à l'aide d'un fer à repasser protéger d'une couverture. Attention: Vinyl est en matière synthétique et fond sous la chaleur. Ne pas laisser le fer à repasser trop longtemps au même endroit!

tablemats & runners

ERHÄLTICHE FARBEN
COULEURS LIVRABLES

BASKETWEAVE	rectangle 36x48cm	hospitality 30x41cm	round Ø 38cm			runner 36x183cm
Bark	●	●	●			●
Black	●	●	●			●
Carbon	●	●	●			●
Denim	●	●	●			●
Earth	●	●	●			●
Gilded	●	●	●			●
Khaki	●	●	●			●
Latte	●	●	●			●
Natural	●	●	●			●
Oyster	●	●	●			●
Pine	●	●	●			●
Shadow	●	●	●			●
White/Silver	●	●	●			●
MINI BASKETWEAVE	rectangle 36x48cm	hospitality 30x41cm	round Ø 38cm	oval 36x49cm	hospitality oval 30x41cm	runner 36x183cm
Black	●	●	●	●	●	●
Blush	●	●	●	●		●
Chambray	●	●	●	●	●	●
Cinnamon	●	●	●	●		●
Clay	●	●	●	●		●
Confetti	●	●	●	●	●	●
Cool Grey	●	●	●	●		●
Dark Walnut	●	●	●	●	●	●
Dill	●	●	●	●	●	●
Espresso	●	●	●	●	●	●
Gravel	●	●	●	●	●	●
Indigo	●	●	●	●		●
Ivy	●	●	●	●		●
Light Grey	●	●	●	●	●	●
Linen	●	●	●	●	●	●
Mist	●	●	●	●		●
Parchment	●	●	●	●		●
Sky	●	●	●	●		●
Soapstone	●	●	●	●	●	●
Turquoise	●	●	●	●	●	●
BAMBOO	rectangle 36x48cm	hospitality 30x41cm	round Ø 38cm	oval 36x49cm		runner 36x183cm
Camel	●	●	●	●		●
Chalk	●	●	●	●		●
Chino	●	●	●	●		●
Coconut	●	●	●	●		●
Cranberry	●	●	●	●		●
Dune	●	●	●	●		●
Fog	●	●	●	●		●
Grey Flannel	●	●	●	●		●
Lapis	●	●	●	●		●
Moonlight	●	●	●	●		●
Oat	●	●	●	●		●
Rain	●	●	●	●		●
Seaglass	●	●	●	●		●
Smoke	●	●	●	●		●
Spring Green	●	●	●	●		●

THATCH	rectangle 36x48cm	hospitality 30x41cm	oval 36x49cm
Dove	●	●	●
Pebble	●	●	●
Pewter	●	●	●
Rain	●	●	●
Umber	●	●	●
OMBRÉ	rectangle 36x48cm		runner 36x183cm
Gold	●		●
Ink	●		●
Jade	●		●
Natural	●		●
Ruby	●		●
Silver	●		●
Sunrise	●		●
RIB WEAVE	rectangle 36x48cm		runner 36x183cm
Birch	●		●
Butterscotch	●		●
Indigo	●		●
Pearl	●		●
Spice	●		●
Tigereye	●		●
MOSAIC	rectangle 36x48cm	hospitality oval 30x41cm	runner 36x183cm
Blue	●	●	●
Grey	●	●	●
Pink Lemonade	●	●	●
White/Black	●	●	●
WAVE	rectangle 36x48cm		runner 36x183cm
Blue	●		●
Grey	●		●

Farbmuster und Preise auf den folgenden Seiten
Schéma de couleur et liste de prix sur les pages suivantes



ERHÄLTICHE GRÖSSEN GRANDEURS LIVRABLES

Rechteckige Sets
Sets rectangulaires
36 x 48 cm

Gastro Sets
Sets gastronomie
30 x 41 cm

Runde Sets
Sets ronds
Ø 38 cm

Ovale Sets
Sets ovales
46x49 cm

Gastro Sets oval
Sets gastronomie ovale
30 x 41 cm

Läufer
Chemins de table
36 x 183 cm

Spezialanfertigungen: bei den Tischsets braucht es Minimummengen von 50 Stück, bei den Läufern 20 Stück. Die Lieferfrist beträgt 8 Wochen.
Toleranzen: Abweichungen von +/- 1 bis 1.5 cm liegen im Toleranzbereich. Die Sets werden wie Textilien gewoben und auf dem langen Kettbaum können Spannungen entstehen. Dadurch können nach dem Zuschneiden leichte Massabweichungen entstehen.

Fabrication spéciale à partir de 50 sets au minimum, pour les traverses 20 pièces. Délai de livraison env. 8 semaines.
Tolérances: Marginalité de +/- 1 à 1,5 cm de tolérance. Les sets sont tissés comme les textiles et sur le long ensouple des tensions sont possibles. Ceci peut provoquer de légers écarts de dimensions lors des découpes.

tablemats & runners

block
buster

BASKETWEAVE

Tischsets aus gewobenem Vinyl
Sets de table en vinyle tissé

4213 xx 300	36 x 48 cm	2		25.75
4224 xx 300	30 x 41 cm	8	24	23.35
4215 xx 300	Ø 38 cm rund/rond	2		23.35

Tischläufer aus gewobenem Vinyl
Chemins de table en vinyle tissé

4211 xx 300	36 x 183 cm	8		99.80
-------------	-------------	---	--	-------

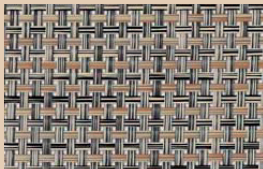
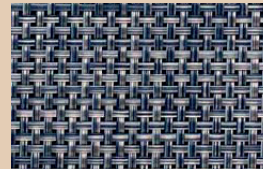
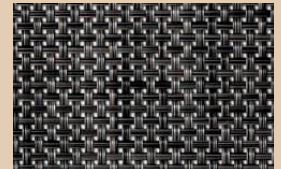
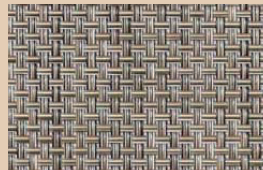
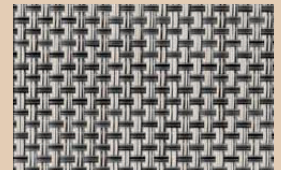
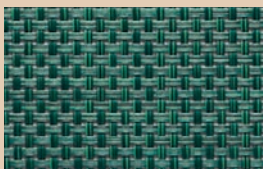
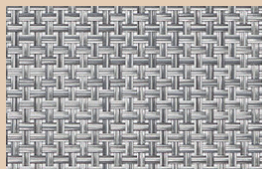
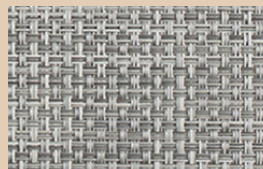
bark
82black
86carbon
96denim
76earth
70gilded
52khaki
08latte
77natural
55oyster
95pine
53shadow
50white/silver
06



MINI BASKETWEAVE

Tischsets aus gewobenem Vinyl
Sets de table en vinyle tissé

4213 xx 300	36 x 48 cm				25.75
4224 xx 300	30 x 41 cm				23.35
4215 xx 300	Ø 38 cm	rund/rond			23.35
4206 xx 300	36 x 49 cm	oval/ovale			28.15
4202 xx 300	30 x 41 cm	oval/ovale			23.35

Tischläufer aus gewobenem Vinyl
Chemins de table en vinyle tissé

4211 xx 300	36 x 183 cm				99.80
-------------	-------------	--	--	--	-------



black
67

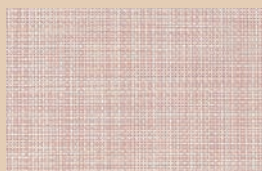

blush
33

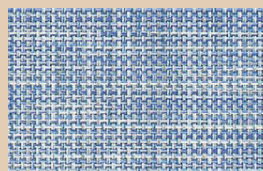

chambray
20

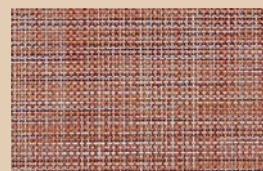

cinnamon
44

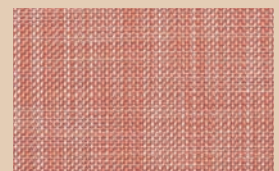

clay
42

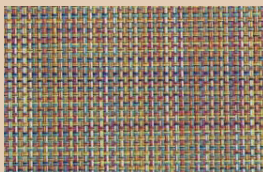

confetti
99

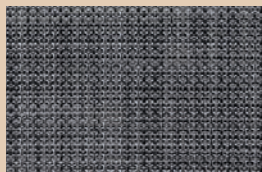

cool grey
68



dark walnut
36

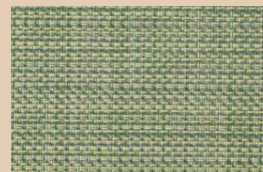

dill
10



espresso
37

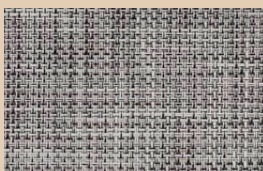

gravel
19

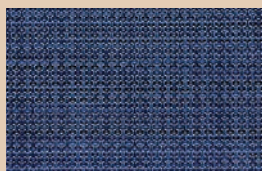

indigo
40



ivy
43



light grey
39

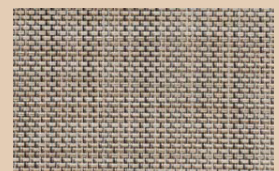

linen
38

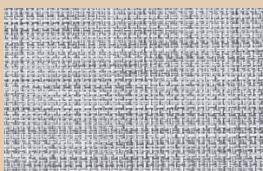

mist
34



parchment
11

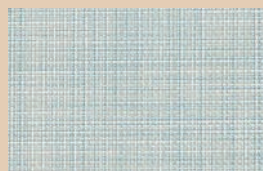

sky
94



soapstone
66

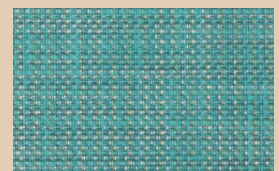

turquoise
13

tablemats & runners

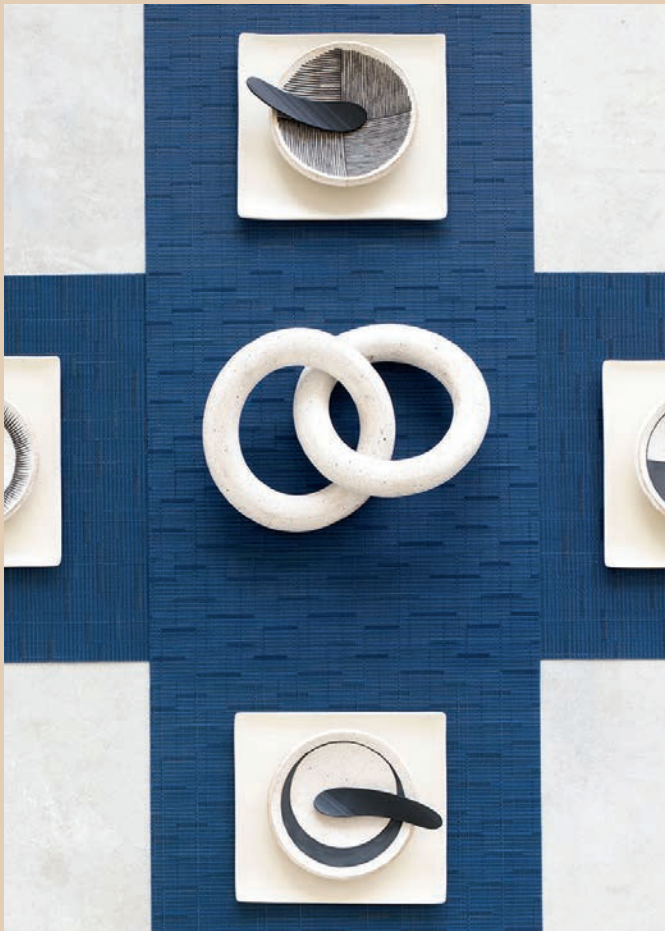
block
buster

BAMBOO

Tischsets aus gewobenem Vinyl
Sets de table en vinyle tissé

4216 xx 300	36 x 48 cm			25.75
4225 xx 300	30 x 41 cm			23.35
4228 xx 300	Ø 38 cm			23.35
4240 xx 300	36 x 49 cm			28.15

Tischläufer aus gewobenem Vinyl
Chemins de table en vinyle tissé



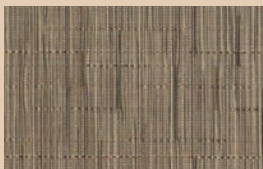
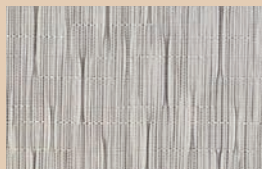
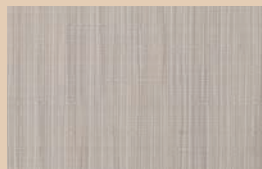
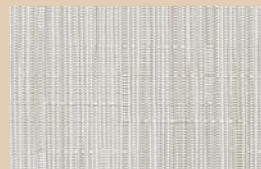
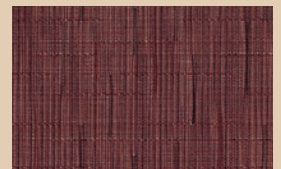
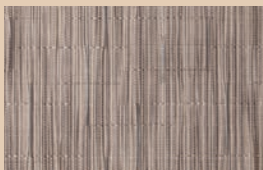
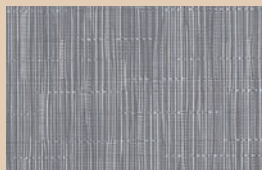
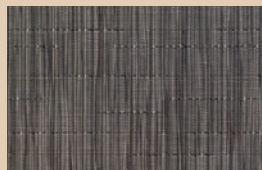
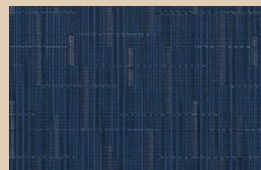
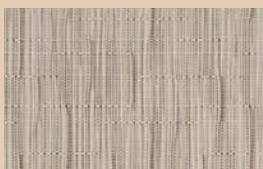
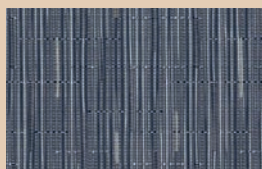
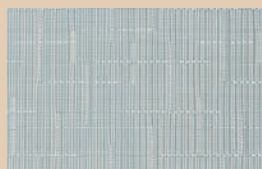
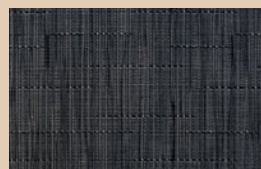
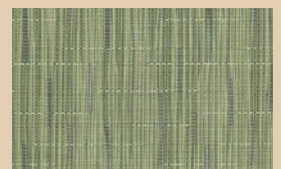

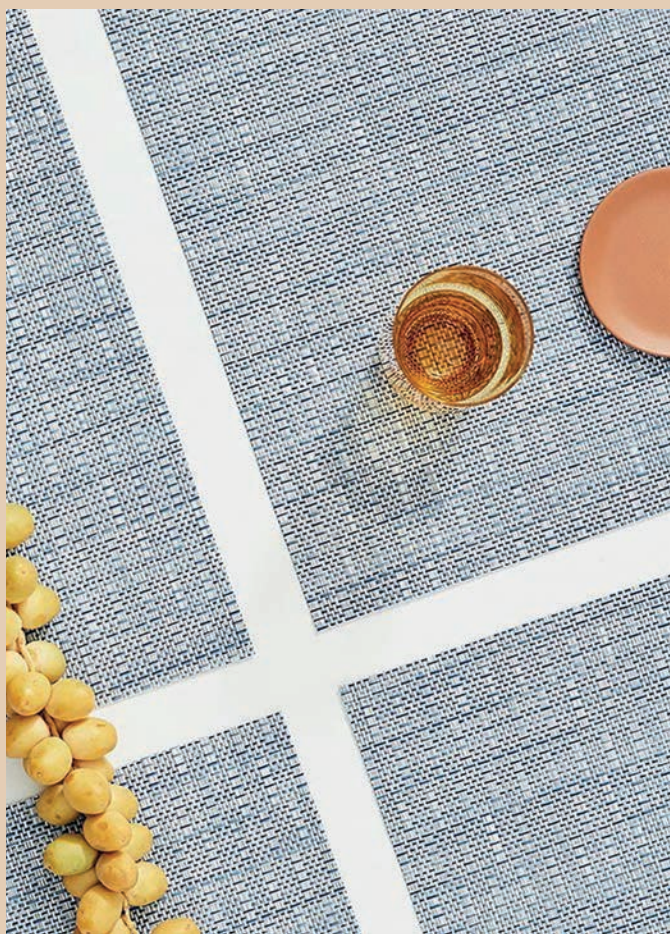

4232 xx 300	36 x 183 cm			99.80
-------------	-------------	--	--	-------

camel
63chalk
67chino
06coconut
34cranberry
71dune
58fog
30grey flannel
74lapis
02moonlight
37oat
69rain
33seaglass
31smoke
62spring green
35



THATCH

Tischsets aus gewobenem Vinyl
Sets de table en vinyle tissé

4287 xx 300	36 x 48 cm			25.75
4288 xx 300	30 x 41 cm			23.35
4289 xx 300	36 x 49 cm			28.15

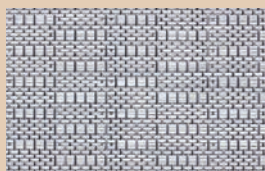

dove
03

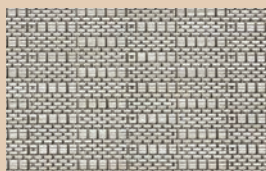

pebble
01

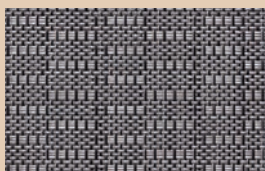

pewter
04

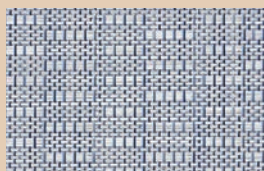

rain
02

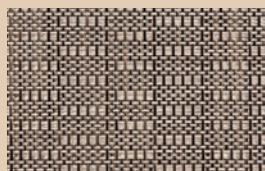

umber
05

tablemats & runners



OMBRÉ

Tischsets aus gewobenem Vinyl
Sets de table en vinyle tissé

4244 xx 300 36 x 48 cm



25.75

Tischläufer aus gewobenem Vinyl
Chemins de table en vinyle tissé

4245 xx 300 36 x 183 cm



99.80



gold
01



ink
05

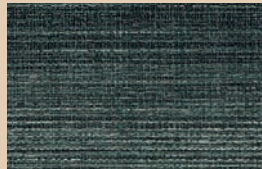

jade
04



natural
03

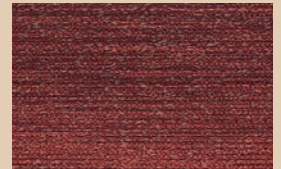

ruby
06

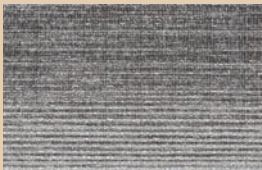

silver
02



sunrise
07



RIB WEAVE

Tischsets aus gewobenem Vinyl
Sets de table en vinyle tissé

4245 xx 300 36 x 48 cm   25.75

Tischläufer aus gewobenem Vinyl
Chemins de table en vinyle tissé

4246 xx 300 36 x 183 cm   99.80



birch
18



butterscotch
19

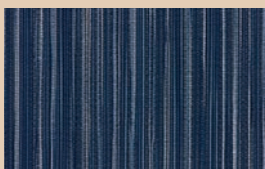

indigo
20

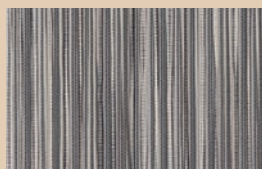

pearl
17

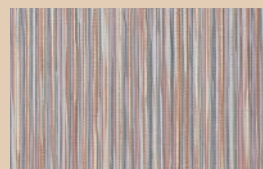

spice
21

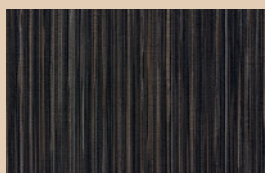



tigereye
16

tablemats & runners

**MOSAIC**

Tischsets aus gewobenem Vinyl
Sets de table en vinyle tissé

4275 xx 300	36 x 48 cm	 2		25.75
4277 xx 300	30 x 41 cm	 8	 24	23.35

Tischläufer aus gewobenem Vinyl
Chemins de table en vinyle tissé

4276 xx 300	36 x 183 cm	 8		99.80
-------------	-------------	---	---	-------



blue
21



grey
22



pink lemonade
09

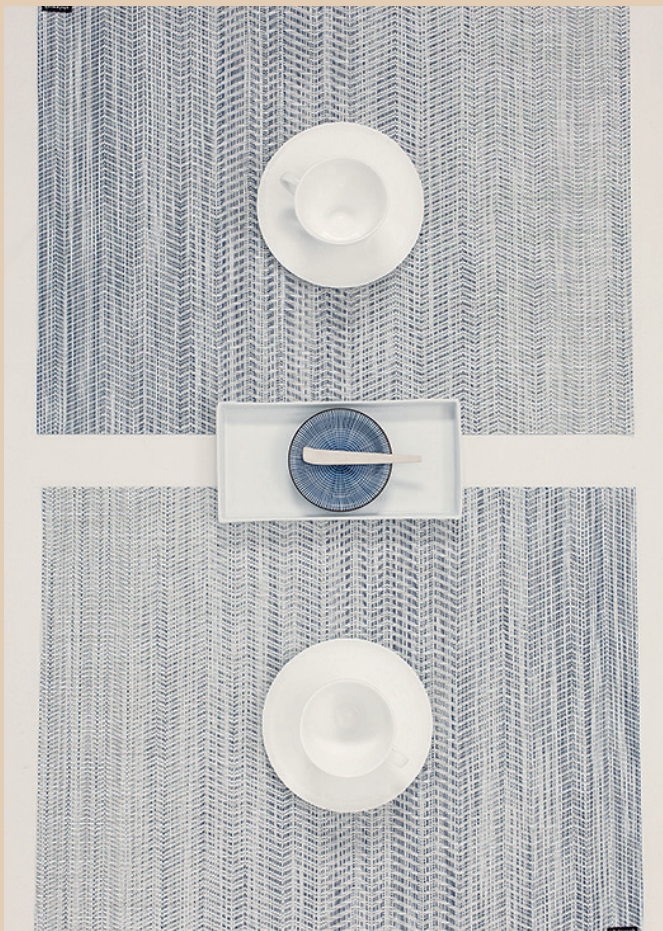

white/black
23

**WAVE**

Tischsets aus gewobenem Vinyl
Sets de table en vinyle tissé

4278 xx 300 36 x 48 cm



25.75

Tischläufer aus gewobenem Vinyl
Chemins de table en vinyle tissé

4279 xx 300 36 x 183 cm



99.80

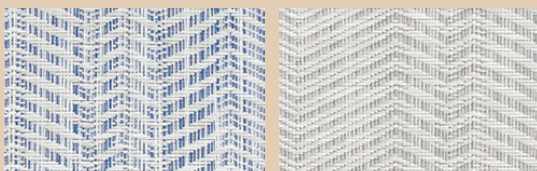

blue
31

grey
32

tablemats & runners

WORKTOP**DIE ULTIMATIVE ARBEITSOBERFLÄCHE - ENTWICKELT FÜR IHREN «PASS» IN DER KÜCHE****Eine problemlösende Innovation!**

Die Arbeitsplatte wurde entwickelt, um den funktionalen Anforderungen und ästhetischen Prioritäten der professionellen Küchen gerecht zu werden. Die Platte bringt die innovativen Textilien von Chilewich zum Einsatz und schützt die Arbeitsoberflächen mit eleganten, langlebigen und passgenauen Oberflächen. Die Unterseite ist mit einem wasserdichten, rutschfesten und antimikrobiellen Schutz aus Vinylschaum ausgestattet.

Die Worktops tragen auch dazu bei, den Bruch oder die Verschmutzung von Geschirr zu minimieren und Umgebungsgeräusche zu reduzieren. Grossküchen sind aber nur ein Bereich in dem die Worktops wunderbar einzusetzen sind. Die Arbeitsplatte ist ebenfalls ideal zum Schutz und zur Veredelung von unterschiedlichsten Oberflächen. Sie passen in ein breites Spektrum von Gastgewerbeumgebungen wie zum Beispiel: in Besprechungsräume, Firmenküchen, Bankettsäle oder auf Buffets.

WORKTOP**LA SURFACE DE TRAVAIL ULTIME - CONÇUE POUR VOTRE PASSAGE EN CUISINE****Une innovation qui règle tous les problèmes!**

Cette plaque de travail a été conçue pour répondre aux exigences fonctionnelles et aux priorités esthétiques d'une cuisine professionnelle. La plaque est composée de textile innovant de Chilewich et protège les surfaces de travail de façon élégante, durable et adaptée. La partie inférieure est revêtue d'une protection en mousse vinyle imperméable, antidérapante et antibactérienne.

Les revêtements Worktop évitent que la vaisselle ne se brise ou ne soit salie et atténuent les odeurs environnantes. Les grandes cuisines ne sont pas le seul espace où ces revêtements sont d'une grande utilité. Ces plaques de travail sont également idéales pour protéger et mettre en valeur des surfaces très diverses. Elles conviennent pour une grande variété d'espaces de restauration, par exemple: salles de réunion, cuisines d'entreprise, salles de banquet ou sur des buffets.





Die Worktop's werden auf Massgenau für Ihre Oberfläche hergestellt. Sie können aus vielen verschiedenen Chilewich-Webarten und Farben wählen.

Die Vorzüge:

- Schutz Ihrer Arbeitsoberfläche
- Geld- und Zeitsparender als improvisierte Leinenbezüge
- Vorbereitung und Abbau in kürzester Zeit.
- Die Arbeitsplatten können sauber abgewischt, geschruppt oder mit Wasser gewaschen werden.
- Dämpft die Geräusche
- Vermindert Bruch und Metallabrieb beim Geschirr
- Passgenau für Sie hergestellt
- Grosse Auswahl an verschiedenen Chilewich-Webarten und Farben

Kontaktieren Sie uns, wir beraten Sie gerne.

Les revêtements Worktop sont fabriqués sur mesure pour votre surface. Vous pouvez sélectionner la toile et la couleur parmi le large éventail de Chilewich.

Les avantages:

- Protège votre surface de travail
- Gain de temps et d'argent avec ce revêtement en toile improvisé
- Installation et retrait en un minimum de temps.
- Ces plaques de travail peuvent être essuyées, frottées ou nettoyées à l'eau.
- Atténue les odeurs
- Réduit les bris de vaisselle et l'abrasion par le métal
- Fabrication personnalisée
- Large sélection de toiles et de couleurs Chilewich

Contactez-nous, nous vous conseillons volontiers.

ziczac®



leather vegan



ziczac ist die Marke mit trendigen Produkten aus vegane-m Leder. Neueste Materialien und überraschende Innovationen werden mit trendigem Design und zeitgemä-ssen Produktlinien kombiniert. Die langlebige Qualität und die raffinierte Verarbeitung wird Sie begeistern!

Schöne Tischsets, ob rechteckig, rund oder steinförmig, bilden de-zente Details auf jedem Tisch. Ob mit weicher Ledertextur oder aus glattem PVC. Gefallen Ihnen Braun-Töne oder doch die aktuellen Pa-stellfarben? Sie finden in den 5 Serien bestimmt das Passende.

Auch Schürzen sind wieder angesagt! Küchen-, Bar- und Service-personal sieht man immer öfter in einer coolen Schürze. Schauen Sie sich unser vielfältiges Sortiment an. Dank veganem Leder sind die Schürzen um einiges leichter als echte Lederschürzen. Zudem sind diese sehr einfach zu reinigen.

ziczac est la marque de produits en cuir végan à la mode. Les derniers matériaux et les innovations surprenantes sont combinés avec un design tendance et des lignes de produits contemporaines. La qualité durable et la finition raffinée vas vous inspirer!

De magnifiques sets de table, qu'ils soient rectangulaires, ronds ou en forme de pierre, créent des détails uniques sur n'importe quelle table. Que ce soit avec une optique de cuir souple ou en PVC lisse. Vous aimez les tons bruns ou les couleurs pastel actuelles? Vous êtes sûr de trouver quelque chose de convenable dans une des 5 séries.

Les tabliers sont de nouveau à la mode! On voit de plus en plus souvent le personnel de cuisine, de bar et de service porter des ta-blis cool. Jetez un coup d'œil à notre gamme variée. Grâce au cuir végétal, les tabliers sont beaucoup plus légers que les tabliers en cuir véritable. Ils sont également très faciles à nettoyer.



LASER ODER STANZEN?

So prägt sich Ihr Logo beim Kunden ein.

Ihr Logo ist einzigartig und ruft bei Ihren Gästen sofort wieder die schönen Stunden hervor, welche diese bereits bei Ihnen verbringen durften.

Setzen Sie auf Details und zeigen Sie dezent Ihr Logo auf al-len ZICZAC Produkten, von der Schürze, über die Besteck-halter bis hin zu den Tischsets.

Ihre Gäste werden den Stolz, welcher hinter Ihrem Logo steht, bemerken und zu schätzen wissen.



LASER OU PERFORATION?

C'est ainsi que votre logo fait une impression sur le client.

Votre logo est unique et rappelle immédiatement à vos invités les heures agréables qu'ils ont déjà passées avec vous.

Concentrez-vous sur les détails et affichez votre logo discrètement sur tous les produits ZICZAC, du tablier aux porte-couverts en passant par les sets de table.

Vos invités remarqueront et apprécieront la fierté qui se cache derrière votre logo.

leather vegan

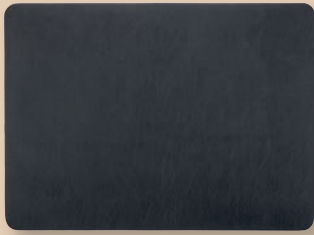

TOGO

Tischset rechteckig, Leder vegan
Set de table rectangulaire, cuir vegan

3000.40xxx

33 x 45 cm



8.95



001	004	009	010	011	012	019	020	021
schwarz noir	taupe	stone- blue	mauve	grau gris	grün vert	blau bleu	weiss blanc	dillgrün vert dill



TOGO

Tischset oval, Leder vegan
Set de table ovale, cuir vegan

3000.41xxx

33 x 45 cm



8.95



001	004	009	010	011	012	019	020	021
schwarz noir	taupe	stone- blue	mauve	grau gris	grün vert	blau bleu	weiss blanc	dillgrün vert dill

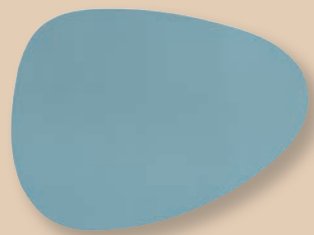

TOGO

Tischset steinförmig, Leder vegan
Set de table rocailleux, cuir vegan

3000.44xxx

43 x 32 cm



8.95



001	004	009	010	011	012	019	020	021
schwarz noir	taupe	stone- blue	mauve	grau gris	grün vert	blau bleu	weiss blanc	dillgrün vert dill



TOGO

Tischset rund, Leder vegan
Set de table rond, cuir vegan

3000.43xxx

Ø 38 cm



8.95



001	004	009	010	011	012	019	020	021
schwarz noir	taupe	stone- blue	mauve	grau gris	grün vert	blau bleu	weiss blanc	dillgrün vert dill



TOGO
Tischset, Leder vegan
Set de table, cuir vegan

3000.46xxx 48 x 32 cm



8.95

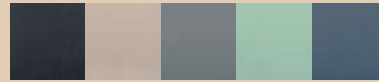

001	004	011	012	019
schwarz	taupe	grau	grün	blau
noir		gris	vert	bleu



TOGO
Centerpiece-Set oval, Leder vegan
Set à mettre centrale ovale, cuir vegan

3000.42xxx 33 x 70 cm



14.55



001	004	009	010	011	012	019
schwarz	taupe	stone-	mauve	grau	grün	blau
noir		blue		gris	vert	bleu

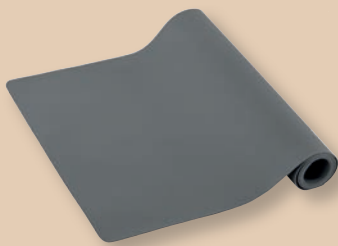

TOGO
Tischläufer, Leder vegan
Chemin de table, cuir vegan

3000.45xxx 45 x 145 cm



29.35



001	004	011
schwarz	taupe	grau
noir		gris



TOGO KIDS
Tischset rund, Leder vegan
Set de table rond, cuir vegan

3000.47xxx Ø 38 cm



8.95



019
blau
bleu



015
camel



010
mauve

leather vegan

TRAMONTANA
 Tischset rechteckig, Leder vegan
 Set de table rectangulaire, cuir vegan

 3000.23xxx 32 x 44 cm   6.95

 111
 caramel-schwarz
 caramel-noir

 211
 dunkelblau-grau
 bleu foncé-gris

 311
 creme-schwarz
 crème-noir

 411
 grün-grau
 vert-gris

TROJA
 Tischset rechteckig, Leder vegan
 Set de table rectangulaire, cuir vegan

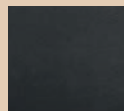
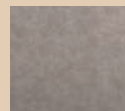
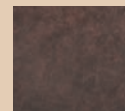
 3000.20xxx 33 x 45 cm   9.95

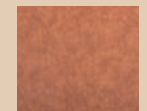
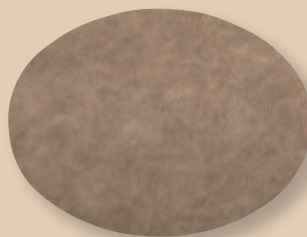
 001
 schwarz
 noir

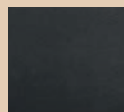
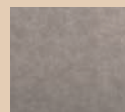
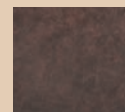
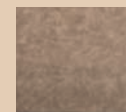
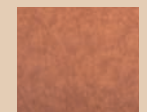
 002
 charcoal

 003
 coffee

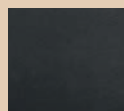
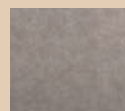
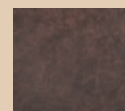
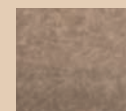
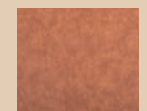
 004
 taupe

 006
 caramel

TROJA
 Tischset oval, Leder vegan
 Set de table ovale, cuir vegan

 3000.22xxx 33 x 45 cm   9.95

 001
 schwarz
 noir

 002
 charcoal

 003
 coffee

 004
 taupe

 006
 caramel

TROJA
 Tischläufer, Leder vegan
 Chemin de table, cuir vegan

 3000.21xxx 45 x 145 cm   29.35

 001
 schwarz
 noir

 002
 charcoal

 003
 coffee

 004
 taupe

 006
 caramel



TRUMAN
Tischset rechteckig, Leder vegan
Set de table rectangulaire, cuir vegan

3000.16xxx 33 x 45 cm   9.95



001 schwarz
noir 002 charcoal 003 coffee 004 taupe 005 walnuss
noyer

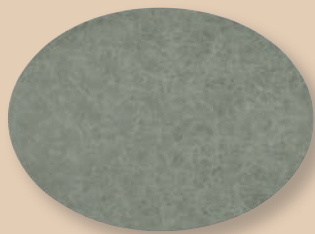

TRUMAN
Tischset oval, Leder vegan
Set de table ovale, cuir vegan

3000.17xxx 33 x 45 cm   9.95

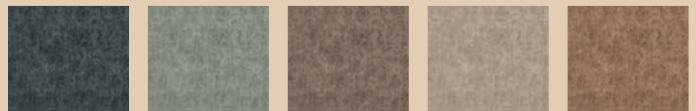

001 schwarz
noir 002 charcoal 003 coffee 004 taupe 005 walnuss
noyer



TRUMAN
Untersetzer 4 Stück, Leder vegan
Dessous de verre 4 pièces, cuir vegan

3000.19xxx Ø 9,5 cm   11.70/Set
(2.93 p.pc)

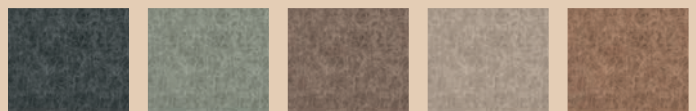

001 schwarz
noir 002 charcoal 003 coffee 004 taupe 005 walnuss
noyer



TRUMAN
Besteckhalter 2 Stück, Leder vegan
Porte couverts 2 pièces, cuir vegan

3000.18xxx 22,5 x 26 cm   23.50/Set
(11.75 p.pc)

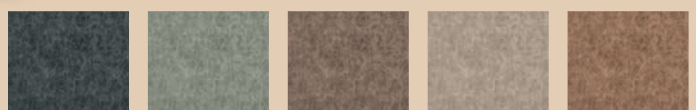

001 schwarz
noir 002 charcoal 003 coffee 004 taupe 005 walnuss
noyer

leather vegan



TRUMAN
Barber-Schürze, Leder vegan
Tablier-Barber, cuir vegan

Schürzen sind wieder total hip! Köche, Barkeeper oder auch Baristas tragen immer häufiger eine Schürze in Lederoptik. Die Schürzen sind leicht, angenehm zu tragen, waschbar und antibakteriell. Werfen Sie in Ruhe einen Blick auf unsere vielfältige Übersicht und finden Sie die richtige Schürze! Die genialen zizac-Produkte sind sowohl für den Hobbykoch als auch für den professionellen Meisterkoch und eine intensive Nutzung geeignet. Les tabliers sont à nouveau totalement branchés! Les chefs, barmen et baristas portent de plus en plus des tabliers d'aspect cuir. Les tabliers sont légers, confortables à porter, lavables et antibactériens. Vérifier notre aperçu diversifiée et trouvez le bon tablier! Les produits ingénieux de zizac conviennent au cuisinier amateur ainsi qu'au maître cuisinier professionnel et à une utilisation intensive.

3000.12xxx 64 x 85 cm



69.35



001
schwarz
noir

002
charcoal

003
coffee

004
taupe

005
walnuss
noyer



TRUMAN
Schürze mit Lasche, Leder vegan
Tablier à onglet, cuir vegan

Schürzen sind wieder total hip! Köche, Barkeeper oder auch Baristas tragen immer häufiger eine Schürze in Lederoptik. Die Schürzen sind leicht, angenehm zu tragen, waschbar und antibakteriell. Werfen Sie in Ruhe einen Blick auf unsere vielfältige Übersicht und finden Sie die richtige Schürze! Die genialen zizac-Produkte sind sowohl für den Hobbykoch als auch für den professionellen Meisterkoch und eine intensive Nutzung geeignet. Les tabliers sont à nouveau totalement branchés! Les chefs, barmen et baristas portent de plus en plus des tabliers d'aspect cuir. Les tabliers sont légers, confortables à porter, lavables et antibactériens. Vérifier notre aperçu diversifiée et trouvez le bon tablier! Les produits ingénieux de zizac conviennent au cuisinier amateur ainsi qu'au maître cuisinier professionnel et à une utilisation intensive.

3000.11xxx 70 x 90 cm



57.60



001
schwarz
noir

002
charcoal

003
coffee

004
taupe

005
walnuss
noyer



TRUMAN
Schürze mit Tasche, Leder vegan
Tablier avec poche, cuir vegan

Schürzen sind wieder total hip! Köche, Barkeeper oder auch Baristas tragen immer häufiger eine Schürze in Lederoptik. Die Schürzen sind leicht, angenehm zu tragen, waschbar und antibakteriell. Werfen Sie in Ruhe einen Blick auf unsere vielfältige Übersicht und finden Sie die richtige Schürze! Die genialen zizac-Produkte sind sowohl für den Hobbykoch als auch für den professionellen Meisterkoch und eine intensive Nutzung geeignet. Les tabliers sont à nouveau totalement branchés! Les chefs, barmen et baristas portent de plus en plus des tabliers d'aspect cuir. Les tabliers sont légers, confortables à porter, lavables et antibactériens. Vérifier notre aperçu diversifiée et trouvez le bon tablier! Les produits ingénieux de zizac conviennent au cuisinier amateur ainsi qu'au maître cuisinier professionnel et à une utilisation intensive.

3000.10xxx 64 x 85 cm   65.85

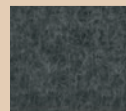

001
schwarz
noir



002
charcoal



003
coffee

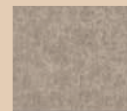

004
taupe

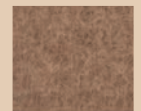

005
walnuss
noyer



TRUMAN
Schürze mit Accessoiretasche, Leder vegan
Tablier avec sac accessoires, cuir vegan

3000.13xxx 70 x 45 cm   45.85

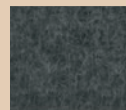

001
schwarz
noir



002
charcoal



003
coffee

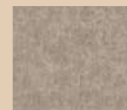

004
taupe



005
walnuss
noyer



TRUMAN
Accessoiretasche, Leder vegan
Sac d'accessoires, cuir vegan

3000.15xxx 13 x 6 x 16 cm   14.55



001
schwarz
noir

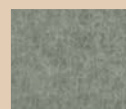

002
charcoal

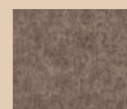

003
coffee

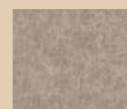

004
taupe



005
walnuss
noyer

zafferano





lampes à porter





POLDINA TAVOLO PRO
LED-Tischleuchte
Lampe de table à LED

Akkubetriebene, tragbare und wiederaufladbare LED-Tischleuchte. Sie ist ausgestattet mit: Kontaktladestation und Dimmer-Berührungssteuerung. Gehäuse aus lackiertem Aluminiumdruckguss, Lithium-Akku-Pack (wiederaufladbar und austauschbar). Der Akku hält bei voller Leistung etwa 9 Stunden, Ladezeit bei etwa 6 Stunden. Für den Aussen- und Inneneinsatz geeignet (Verwendung in Innenräumen inkl. Ladestation möglich)
Lampe de table LED à piles, portable et rechargeable. Elle est équipée de: Station de charge à contact et commande tactile variableur. Boîtier en aluminium moulé sous pression laqué, bloc-batterie au lithium (rechargeable et remplaçable). La batterie dure 9 heures environ à pleine capacité, le temps de charge est de 6 heures environ. Convient à une utilisation à l'extérieur et à l'intérieur (utilisation à l'intérieur avec station de charge possible)

4410010xx Ø 11 cm x H 38 cm   139.80

gold leaf | silver leaf | copper leaf

4410010xx Ø 11 cm x H 38 cm   211.50



lampes à porter

01
White02
Dark grey03
Corten04
Sand**POLDINA MINI TAVOLO PRO**
LED-Tischleuchte
Lampe de table à LED

Akkubetriebene, tragbare und wiederaufladbare LED-Tischleuchte. Sie ist ausgestattet mit: Kontaktladestation und Dimmer-Berührungssteuerung. Gehäuse aus lackiertem Aluminiumdruckguss, Lithium-Akku-Pack (wiederaufladbar und austauschbar). Der Akku hält bei voller Leistung etwa 9 Stunden, Ladezeit bei etwa 6 Stunden. Für den Aussen- und Inneneinsatz geeignet (Verwendung in Innenräumen inkl. Ladestation möglich)

Lampe de table LED à piles, portable et rechargeable. Elle est équipée de: Station de charge à contact et commande tactile variateur. Boîtier en aluminium moulé sous pression laqué, bloc-batterie au lithium (rechargeable et remplaçable). La batterie dure 9 heures environ à pleine capacité, le temps de charge est de 6 heures environ. Convient à une utilisation à l'extérieur et à l'intérieur (utilisation à l'intérieur avec station de charge possible)

4410020xx Ø 11 cm x H 30 cm



139.80

01
White02
Dark grey03
Corten04
Sand06
Sage green**POLDINA REVERSO**
LED-Tischleuchte
Lampe de table à LED

Akkubetriebene, tragbare und wiederaufladbare LED-Tischleuchte mit einem Mehrzweckbehälter. Im unteren Teil des Kopfes befindet sich ein Touch-Dimmer, mit dem sich die Leuchte einschalten, die Lichtintensität einstellen und die Lichtfarbtemperatur (2200 K, 2700 K oder 3000 K) wählen lässt. Sie ist für den Innen- und Aussenbereich geeignet. Verwendung in Innenräumen inkl. Ladestation möglich. Gehäuse aus lackiertem Aluminiumdruckguss, Lithium-Akku-Pack (wiederaufladbar und austauschbar). Der Mehrzweckbehälter (18 cl Inhalt) aus lebensmittelechtem Thermoplast (PET) ist abnehmbar und wiederverwendbar. Die Leuchte wird mit einer Kontaktladestation geliefert; das Ladegerät ist im Lieferumfang enthalten. Der Akku hält bei voller Leistung etwa 12 Stunden, Ladezeit bei etwa 6-7 Stunden.

Lampe de table LED à piles, portable et rechargeable, avec un réservoir polyvalent. Dans la partie inférieure de la tête se trouve un variateur tactile qui permet d'allumer la lampe, de régler l'intensité lumineuse et de choisir la température de couleur de la lumière (2200 K, 2700 K ou 3000 K). Elle convient pour l'intérieur et l'extérieur. Utilisation possible à l'intérieur, station de recharge incluse. Boîtier en aluminium laqué, moulé sous pression, bloc-batterie au lithium (rechargeable et remplaçable). La lampe est livrée avec une station de charge par contact; le chargeur est inclus dans la livraison. La batterie dure environ 12 heures à pleine puissance, le temps de charge est d'environ 6-7 heures.

4410050xx Ø 11 cm x H 35 cm

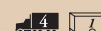

141.00

01
White02
Dark grey03
Corten11
Capri blue12
Lila13
Apple green14
Orange

OLIVIA MINI LED-Tischleuchte Lampe de table à LED

Akkubetriebene, tragbare und wiederaufladbare LED-Tischleuchte. Am oberen Ende des Lampenkopfes befindet sich ein Touch-Dimmer, mit dem sich die Leuchte einschalten, die Lichtintensität einstellen und die Lichtfarbtemperatur (2700 K oder 3000 K) wählen lässt. Sie ist für den Innen- und Aussenbereich geeignet. Verwendung in Innenräumen inkl. Ladestation möglich. Gehäuse aus lackiertem Aluminiumdruckguss, Lithium-Akku-Pack (wiederaufladbar und austauschbar). Die Leuchte wird mit einer Kontaktladestation geliefert; das Ladegerät ist im Lieferumfang enthalten. Der Akku hält bei voller Leistung etwa 9 Stunden, Ladezeit bei etwa 6 Stunden.

Lampe de table LED à piles, portable et rechargeable. En haut de la tête de la lampe se trouve un variateur tactile qui permet d'allumer la lampe, de régler l'intensité lumineuse et de choisir la température de couleur de la lumière (2700 K ou 3000 K). Elle convient pour l'intérieur et l'extérieur. Utilisation possible à l'intérieur, station de recharge incluse. Boîtier en aluminium laqué, moulé sous pression, bloc-batterie au lithium (rechargeable et remplaçable). La lampe est livrée avec une station de charge par contact; le chargeur est inclus dans la livraison. La batterie dure environ 9 heures à pleine puissance, le temps de charge est d'environ 6 heures.

4410060xx

Ø 11 cm x H 22 cm



93.85

01
White02
Dark grey03
Corten11
Gold Leaf12
Silver Leaf13
Copper Leaf

OLIVIA TAVOLO PRO LED-Tischleuchte Lampe de table à LED

Akkubetriebene, tragbare und wiederaufladbare LED-Tischleuchte. Sie ist ausgestattet mit: Kontaktladestation und Dimmer-Berührungssteuerung. Gehäuse aus lackiertem Aluminiumdruckguss, Lithium-Akku-Pack (wiederaufladbar und austauschbar). Der Akku hält bei voller Leistung etwa 9 Stunden, Ladezeit bei etwa 6 Stunden. Für den Aussen- und Inneneinsatz geeignet (Verwendung in Innenräumen inkl. Ladestation möglich)

Lampe de table LED à piles, portable et rechargeable. Elle est équipée de: Station de charge à contact et commande tactile variateur. Boîtier en aluminium moulé sous pression laqué, bloc-batterie au lithium (rechargeable et remplaçable). La batterie dure 9 heures environ à pleine capacité, le temps de charge est de 6 heures environ. Convient à une utilisation à l'extérieur et à l'intérieur (utilisation à l'intérieur avec station de charge possible)

4410030xx

Ø 11 cm x H 35 cm



93.85

gold leaf | silver leaf | copper leaf

4410030xx

Ø 11 cm x H 35 cm



176.20

lampes à porter



zafferano

PINA
 LED-Tischleuchte
 Lampe de table à LED

Akkubetriebene, tragbare und wiederaufladbare LED-Tischleuchte. Der Touch-Dimmer am Sockel ermöglicht das Ein- und Ausschalten sowie das Dimmen. Sie ist für den Innen- und Aussenbereich geeignet (ausgenommen Gold-, Silber- und Kupferoberflächen). Verwendung in Innenräumen inkl. Ladestation möglich. Gehäuse aus lackiertem Aluminiumdruckguss, Lithium-Akku-Pack (wiederaufladbar und austauschbar). Die Leuchte wird mit einer Kontaktladestation geliefert; das Ladegerät ist im Lieferumfang enthalten. Der Akku hält bei voller Leistung etwa 12 Stunden, Ladezeit bei etwa 6-7 Stunden.

Lampe de table LED à piles, portable et rechargeable. Le variateur tactile situé sur le socle permet d'allumer, d'éteindre et de faire varier l'intensité lumineuse. Elle convient pour l'intérieur et l'extérieur (à l'exception des couleurs or, argent et cuivre). Utilisation possible à l'intérieur, station de recharge incluse. Boîtier en aluminium laqué, bloc-batterie au lithium (rechargeable et remplaçable). La lampe est livrée avec une station de charge par contact; le chargeur est inclus dans la livraison. La batterie dure environ 12 heures à pleine puissance, le temps de charge est d'environ 6-7 heures.

4410070xx Ø 10,5 cm x H 38 cm   105.60

gold leaf | silver leaf | copper leaf

4410070xx Ø 10,5 cm x H 38 cm   152.70

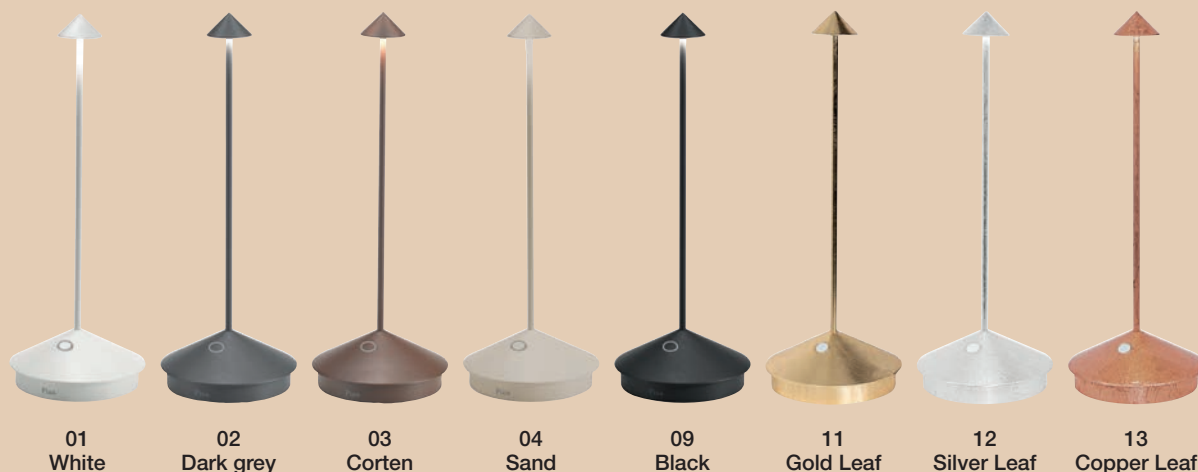

zafferano

**HOME**
LED-Tischleuchte
Lampe de table à LED

Akkubetriebene, tragbare und wiederaufladbare LED-Tischleuchte. Die geometrische Form erinnert an eine moderne Laterne. Die LED-Lichtquelle ist im oberen Teil der Aluminiumstruktur untergebracht und gibt direktes Licht nach unten ab. Die Leuchte ist ausgestattet mit: Kontaktladestation und Dimmer-Berührungssteuerung. Der Akku hält bei voller Leistung etwa 12 Stunden, Ladezeit bei etwa 6 Stunden. Für den Aussen- und Inneneinsatz geeignet (Verwendung in Innenräumen inkl. Ladestation möglich).

Lampe de table LED portable alimentée par batterie rechargeable. Sa forme géométrique rappelle une lanterne moderne. La source lumineuse LED est logée dans la partie supérieure de la structure en aluminium et émet une lumière directe vers le bas. La lampe est équipée de: Station de charge à contact et commande tactile variableur. La batterie dure 12 heures environ à pleine capacité, le temps de charge est de 6 heures environ. Convient à une utilisation à l'extérieur et à l'intérieur (utilisation à l'intérieur avec station de charge possible).

4410040xx 10 x 10 cm x H 29,3 cm   116.35



01
White



02
Dark Grey



03
Corten

lampes à porter

Ladestation USB
Station de charge USB

USB-Ladegerät mit mehreren Steckdosen (8 x USB-A), ein grafisches Display zeigt den Ladezustand der Akkus an, besonders geeignet für den professionellen Einsatz, passend für Poldina Tavolo Pro, Poldina Mini Tavolo Pro und Olivia Tavolo Pro
 Chargeur USB avec plusieurs prises (8 x USB-A), un écran graphique indique l'état de charge des batteries, particulièrement adapté à un usage professionnel, convient à Poldina Tavolo Pro, Poldina Mini Tavolo Pro et Olivia Tavolo Pro.

441002000



58.55

POLDINA
Ladestation 6 Lampen
Station de charge 6 lampes

Modulare Multikontakt-Ladestation für max. 6 Tischlampen, passend für Poldina Tavolo Pro und Poldina Mini Tavolo Pro. Es können mehrere Ladestationen nacheinander angeschlossen werden, um mehrere Lampen gleichzeitig zu laden. Besonders geeignet für den professionellen Einsatz.

Station de charge modulaire multi-contact pour 6 lampes de table maximum, adaptée à Poldina Tavolo Pro et Poldina Mini Tavolo Pro. Plusieurs stations de charge peuvent être connectées l'une après l'autre pour charger plusieurs lampes simultanément. Particulièrement adapté à un usage professionnel.

441001000

51 x 31 cm

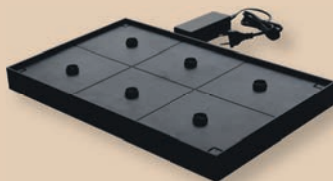
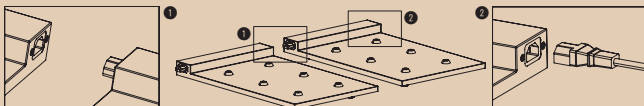

152.70

OLIVIA
Ladestation 6 Lampen
Station de recharge 6 Lampes

Modulare Multikontakt-Ladestation für max. 6 Tischlampen, passend für Olivia Tavolo Pro. Mit den mitgelieferten Stäben können mehrere Ladestationen gestapelt werden (max. 3 Ebenen), um mehrere Lampen gleichzeitig zu laden. Besonders geeignet für den professionellen Einsatz.

Station de charge modulaire multi-contact pour max. 6 lampes de table, adaptée à Olivia Tavolo Pro. Avec les tiges fournies, plusieurs stations de charge peuvent être empilés (3 niveaux maximum) pour charger plusieurs lampes simultanément. Particulièrement adapté à un usage professionnel.

441003000

47 x 29 cm



152.70

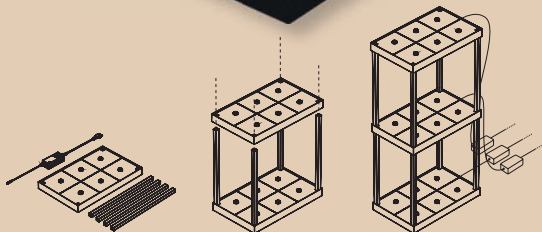



BRÄTER 474

KOCHTÖPFE 479

PFANNEN 483

SCHÖPF-/KOCHGERÄTE 488

KÜCHENUTENSILIEN 497

SCHNEIDEBRETTER 511

MESSER, SCHNEIDGERÄTE 514

Victorinox

KAI

GASTRONORM 527

Inox

Porzellan

Melamin

Copolyester

Polycarbonat

Polypropylen

Silikon-Deckel

FOOD-BOXEN 545

KONDIATORENUTENSILIEN 546

PIZZA-PASTAUTENSILIEN 558

THERMOMETER 561

ETIKETIERGERÄTE 564

COCOTTES 474

CASSEROLES 479

POÊLES 483

ACCESSOIRES P. LA CUISSON 488

USTENSILES DE CUISINE 497

PLANCHES À DECOUPER 511

COUTELLERIE 514

Victorinox

KAI

GASTRONORME 527

Inox

Porcelaine

Mélamine

Copolyester

Polycarbonat

Polypropylène

Couvercles silicone

BACS À FOOD 545



USTENSILE À PÂTISSERIES 546

USTENSILES DE PIZZA-PASTA 558

THERMOMÈTRES 561

ETIQUETEUSES 564

KÜCHE CUISINE

	Schwarze Artikelnummern: Numéros de référence noirs:	Lagerartikel (Zwischenverkauf vorbehalten) article en stock (sous réserve de vente intermédiaire)
	Grüne Artikelnummern: Numéros de référence verts :	Lieferzeit 2 bis max. 4 Wochen délai de livraison 2 à max. 4 semaines
	Rote Artikelnummern: Numéros de référence rouges:	Lieferzeit 4 bis max. 12 Wochen (Sonderanfertigungen) délai de livraison 4 à max. 12 semaines (réalisations spéciales)

Bei Lieferfristen von über 12 Wochen werden Sie informiert.
En cas de livraison de plus de 12 semaines, vous serez informés.

BRÄTER / COCOTTES

**LE CREUSET «Signature»
Bräter aus Gusseisen
Cocotte en fonte émaillée**

Schwarz matt, geeignet für Backofen, Herd, Induktion oder Backofen mit Grillfunktion.
Noir mat, passe au four, sur les plaques de cuisson, y compris à induction, et même sous le grill.

**Rund
Ronde**

Art-Nr./No d'article	Grösse/grandeur	Preis/prix
8001.21001	1,8 L / Ø 18 cm	305.85
8001.21002	2,4 L / Ø 20 cm	351.70
8001.21003	3,3 L / Ø 22 cm	376.40
8001.21004	4,2 L / Ø 24 cm	423.50
8001.21005	5,3 L / Ø 26 cm	469.35
8001.21006	6,7 L / Ø 28 cm	564.65

**Oval
Ovale**

Art-Nr./No d'article	Grösse/grandeur	Preis/prix
8001.21007	4,1 L / 27 cm	423.50
8001.21008	4,7 L / 29 cm	469.35
8001.21009	6,3 L / 31 cm	505.70

**LE CREUSET «Signature»
Bräter aus Gusseisen
Cocotte en fonte émaillée**

Kirschrot, geeignet für Backofen, Herd, Induktion oder Backofen mit Grillfunktion.
Cherise, passe au four, sur les plaques de cuisson, y compris à induction, et même sous le grill.

**Rund
Ronde**

Art-Nr./No d'article	Grösse/grandeur	Preis/prix
8001.22001	1,8 L / Ø 18 cm	305.85
8001.22002	2,4 L / Ø 20 cm	351.70
8001.22003	3,3 L / Ø 22 cm	376.40
8001.22004	4,2 L / Ø 24 cm	423.50
8001.22005	5,3 L / Ø 26 cm	469.35
8001.22006	6,7 L / Ø 28 cm	564.65

**Oval
Ovale**

Art-Nr./No d'article	Grösse/grandeur	Preis/prix
8001.22007	4,1 L / 27 cm	423.50
8001.22008	4,7 L / 29 cm	469.35
8001.22009	6,3 L / 31 cm	505.70

**LE CREUSET «Signature»
Bräter aus Gusseisen
Cocotte en fonte émaillée**

Ofenrot, geeignet für Backofen, Herd, Induktion oder Backofen mit Grillfunktion.
Volcanique, passe au four, sur les plaques de cuisson, y compris à induction, et même sous le grill.

**Rund
Ronde**

Art-Nr./No d'article	Grösse/grandeur	Preis/prix
8001.23001	1,8 L / Ø 18 cm	305.85
8001.23002	2,4 L / Ø 20 cm	351.70
8001.23003	3,3 L / Ø 22 cm	376.40
8001.23004	4,2 L / Ø 24 cm	423.50
8001.23005	5,3 L / Ø 26 cm	469.35
8001.23006	6,7 L / Ø 28 cm	564.65

**Oval
Ovale**

Art-Nr./No d'article	Grösse/grandeur	Preis/prix
8001.23007	4,1 L / 27 cm	423.50
8001.23008	4,7 L / 29 cm	469.35
8001.23009	6,3 L / 31 cm	505.70

**LE CREUSET «Signature»
Bräter aus Gusseisen
Cocotte en fonte émaillée**

Azure, geeignet für Backofen, Herd, Induktion oder Backofen mit Grillfunktion.
Azure, passe au four, sur les plaques de cuisson, y compris à induction, et même sous le grill.

**Rund
Ronde**

Art-Nr./No d'article	Grösse/grandeur	Preis/prix
8001.24001	1,8 L / Ø 18 cm	305.85
8001.24002	2,4 L / Ø 20 cm	351.70
8001.24003	3,3 L / Ø 22 cm	376.40
8001.24004	4,2 L / Ø 24 cm	423.50
8001.24005	5,3 L / Ø 26 cm	469.35
8001.24006	6,7 L / Ø 28 cm	564.65

**Oval
Ovale**

Art-Nr./No d'article	Grösse/grandeur	Preis/prix
8001.24007	4,1 L / 27 cm	423.50
8001.24008	4,7 L / 29 cm	469.35
8001.24009	6,3 L / 31 cm	505.70



CHASSEUR
Bräter aus Gusseisen
Cocotte en fonte émaillée

Gusseisen, rot glänzend, mit auswechselbaren Deckelgriffen: 1 Messinggriff und 1 Edelstahlgriff speziell für den Backofen
Acier fonte, rouge vernis, cocottes livrées avec 2 boutons: 1 laiton et 1 inox special four

Rund
Ronde

Art-Nr./No d'article	Grösse/grandeur	Preis/prix
8006.98201	1,8 L / Ø 18 x H 13,0 cm	183.50
8006.98202	2,5 L / Ø 20 x H 13,5 cm	206.95
8006.98203	4,0 L / Ø 24 x H 16,0 cm	254.05
8006.98204	6,1 L / Ø 28 x H 18,0 cm	324.65

Oval
Ovale

Art-Nr./No d'article	Grösse/grandeur	Preis/prix
8006.98205	3,6L / 27,0x20,0xH16,5 cm	272.90
8006.98206	5,6L / 31,0x26,0xH17,0 cm	336.40



CHASSEUR
Bräter aus Gusseisen
Cocotte en fonte émaillée

Gusseisen, braun glänzend, mit auswechselbaren Deckelgriffen: 1 Messinggriff und 1 Edelstahlgriff speziell für den Backofen
Acier fonte, marron vernis, cocottes livrées avec 2 boutons: 1 laiton et 1 inox special four

Rund
Ronde

Art-Nr./No d'article	Grösse/grandeur	Preis/prix
8006.98211	1,0 L / Ø 14 x H 12,5 cm	139.90
8006.98212	1,8 L / Ø 18 x H 13,0 cm	183.50
8006.98213	4,0 L / Ø 24 x H 16,0 cm	254.05
8006.98214	6,1 L / Ø 28 x H 18,0 cm	324.65

Oval
Ovale

Art-Nr./No d'article	Grösse/grandeur	Preis/prix
8006.98215	4,0L / 27,0x20,0xH16,5 cm	272.90
8006.98216	6,0L / 31,0x26,0xH17,0 cm	336.40



CHASSEUR
Bräter aus Gusseisen
Cocotte en fonte émaillée

Gusseisen, schwarz matt, mit auswechselbaren Deckelgriffen: 1 Messinggriff und 1 Edelstahlgriff speziell für den Backofen
Acier fonte, noir mat, cocottes livrées avec 2 boutons: 1 laiton et 1 inox special four

Rund
Ronde

Art-Nr./No d'article	Grösse/grandeur	Preis/prix
8006.98300	0,35L / Ø 10 x H 9,0 cm	96.20
8006.98301	0,6L / Ø 12 x H 10,1 cm	123.50
8006.98302	0,9L / Ø 14 x H 12,5 cm	139.90
8006.98303	1,8L / Ø 18 x H 13,0 cm	183.50
8006.98304	2,5L / Ø 20 x H 13,5 cm	206.95
8006.98305	4,0L / Ø 24 x H 16,0 cm	254.05
8006.98306	6,1L / Ø 28 x H 18,0 cm	324.65
8006.98307	8,8L / Ø 32 x H 19,0 cm	435.25

Oval
Ovale

Art-Nr./No d'article	Grösse/grandeur	Preis/prix
8006.98308	1,0L / 21,7x17,7xH11,8 cm	171.70
8006.98309	3,2L / 30,5x19,5xH16,5 cm	230.50
8006.98310	4,0L / 33,0x20,0xH16,5 cm	272.90
8006.98311	6,0L / 38,0x26,0xH17,0 cm	336.40
8006.98312	8,5L / 43,0x28,0xH19,0 cm	423.50



WMF «Fusintec Mineral»
Bratentopf mit Glasdeckel
Cocotte avec couvercle en verre

Dark Brass, geeignet für Induktion, Gas, Glaskeramik oder Halogen. Spülmaschinengeeignet aber Spülen per Hand empfohlen.
Dark Brass, convient pour induction, gaz, vitro-céramique ou halogène. Passe au lave-vaisselle, mais le lavage à la main est recommandé.

Art-Nr./No d'article	Grösse/grandeur	Preis/prix
05.1457.5290	2,4 L / Ø 20 cm x H 8,5 cm	149.95
05.1467.5290	4,4 L / Ø 24 cm x H 10,5 cm	173.95



WMF «Fusintec Mineral»
Bratentopf mit Glasdeckel
Cocotte avec couvercle en verre

Platinum, geeignet für Induktion, Gas, Glaskeramik oder Halogen. Spülmaschinengeeignet aber Spülen per Hand empfohlen.
Platinum, convient pour induction, gaz, vitro-céramique ou halogène. Passe au lave-vaisselle, mais le lavage à la main est recommandé.

Art-Nr./No d'article	Grösse/grandeur	Preis/prix
05.1458.5290	2,4 L / Ø 20 cm x H 8,5 cm	149.95
05.1468.5290	4,4 L / Ø 24 cm x H 10,5 cm	173.95



WMF «Fusintec Mineral»
Bratentopf mit Glasdeckel
Cocotte avec couvercle en verre

Rose Quartz, geeignet für Induktion, Gas, Glaskeramik oder Halogen. Spülmaschinengeeignet aber Spülen per Hand empfohlen.
Rose Quartz, convient pour induction, gaz, vitro-céramique ou halogène. Passe au lave-vaisselle, mais le lavage à la main est recommandé.

Art-Nr./No d'article	Grösse/grandeur	Preis/prix
05.1459.5290	2,4 L / Ø 20 cm x H 8,5 cm	149.95
05.1469.5290	4,4 L / Ø 24 cm x H 10,5 cm	173.95



WMF
Porzellaneinsatz für Töpfe
Insert en porcelaine pour casseroles

Art-Nr./No d'article	Grösse/grandeur	Preis/prix
17.7920.9801	Ø 20 cm x H 7,5 cm	34.65
17.7924.9801	Ø 24 cm x H 8,0 cm	49.35



Deckelhalter
Support de couvercle

Art-Nr./No d'article	Grösse/grandeur	Preis/prix
8005.60430	12 cm x H 8 cm	52.90

BRÄTER / COCOTTES

**HOELLER «AluChef»
Bräter aus Aluminium
Cocotte en alu**

Aluminium, geeignet für Backofen, Herd, Induktion oder Backofen mit Grillfunktion. *alu, passe au four, sur les plaques de cuisson, y compris à induction, et même sous le grill.*

**Rund
Ronde**

Art-Nr./No d'article	Grösse/grandeur	Preis/prix
650-200005	2,43 L / Ø 20 x H 8,3 cm	117.40
650-240005	4,26 L / Ø 24 x H 10,2 cm	152.70
650-280005	6,8 L / Ø 28 x H 12 cm	187.90

**Oval
Ovale**

Art-Nr./No d'article	Grösse/grandeur	Preis/prix
650-352905	7,5 L / 35 x 29 x H 10,5 cm	205.75

**HOELLER «AluChef»
Bräter aus Aluminium
Cocotte en alu**

Aluminium, geeignet für Backofen, Herd, Induktion oder Backofen mit Grillfunktion. *alu, passe au four, sur les plaques de cuisson, y compris à induction, et même sous le grill.*

**Rund
Ronde**

Art-Nr./No d'article	Grösse/grandeur	Preis/prix
650-200004	2,43 L / Ø 20 x H 8,3 cm	117.40
650-240004	4,26 L / Ø 24 x H 10,2 cm	152.70
650-280004	6,8 L / Ø 28 x H 12 cm	187.90

**Oval
Ovale**

Art-Nr./No d'article	Grösse/grandeur	Preis/prix
650-352904	7,5 L / 35 x 29 x H 10,5 cm	205.75

**HOELLER «AluChef»
Bräter aus Aluminium
Cocotte en alu**

Aluminium, geeignet für Backofen, Herd, Induktion oder Backofen mit Grillfunktion. *alu, passe au four, sur les plaques de cuisson, y compris à induction, et même sous le grill.*

**Rund
Ronde**

Art-Nr./No d'article	Grösse/grandeur	Preis/prix
650-200008	2,43 L / Ø 20 x H 8,3 cm	117.40
650-240008	4,26 L / Ø 24 x H 10,2 cm	152.70
650-280008	6,8 L / Ø 28 x H 12 cm	187.90

**Oval
Ovale**

Art-Nr./No d'article	Grösse/grandeur	Preis/prix
650-352908	7,5 L / 35 x 29 x H 10,5 cm	205.75

**HOELLER «AluChef»
Bräter aus Aluminium
Cocotte en alu**

Aluminium, geeignet für Backofen, Herd, Induktion oder Backofen mit Grillfunktion. *alu, passe au four, sur les plaques de cuisson, y compris à induction, et même sous le grill.*

**Rund
Ronde**

Art-Nr./No d'article	Grösse/grandeur	Preis/prix
650-200012	2,43 L / Ø 20 x H 8,3 cm	117.40
650-240012	4,26 L / Ø 24 x H 10,2 cm	152.70
650-280012	6,8 L / Ø 28 x H 12 cm	187.90

**Oval
Ovale**

Art-Nr./No d'article	Grösse/grandeur	Preis/prix
650-352912	7,5 L / 35 x 29 x H 10,5 cm	205.75

**HOELLER «AluChef»
Bräter aus Aluminium
Cocotte en alu**

Schwarz matt, geeignet für Backofen, Herd, Induktion oder Backofen mit Grillfunktion. *Noir mat, passe au four, sur les plaques de cuisson, y compris à induction, et même sous le grill.*

**Rund
Ronde**

Art-Nr./No d'article	Grösse/grandeur	Preis/prix
650-200011	2,43 L / Ø 20 x H 8,3 cm	117.40
650-240011	4,26 L / Ø 24 x H 10,2 cm	152.70
650-280011	6,8 L / Ø 28 x H 12 cm	187.90

**Oval
Ovale**

Art-Nr./No d'article	Grösse/grandeur	Preis/prix
650-352911	7,5 L / 35 x 29 x H 10,5 cm	205.75

**HOELLER «AluChef»
Bräter aus Aluminium
Cocotte en alu**

Aluminium, geeignet für Backofen, Herd, Induktion oder Backofen mit Grillfunktion. *alu, passe au four, sur les plaques de cuisson, y compris à induction, et même sous le grill.*

**Rund
Ronde**

Art-Nr./No d'article	Grösse/grandeur	Preis/prix
650-200011G	2,43 L / Ø 20 x H 8,3 cm	117.40
650-240011G	4,26 L / Ø 24 x H 10,2 cm	152.70
650-280011G	6,8 L / Ø 28 x H 12 cm	187.90

**Oval
Ovale**

Art-Nr./No d'article	Grösse/grandeur	Preis/prix
650-352911G	7,5 L / 35 x 29 x H 10,5 cm	205.75



**HOELLER «AluChef»
Bräter aus Aluminium mit Glasdeckel
Cocotte en alu avec couvercle en verre**

Aluminium, geeignet für Backofen, Herd, Induktion oder Backofen mit Grillfunktion. *alu, passe au four, sur les plaques de cuisson, y compris à induction, et même sous le gril.*

Art-Nr./No d'article Grösse/grandeur Preis/prix
650-320004 5,7 L / Ø 32 x H 7,8 cm **144.65**



**HOELLER «AluChef»
Bräter aus Aluminium mit Glasdeckel
Cocotte en alu avec couvercle en verre**

Aluminium, geeignet für Backofen, Herd, Induktion oder Backofen mit Grillfunktion. *alu, passe au four, sur les plaques de cuisson, y compris à induction, et même sous le gril.*

Art-Nr./No d'article Grösse/grandeur Preis/prix
650-320011G 5,7 L / Ø 32 x H 7,8 cm **144.65**
650-400011G 9,75 L / Ø 40 x H 8,5 cm **198.75**



**HOELLER «AluChef»
Bräter aus Aluminium mit Glasdeckel
Cocotte en alu avec couvercle en verre**

Aluminium, geeignet für Backofen, Herd, Induktion oder Backofen mit Grillfunktion. *alu, passe au four, sur les plaques de cuisson, y compris à induction, et même sous le gril.*

Art-Nr./No d'article Grösse/grandeur Preis/prix
650-282812 4,93 L / 28x28 x H 7,5 cm **132.90**



**HOELLER «AluChef»
Bräter aus Aluminium mit Glasdeckel
Cocotte en alu avec couvercle en verre**

Aluminium, geeignet für Backofen, Herd, Induktion oder Backofen mit Grillfunktion. *alu, passe au four, sur les plaques de cuisson, y compris à induction, et même sous le gril.*

Art-Nr./No d'article Grösse/grandeur Preis/prix
650-320008 5,7 L / Ø 32 x H 7,8 cm **144.65**



**HOELLER «AluChef»
Bräter aus Aluminium mit Glasdeckel
Cocotte en alu avec couvercle en verre**

Aluminium, geeignet für Backofen, Herd, Induktion oder Backofen mit Grillfunktion. *alu, passe au four, sur les plaques de cuisson, y compris à induction, et même sous le gril.*

Art-Nr./No d'article Grösse/grandeur Preis/prix
650-282804 4,93 L / 28x28 x H 7,5 cm **132.90**



**HOELLER «AluChef»
Bräter aus Aluminium mit Glasdeckel
Cocotte en alu avec couvercle en verre**

Aluminium, geeignet für Backofen, Herd, Induktion oder Backofen mit Grillfunktion. *alu, passe au four, sur les plaques de cuisson, y compris à induction, et même sous le gril.*

Art-Nr./No d'article Grösse/grandeur Preis/prix
650-282811 4,93 L / 28x28 x H 7,5 cm **132.90**



**HOELLER «AluChef»
Bräter aus Aluminium mit Glasdeckel
Cocotte en alu avec couvercle en verre**

Aluminium, geeignet für Backofen, Herd, Induktion oder Backofen mit Grillfunktion. *alu, passe au four, sur les plaques de cuisson, y compris à induction, et même sous le gril.*

Art-Nr./No d'article Grösse/grandeur Preis/prix
650-320011 5,7 L / Ø 32 x H 7,8 cm **144.65**
650-400011 9,75 L / Ø 40 x H 8,5 cm **198.75**



**HOELLER «AluChef»
Bräter aus Aluminium mit Glasdeckel
Cocotte en alu avec couvercle en verre**

Aluminium, geeignet für Backofen, Herd, Induktion oder Backofen mit Grillfunktion. *alu, passe au four, sur les plaques de cuisson, y compris à induction, et même sous le gril.*

Art-Nr./No d'article Grösse/grandeur Preis/prix
650-282808 4,93 L / 28x28 x H 7,5 cm **132.90**



**HOELLER «AluChef»
Bräter aus Aluminium mit Glasdeckel
Cocotte en alu avec couvercle en verre**

Aluminium, geeignet für Backofen, Herd, Induktion oder Backofen mit Grillfunktion. *alu, passe au four, sur les plaques de cuisson, y compris à induction, et même sous le gril.*

Art-Nr./No d'article Grösse/grandeur Preis/prix
650-282811G 4,93 L / 28x28 x H 7,5 cm **132.90**

BRÄTER / COCOTTES

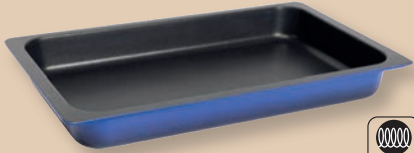
**HOELLER «AluChef»
GN-Pfanne GN 1/1
Plaque à rôtir GN 1/1**

Aluminium, geeignet für Backofen, Herd, Induktion oder Backofen mit Grillfunktion. *alu, passe au four, sur les plaques de cuisson, y compris à induction, et même sous le gril.*

Art-Nr./No d'article Grösse/grandeur Preis/prix
650-5332504 8,5 L / 53x32,5 x H 6,5 cm **233.90**

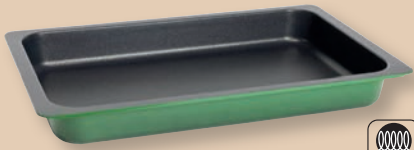
**HOELLER «AluChef»
GN-Pfanne GN 1/1
Plaque à rôtir GN 1/1**

Aluminium, geeignet für Backofen, Herd, Induktion oder Backofen mit Grillfunktion. *alu, passe au four, sur les plaques de cuisson, y compris à induction, et même sous le gril.*

Art-Nr./No d'article Grösse/grandeur Preis/prix
650-5332505 8,5 L / 53x32,5 x H 6,5 cm **233.90**

**HOELLER «AluChef»
GN-Pfanne GN 1/1
Plaque à rôtir GN 1/1**

Aluminium, geeignet für Backofen, Herd, Induktion oder Backofen mit Grillfunktion. *alu, passe au four, sur les plaques de cuisson, y compris à induction, et même sous le gril.*

Art-Nr./No d'article Grösse/grandeur Preis/prix
650-5332508 8,5 L / 53x32,5 x H 6,5 cm **233.90**

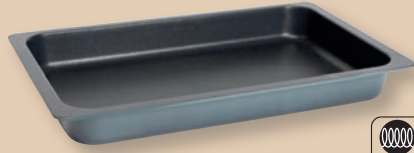
**HOELLER «AluChef»
GN-Pfanne GN 1/1
Plaque à rôtir GN 1/1**

Aluminium, geeignet für Backofen, Herd, Induktion oder Backofen mit Grillfunktion. *alu, passe au four, sur les plaques de cuisson, y compris à induction, et même sous le gril.*

Art-Nr./No d'article Grösse/grandeur Preis/prix
650-5332511 8,5 L / 53x32,5 x H 6,5 cm **233.90**

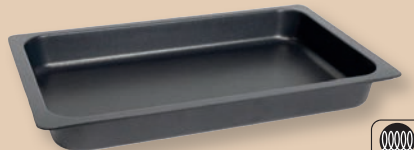
**HOELLER «AluChef»
GN-Pfanne GN 1/1
Plaque à rôtir GN 1/1**

Aluminium, geeignet für Backofen, Herd, Induktion oder Backofen mit Grillfunktion. *alu, passe au four, sur les plaques de cuisson, y compris à induction, et même sous le gril.*

Art-Nr./No d'article Grösse/grandeur Preis/prix
650-5332512 8,5 L / 53x32,5 x H 6,5 cm **233.90**



**HOELLER «AluChef»
Deckel für GN-Pfanne GN 1/1
Couvercle pour plaque à rôtir GN 1/1**
transparentes, hitzebeständiges Glas, schwarze Silikonkanten, mit Silikongriff
verre transparent résistant à la chaleur, bords en silicone noir, avec poignée en silicone

Art-Nr./No d'article Grösse/grandeur Preis/prix
650-53325D 49 x 29 cm **89.20**

**AMT
GN-Pfanne mit Griff
Poêle GN avec anse**

INDUKTIONSGEEIGNET. Mit Beschichtung
INDUCTION. Avec revêtement anti-adhésif

Art-Nr./No d'article Grösse/grandeur Preis/prix
8270.27001 GN 1/1 - H 100 mm **411.70**
8270.27002 GN 2/3 - H 100 mm **343.50**
8270.27003 GN 2/4 - H 55 mm **282.30**



**Bräter mit Fallgriffen
Plaque à rôtir avec poignées tournantes**
Inox 18/10, Schwere Ausführung
Inox 18/10, qualité lourde

Art-Nr./No d'article Grösse/grandeur Preis/prix
8006.04000 42 x 26 cm x H 9 cm **249.35**
8006.04001 50 x 30 cm x H 9 cm **336.40**
8006.04002 60 x 35 cm x H 9 cm **378.80**



**Deckel für Bräter
Couvercle pour plaques à rôtir**
Inox 18/10
Inox 18/10

Art-Nr./No d'article Grösse/grandeur Preis/prix
8006.04003 40 x 26 cm **86.90**
8006.04004 50 x 30 cm **136.50**
8006.04005 60 x 35 cm **161.15**



KOCHTÖPFE / CASSEROLES



**NOSER «Swiss Hotel»
Fleischtopf hoch
Casserole haute**

Inox 18/10, für Induktionskochherde geeignet,
10 Jahre Garantie
Inox 18/10, utilisable aussi sur fourneaux à induction, 10 ans de garantie

Art-Nr./No d'article	Grösse/grandeur	Inhalt /capacité	Preis/prix
8006.01100	Ø 18 x H 13 cm	3 L	152.90
8006.01101	Ø 20 x H 14 cm	4 L	178.80
8006.01102	Ø 22 x H 15 cm	5 L	206.95
8006.01103	Ø 24 x H 16 cm	6,5 L	254.05
8006.01104	Ø 26 x H 17 cm	8 L	343.50
8006.01105	Ø 30 x H 19 cm	12 L	435.25



**NOSER «Hotel»
Fleischtopf hoch
Casserole haute**

höchstwertige Qualität aus Inox 18/10,
induktionsfähig, 10 Jahre Garantie
qualité exceptionnelle en inox 18/10, utilisable aussi pour induction, 10 ans de garantie

Art-Nr./No d'article	Grösse/grandeur	Inhalt /capacité	Preis/prix
8006.02100	Ø 16 x H 11 cm	2 L	163.50
8006.02101	Ø 18 x H 12,5 cm	3 L	206.95
8006.02102	Ø 20 x H 13,5 cm	4 L	254.05
8006.02103	Ø 22 x H 14 cm	5 L	305.85
8006.02104	Ø 24 x H 16 cm	6 L	343.50
8006.02105	Ø 26 x H 16,5 cm	8 L	411.70
8006.02106	Ø 28 x H 18 cm	11 L	505.70
8006.02107	Ø 30 x H 19 cm	12,5 L	541.15
8006.02108	Ø 32 x H 20 cm	15 L	635.25
8006.02109	Ø 36 x H 22 cm	21 L	894.05
8006.02110	Ø 40 x H 25 cm	29,5 L	1023.45
8006.02111	Ø 44 x H 26 cm	38 L	1046.95



**NOSER «Swiss Hotel»
Kochtopf-Bouillonkessel
Marmite à bouillon**

Inox 18/10, für Induktionskochherde geeignet,
10 Jahre Garantie
Inox 18/10, utilisable aussi sur fourneaux à induction, 10 ans de garantie

Art-Nr./No d'article	Grösse/grandeur	Inhalt /capacité	Preis/prix
8006.01000	Ø 20 x H 19 cm	5,5 L	218.80
8006.01001	Ø 22 x H 21 cm	7 L	254.05
8006.01002	Ø 24 x H 23 cm	9 L	305.85
8006.01003	Ø 26 x H 26 cm	12 L	411.70
8006.01004	Ø 30 x H 31 cm	20 L	541.15



**NOSER «Hotel»
Kochtopf-Bouillonkessel
Marmite à bouillon**

höchstwertige Qualität aus Inox 18/10,
induktionsfähig, 10 Jahre Garantie
qualité exceptionnelle en inox 18/10, utilisable aussi pour induction, 10 ans de garantie

Art-Nr./No d'article	Grösse/grandeur	Inhalt /capacité	Preis/prix
8006.02001	Ø 22 x H 19 cm	7 L	343.50
8006.02002	Ø 24 x H 22 cm	9 L	411.70
8006.02003	Ø 26 x H 26 cm	12 L	458.60
8006.02004	Ø 28 x H 28 cm	17 L	587.00
8006.02005	Ø 30 x H 31 cm	20 L	635.25
8006.02006	Ø 32 x H 33 cm	25 L	764.65
8006.02007	Ø 36 x H 37 cm	35 L	998.80
8006.02008	Ø 40 x H 41 cm	48 L	1046.95
8006.02009	Ø 44 x H 45 cm	65 L	1352.90



**NOSER «Gusto»
Fleischtopf hoch
Casserole haute**

Art-Nr./No d'article	Grösse/grandeur	Inhalt /capacité	Preis/prix
8006.02115	Ø 24 x H 14,5 cm	6,5 L	305.85
8006.02116	Ø 28 x H 16,5 cm	10 L	378.80
8006.02117	Ø 32 x H 20,0 cm	16 L	505.70

KOCHTÖPFE / CASSEROLES

**NOSER «Swiss Hotel»
Griffkasserolle nieder
Casserole basse**

Inox 18/10, für Induktionskochherde geeignet,
10 Jahre Garantie
Inox 18/10, utilisable aussi sur fourneaux à induction, 10 ans de garantie

Art-Nr./No d'article	Grösse/grandeur	Inhalt/capacité	Preis/prix
8006.01200	Ø 24 x H 11,5 cm	5 L	254.05
8006.01201	Ø 26 x H 12,5 cm	6,5 L	324.65
8006.01202	Ø 30 x H 13 cm	7,5 L	378.80

**NOSER «Hotel»
Griffkasserolle nieder
Casserole basse**

höchstwertige Qualität aus Inox 18/10,
induktionsfähig, 10 Jahre Garantie
qualité exceptionnelle en inox 18/10, utilisable aussi pour induction, 10 ans de garantie

Art-Nr./No d'article	Grösse/grandeur	Inhalt/capacité	Preis/prix
8006.02206	Ø 16 x H 8,5 cm	1 L	136.50
8006.02207	Ø 18 x H 8,5 cm	1,5 L	206.95
8006.02208	Ø 20 x H 8,5 cm	2,25 L	254.05
8006.02209	Ø 22 x H 8,5 cm	3 L	305.85
8006.02210	Ø 24 x H 10 cm	4 L	343.50
8006.02200	Ø 26 x H 10,5 cm	5 L	411.70
8006.02201	Ø 28 x H 11 cm	6,25 L	435.25
8006.02202	Ø 30 x H 12 cm	7,5 L	505.70
8006.02203	Ø 32 x H 13 cm	9,5 L	587.00
8006.02204	Ø 36 x H 14,5 cm	13,5 L	822.30
8006.02205	Ø 40 x H 16 cm	18,5 L	894.05

**NOSER «Gusto»
Griffkasserolle nieder
Casserole basse**

Art-Nr./No d'article	Grösse/grandeur	Inhalt/capacité	Preis/prix
8006.02730	Ø 24 x H 9,5 cm	4,25 L	206.95
8006.02731	Ø 28 x H 10,5 cm	6,5 L	254.05
8006.02732	Ø 32 x H 12,5 cm	10 L	324.65

Passende Deckel auf der
nachfolgenden Seite.

Couvercles correspondants
à la page suivante.

**NOSER «Swiss Hotel»
Stielkasserolle hoch
Casserole à manche haute**

Inox 18/10, für Induktionskochherde geeignet,
10 Jahre Garantie
Inox 18/10, utilisable aussi sur fourneaux à induction, 10 ans de garantie

Art-Nr./No d'article	Grösse/grandeur	Inhalt/capacité	Preis/prix
8006.01300	Ø 18 x H 13 cm	3 L	163.50
8006.01301	Ø 20 x H 14 cm	4 L	178.80
8006.01302	Ø 22 x H 15 cm	5 L	218.80
8006.01303	Ø 24 x H 16 cm	6,5 L	254.05
8006.01304*	Ø 26 x H 17 cm	8 L	343.50
8006.01305*	Ø 30 x H 19 cm	12 L	435.25

*mit Gegengriff/avec poignée supplémentaire

**NOSER «Hotel»
Stielkasserolle hoch
Casserole à manche haute**

höchstwertige Qualität aus Inox 18/10,
induktionsfähig, 10 Jahre Garantie
qualité exceptionnelle en inox 18/10, utilisable aussi pour induction, 10 ans de garantie

Art-Nr./No d'article	Grösse/grandeur	Inhalt/capacité	Preis/prix
8006.02300	Ø 16 x H 11 cm	2 L	191.70
8006.02301	Ø 18 x H 12,5 cm	3 L	230.50
8006.02302	Ø 20 x H 13,5 cm	4 L	282.30
8006.02303	Ø 22 x H 14,5 cm	5 L	324.65
8006.02304	Ø 24 x H 15,5 cm	6 L	378.80
8006.02305*	Ø 26 x H 16,5 cm	8 L	458.60
8006.02306*	Ø 28 x H 18 cm	11 L	541.15
8006.02307*	Ø 30 x H 19 cm	12,5 L	635.25
8006.02308*	Ø 32 x H 20 cm	15 L	764.65
8006.02309*	Ø 36 x H 22 cm	21 L	894.05
8006.02310*	Ø 40 x H 25 cm	29,5 L	1046.95
8006.02311*	Ø 44 x H 26 cm	38 L	1173.95

*mit Gegengriff/avec poignée supplémentaire

**NOSER «Gusto»
Stielkasserolle hoch
Casserole à manche haute**

Art-Nr./No d'article	Grösse/grandeur	Inhalt/capacité	Preis/prix
8006.02740	Ø 16 x H 10,5 cm	2,0 L	163.50
8006.02741	Ø 18 x H 12,0 cm	3,0 L	191.70
8006.02742	Ø 20 x H 13,0 cm	4,0 L	218.80
8006.02747	Ø 22 x H 13,5 cm	5,0 L	254.05

**NOSER «Swiss Hotel»
Stielkasserolle nieder
Casserole à manche basse**

Inox 18/10, für Induktionskochherde geeignet,
10 Jahre Garantie
Inox 18/10, utilisable aussi sur fourneaux à induction, 10 ans de garantie

Art-Nr./No d'article	Grösse/grandeur	Inhalt/capacité	Preis/prix
8006.01400	Ø 18 x H 9 cm	2 L	152.90
8006.01401	Ø 20 x H 9,5 cm	2,5 L	163.50
8006.01402	Ø 22 x H 10,5 cm	3,5 L	206.95
8006.01403	Ø 24 x H 11,5 cm	5 L	254.05
8006.01404*	Ø 26 x H 12,5 cm	6,5 L	343.50
8006.01405*	Ø 30 x H 13 cm	7,5 L	411.70

*mit Gegengriff/avec poignée supplémentaire

**NOSER «Hotel»
Stielkasserolle nieder
Casserole à manche basse**

höchstwertige Qualität aus Inox 18/10,
induktionsfähig, 10 Jahre Garantie
qualité exceptionnelle en inox 18/10, utilisable aussi pour induction, 10 ans de garantie

Art-Nr./No d'article	Grösse/grandeur	Inhalt/capacité	Preis/prix
8006.02400	Ø 16 x H 8,5 cm	1 L	191.70
8006.02401	Ø 18 x H 8,5 cm	1,5 L	230.50
8006.02402	Ø 20 x H 8,5 cm	2,25 L	282.50
8006.02403	Ø 22 x H 8,5 cm	3 L	324.65
8006.02404	Ø 24 x H 10 cm	4 L	378.80
8006.02405*	Ø 26 x H 10,5 cm	5 L	435.25
8006.02406*	Ø 28 x H 11 cm	6,25 L	505.70
8006.02407*	Ø 30 x H 12 cm	7,5 L	541.15
8006.02408*	Ø 32 x H 13 cm	9,5 L	635.25
8006.02409*	Ø 36 x H 14,5 cm	13,5 L	822.30
8006.02410*	Ø 40 x H 16 cm	18,5 L	894.05

*mit Gegengriff/avec poignée supplémentaire

**NOSER «Gusto»
Stielkasserolle nieder
Casserole à manche basse**

Art-Nr./No d'article	Grösse/grandeur	Inhalt/capacité	Preis/prix
8006.02743	Ø 16 x H 8,0 cm	1,5 L	139.90
8006.02744	Ø 18 x H 8,5 cm	2,0 L	152.90
8006.02745	Ø 20 x H 8,5 cm	2,5 L	163.50
8006.02746	Ø 22 x H 9,5 cm	3,25 L	178.80



**NOSER «Standard»
Saucepfännchen
Casserole à sauces**

Art.-Nr./No d'article	Grösse/grandeur	Inhalt / capacité	Preis/prix
8006.02810	Ø 12 x H 7,5 cm	0,6 L	82.10



**NOSER «Standard»
Deckel
Couvercle**

Art.-Nr./No d'article	Grösse/grandeur	Preis/prix
8006.02811	Ø 12 cm	35.15



**NOSER «Standard»
Stielkasserole
Casserole à manche**

Art.-Nr./No d'article	Grösse/grandeur	Inhalt / capacité	Preis/prix
8006.02812	Ø 14 x H 9 cm	1,25 L	99.75
8006.02813	Ø 16 x H 10 cm	1,75 L	117.25



**NOSER «Standard»
Auflagedeckel mit Bügel
Couvercle avec anse**

Art.-Nr./No d'article	Grösse/grandeur	Preis/prix
8006.02814	Ø 14 cm	45.85
8006.02815	Ø 16 cm	46.90



**NOSER
Deckel «Swiss Hotel / Hotel / Gusto»
Couvercle «Swiss Hotel / Hotel / Gusto»**

höchstwertige Qualität aus Inox 18/10,
10 Jahre Garantie
qualité exceptionnelle en inox 18/10, 10 ans de garantie

Art.-Nr./No d'article	Grösse/grandeur	Preis/prix
8006.02700	Ø 16 cm	41.15
8006.02701	Ø 18 cm	43.50
8006.02702	Ø 20 cm	45.85
8006.02703	Ø 22 cm	50.55
8006.02704	Ø 24 cm	61.15
8006.02705	Ø 26 cm	68.20
8006.02706	Ø 28 cm	82.10
8006.02707	Ø 30 cm	86.90
8006.02708	Ø 32 cm	98.55
8006.02709	Ø 36 cm	114.65
8006.02710	Ø 40 cm	139.90
8006.02711	Ø 44 cm	152.90



**NOSER
Mesurentopf
Pot à mesure**

mit 100-g-Einteilung
avec graduation de 100 g

Art.-Nr./No d'article	Grösse/grandeur	Inhalt / capacité	Preis/prix
8006.02819	Ø 11 x H 13 cm	1 L	137.60
8006.02820	Ø 14 x H 16 cm	2 L	152.90



**NOSER
Milchtopf
Pot à lait**

INDUKTIONSGEEIGNET. Mit Mehrschicht-Wärmeleitbiden und 100-g-Einteilung
INDUCTION. Avec fond à conduction thermique à graduation de 100 g

Art.-Nr./No d'article	Grösse/grandeur	Inhalt / capacité	Preis/prix
8006.02821	Ø 11 x H 13,5 cm	1 L	173.95
8006.02822	Ø 14 x H 16,5 cm	2 L	188.20



**Simmertopf
Casserole**

Inox 18/10, mit Kompensboden, induktionsgeeignet, mit Deckel, Messstab und Einfülltrichter. Zum Zubereiten von Saucen und Milchspeisen ohne Anhaften und Überkochen der Speisen.
Acier inoxydable 18/10, avec fond compensé, induction, avec couvercle, jalon et entonnoir. Pour la préparation de sauces et mets au lait, anti-adhérent et anti-déborçant.

Art.-Nr./No d'article	Grösse/grandeur	Inhalt / capacité	Preis/prix
8006.42305	Ø 18 x H 14 cm	3 L	211.55
8006.42306	Ø 24 x H 18 cm	6 L	294.05



**Nudelkocher-Einsatz
Empiècement à pâtes**

Edelstahl 18/10, schwere Qualität
Inox 18/10, qualité lourde

Art.-Nr./No d'article	Grösse/grandeur	Preis/prix
8006.40600	Ø 20 x H 14,5 cm	76.20
8006.40601	Ø 24 x H 19 cm	81.15
8006.40602	Ø 28 x H 22,5 cm	102.10



**«Easyline»
Teigwaren- und Reiseinsatz 1/4
Empiècement à pâtes et riz ¼**

hochwertige Qualität aus Inox 18/10
qualité en inox 18/10

Art.-Nr./No d'article	Grösse/grandeur	Preis/prix
für Topf / pour casserole 8006.42260		
8006.42303	Ø 36 x H 23 cm	72.65
für Topf / pour casserole 8006.42261		
8006.42304	Ø 40 x H 26 cm	86.90

KOCHTÖPFE / CASSEROLES



BEST PRICE

**«Easyline»
Kochtopf hoch
Marmite haute**

hochwertige Qualität aus Inox 18/10, induktionsfähig
qualité en inox 18/10, utilisable aussi pour induction

Art-Nr./No d'article	Grösse/grandeur	Inhalt/capacité	Preis/prix
8006.42240	Ø 16 x H 16 cm	3 L	64.65
8006.42241	Ø 20 x H 20 cm	6 L	89.35
8006.42242	Ø 24 x H 25 cm	10 L	107.60
8006.42243	Ø 28 x H 27 cm	16 L	139.90
8006.42244	Ø 32 x H 33 cm	25 L	191.70
8006.42245	Ø 36 x H 37 cm	36 L	254.05
8006.42246	Ø 40 x H 41 cm	50 L	324.65
8006.42247	Ø 45 x H 46 cm	70 L	435.25
8006.42248	Ø 50 x H 51 cm	100 L	541.15



BEST PRICE

**«Easyline»
Kochtopf mittelhoch
Marmite demi-haute**

hochwertige Qualität aus Inox 18/10, induktionsfähig
qualité en inox 18/10, utilisable aussi pour induction

Art-Nr./No d'article	Grösse/grandeur	Inhalt/capacité	Preis/prix
8006.42250	Ø 24 x H 21 cm	9 L	98.55
8006.42251	Ø 26 x H 24 cm	12 L	114.65
8006.42252	Ø 30 x H 26 cm	18 L	152.90
8006.42253	Ø 32 x H 27 cm	20 L	178.80
8006.42254	Ø 34 x H 28 cm	24 L	206.95



BEST PRICE

**«Easyline»
Fleischtopf
Casserole**

hochwertige Qualität aus Inox 18/10, induktionsfähig
qualité en inox 18/10, utilisable aussi pour induction

Art-Nr./No d'article	Grösse/grandeur	Inhalt/capacité	Preis/prix
8006.42255	Ø 16 x H 13 cm	2,5 L	45.85
8006.42256	Ø 20 x H 15 cm	4 L	64.65
8006.42257	Ø 24 x H 17 cm	7 L	86.90
8006.42258	Ø 28 x H 19 cm	10 L	107.60
8006.42259	Ø 32 x H 21 cm	15 L	148.20
8006.42260	Ø 36 x H 23 cm	22 L	178.80
8006.42261	Ø 40 x H 26 cm	28 L	249.35
8006.42262	Ø 45 x H 29 cm	44 L	324.65
8006.42263	Ø 50 x H 33 cm	60 L	411.70



BEST PRICE

**«Easyline»
Bratentopf nieder
Casserole basse**

hochwertige Qualität aus Inox 18/10, induktionsfähig
qualité en inox 18/10, utilisable aussi pour induction

Art-Nr./No d'article	Grösse/grandeur	Inhalt/capacité	Preis/prix
8006.42265	Ø 16 x H 8 cm	1,5 L	38.80
8006.42266	Ø 20 x H 11 cm	3,5 L	58.80
8006.42267	Ø 24 x H 12 cm	5 L	76.20
8006.42268	Ø 28 x H 14 cm	8 L	93.75
8006.42269	Ø 32 x H 17 cm	12 L	123.50
8006.42270	Ø 36 x H 12 cm	10 L	148.20
8006.42271	Ø 40 x H 14 cm	15 L	206.95
8006.42272	Ø 45 x H 15 cm	20 L	254.05
8006.42273	Ø 50 x H 20,5 cm	38 L	343.50



BEST PRICE

**«Easyline»
Stielkasserolle hoch
Casserole à manche haute**

hochwertige Qualität aus Inox 18/10, induktionsfähig
qualité en inox 18/10, utilisable aussi pour induction

Art-Nr./No d'article	Grösse/grandeur	Inhalt/capacité	Preis/prix
8006.42274	Ø 16 x H 13 cm	2,5 L	42.30
8006.42275	Ø 18 x H 13 cm	3,25 L	50.55
8006.42276	Ø 20 x H 15 cm	4 L	61.15
8006.42277	Ø 24 x H 17 cm	7 L	82.10



BEST PRICE

**«Easyline»
Stielkasserolle nieder
Casserole à manche basse**

hochwertige Qualität aus Inox 18/10, induktionsfähig
qualité en inox 18/10, utilisable aussi pour induction

Art-Nr./No d'article	Grösse/grandeur	Inhalt/capacité	Preis/prix
8006.42278	Ø 16 x H 10 cm	1,5 L	39.95
8006.42279	Ø 18 x H 10 cm	2,5 L	44.65
8006.42280	Ø 20 x H 11 cm	3 L	56.40
8006.42281	Ø 24 x H 12 cm	5 L	72.65



BEST PRICE

**«Easyline»
Deckel
Couvercle**

hochwertige Qualität aus Inox 18/10
qualité en inox 18/10

Art-Nr./No d'article	Grösse/grandeur	Preis/prix
8006.42290	Ø 16 cm	12.70
8006.42291	Ø 18 cm	14.55
8006.42292	Ø 20 cm	16.40
8006.42293	Ø 24 cm	21.15
8006.42294	Ø 26 cm	26.55
8006.42295	Ø 28 cm	29.35
8006.42296	Ø 30 cm	36.95
8006.42297	Ø 32 cm	41.15
8006.42298	Ø 34 cm	45.85
8006.42299	Ø 36 cm	51.70
8006.42300	Ø 40 cm	68.20
8006.42301	Ø 45 cm	81.15
8006.42302	Ø 50 cm	107.60

PFANNEN / POÊLES



NOSER «Swiss Hotel» Sauteuse Sauteuse

INDUKTIONSGEEIGNET. Inox 18/10, bordierter Rand, mehrschichtig
INDUCTION. Inox 18/10, bordé, plusieurs couches

Art-Nr./No d'article	Grösse/grandeur	Preis/prix
8006.01500	1,5 L / Ø 18 cm	206.95
8006.01501	1,8 L / Ø 20 cm	218.80
8006.01502	3,0 L / Ø 24 cm	254.05
8006.01503	4,0 L / Ø 26 cm	270.30



NOSER «Hotel» Sauteuse Sauteuse

INDUKTIONSGEEIGNET. Inox 18/10, mit Schüttrand
INDUCTION. Inox 18/10, bord verseur

Art-Nr./No d'article	Grösse/grandeur	Preis/prix
8006.02500	1,5 L / Ø 18 cm	254.05
8006.02501	1,8 L / Ø 20 cm	282.30
8006.02502	3,0 L / Ø 24 cm	324.65
8006.02503	4,0 L / Ø 26 cm	378.80



NOSER «Swiss Hotel» Sauteuse Sauteuse

INDUKTIONSGEEIGNET. Inox 18/10, bordierter Rand, mehrschichtig
INDUCTION. Inox 18/10, bordé, plusieurs couches

Art-Nr./No d'article	Grösse/grandeur	Preis/prix
8006.01504	5,0 L / Ø 32 cm	411.70



NOSER «Futura» Saucenpfännchen Casserole à sauces

Art-Nr./No d'article	Grösse/grandeur	Inhalt / capacité	Preis/prix
8006.01605	Ø 11 x H 5,5 cm	0,4 L	76.20



NOSER «Gusto» Sauteuse Sauteuse

INDUKTIONSGEEIGNET. Inox 18/10, mehrschichtig mit Aluminiumkern
INDUCTION. Inox 18/10, multi-couche avec noyau en aluminium

Art-Nr./No d'article	Grösse/grandeur	Preis/prix
8006.02749	0,7 L / Ø 14 x H 5,5 cm	139.90
8006.02750	1,0 L / Ø 16 x H 6,5 cm	148.20
8006.02751	1,3 L / Ø 18 x H 6,5 cm	163.50
8006.02752	1,5 L / Ø 20 x H 7,5 cm	178.80
8006.02753	2,75 L / Ø 24 x H 8,5 cm	206.95
8006.02754	3,5 L / Ø 26 x H 9,5 cm	218.80



NOSER «Gusto» Sauteuse Sauteuse

INDUKTIONSGEEIGNET. Inox 18/10, mehrschichtig mit Aluminiumkern, mit Antihafbeschichtung
INDUCTION. Inox 18/10, multi-couche avec noyau en aluminium, avec revêtement anti-adhésif

Art-Nr./No d'article	Grösse/grandeur	Preis/prix
8006.02760	0,7 L / Ø 14 x H 5,5 cm	152.90
8006.02761	1,0 L / Ø 16 x H 6,5 cm	163.50
8006.02762	1,3 L / Ø 18 x H 7,0 cm	178.80
8006.02763	1,5 L / Ø 20 x H 7,5 cm	206.95
8006.02764	2,75 L / Ø 24 x H 8,5 cm	254.05
8006.02765	3,5 L / Ø 26 x H 9,0 cm	282.30



«Multi-Metal» Sauteuse Sauteuse

INDUKTIONSGEEIGNET
INDUCTION

Art-Nr./No d'article	Grösse/grandeur	Inhalt/Capacité	Preis/prix
8006.20060*	Ø 12 cm	0,5 L	44.65
8006.20061*	Ø 14 cm	0,7 L	49.35
8006.20062	Ø 16 cm	1,0 L	57.60
8006.20063	Ø 18 cm	1,2 L	66.95
8006.20064	Ø 20 cm	1,7 L	73.85
8006.20065	Ø 24 cm	2,9 L	102.10

*Drahtgriff/Manche fil métallique

PFANNEN / POÊLES

**SPRING****Sauteuse****Sauteuse**

INDUKTIONSGEEIGNET. Inox 18/10, bordierter Rand, Mehrschichtig

INDUCTION. *Inox 18/10, bordé, plusieurs couche*

Art-Nr./No d'article	Grösse/grandeur	Preis/prix
8006.20403	1,1 L / Ø 16 x H 6,0 cm	103.15
8006.20404	1,5 L / Ø 18 x H 6,5 cm	113.50
8006.20405	2,0 L / Ø 20 x H 7,0 cm	134.05
8006.20406	3,4 L / Ø 24 x H 8,5 cm	148.20

**NOSER «Hotel»****Bratpfanne****Poêle a frire**

INDUKTIONSGEEIGNET. Inox 18/10, mit Schüttrand

INDUCTION. *Inox 18/10, bord verseur*

Art-Nr./No d'article	Grösse/grandeur	Preis/prix
8006.02510	Ø 15/20 cm	163.50
8006.02511	Ø 18/24 cm	206.95
8006.02512	Ø 20/28 cm	254.05

**NOSER «Hotel»****Bratpfanne****Poêle a frire**

INDUKTIONSGEEIGNET. Inox 18/10, mit Schüttrand

INDUCTION. *Inox 18/10, bord verseur*

Art-Nr./No d'article	Grösse/grandeur	Preis/prix
8006.02513	Ø 24/32 cm	378.80
8006.02514	Ø 30/36 cm	541.15
8006.02515	Ø 32/40 cm	694.00

**NOSER «Titan»****Bratpfanne****Poêle a frire**

INDUKTIONSGEEIGNET. Inox 18/10, widerstandsfähige Spezialbeschichtung

INDUCTION. *Inox 18/10, revêtement spécial très résistant*

Art-Nr./No d'article	Grösse/grandeur	Preis/prix
8006.02020	Ø 15/20 cm x H 4 cm	191.70
8006.02021	Ø 18/24 cm x H 5,5 cm	254.05
8006.02022	Ø 20/28 cm x H 5,5 cm	305.85
8006.02023	Ø 24/32 cm x H 6,5 cm	435.25

**NOSER «Titan»****Bratpfanne****Poêle a frire**

INDUKTIONSGEEIGNET. Inox 18/10, widerstandsfähige Spezialbeschichtung

INDUCTION. *Inox 18/10, revêtement spécial très résistant*

Art-Nr./No d'article	Grösse/grandeur	Preis/prix
8006.02025	Ø 20 cm x H 3,5 cm	152.90
8006.02026	Ø 24 cm x H 4 cm	191.70
8006.02027	Ø 26 cm x H 4 cm	206.95

**NOSER «Induct Control»****Bratpfanne****Poêle a frire**

INDUKTIONSGEEIGNET. Controlinduc Material verhindert ein Überhitzen auf über 250° C auf Induktionsherden. Bei 250° C verliert die Pfanne den Magnetismus, sodass sie auf Induktionsherden nicht weiter erhitzt wird.

INDUCTION. *Le matériau «Controlinduc» empêche la surchauffe dès 250° C sur les cuisinières à induction. A 250° C, la poêle perd son magnétisme, ce qui empêche la plaque de surchauffer.*

Art-Nr./No d'article	Grösse/grandeur	Preis/prix
8006.02040	Ø 15/20 cm x H 4 cm	254.05
8006.02041	Ø 18/24 cm x H 5,5 cm	324.65
8006.02042	Ø 20/28 cm x H 5,5 cm	411.70
8006.02043	Ø 24/32 cm x H 6,5 cm	587.00

**NOSER «Induct Control»****Bratpfanne hoch****Poêle a frire haut**

INDUKTIONSGEEIGNET. Controlinduc Material verhindert ein Überhitzen auf über 250° C auf Induktionsherden. Bei 250° C verliert die Pfanne den Magnetismus, sodass sie auf Induktionsherden nicht weiter erhitzt wird.

INDUCTION. *Le matériau «Controlinduc» empêche la surchauffe dès 250° C sur les cuisinières à induction. A 250° C, la poêle perd son magnétisme, ce qui empêche la plaque de surchauffer.*

Art-Nr./No d'article	Grösse/grandeur	Preis/prix
8006.02044	Ø 18/24 cm x H 7 cm	351.70
8006.02045	Ø 20/28 cm x H 9 cm	458.60

**NOSER «Titan»****Röstipfännchen****Poêle à Rösti**

INDUKTIONSGEEIGNET. Eisenblech, widerstandsfähige Spezialbeschichtung

INDUCTION. *Tôle de fer, revêtement spécial très résistant*

Art-Nr./No d'article	Grösse/grandeur	Preis/prix
8006.02030	Ø 18 cm x H 3,5 cm	139.90

**NOSER «Titan»****Röstipfanne****Poêle à Rösti**

INDUKTIONSGEEIGNET. Eisenblech, widerstandsfähige Spezialbeschichtung

INDUCTION. *Tôle de fer, revêtement spécial très résistant*

Art-Nr./No d'article	Grösse/grandeur	Preis/prix
8006.02817	Ø 24 x H 5 cm	161.15
8006.02818	Ø 28 x H 5,3 cm	181.15



**NOSER «Titan»
Mini-WOK**

INDUKTIONSGEEIGNET. Eisenblech, widerstandsfähige Spezialbeschichtung INDUCTION. Tôle de fer, revêtement spécial très résistant

Art-Nr./No d'article	Grösse/grandeur	Inhalt / capacité	Preis/prix
8006.02816	Ø 14 x H 4 cm	0,475 L	123.50



**«Cellresist»
Bratpfanne**

Poêle à frire
INDUKTIONSGEEIGNET. Hochwertiger rostfreier Edelstahl, Edelstahl-Wabennetz schützt vor verkratzen, strapazierfähige Antihaft-Beschichtung INDUCTION. Acier inoxydable de haute qualité, structure alvéolée en acier inoxydable anti-rayure, revêtement anti-adhésif et robuste

Art-Nr./No d'article	Grösse/grandeur	Preis/prix
540-1000.01	Ø 24 cm	55.25
540-1001.01	Ø 28 cm	76.20
540-1002.01	Ø 30 cm	87.00



Bratpfanne mit Antihafbeschichtung

Poêle avec revêtement anti-adhésif
INDUKTIONSGEEIGNET. Hochwertige Aluminium-Qualität, XXStrong-ceramic-Antihaft-Versiegelung, Heat-Control-Induktionsboden: Schützt die Pfanne vor Überhitzung bei Benutzung auf modernen Induktionskochfeldern durch Drosselung der Wärmeaufnahme ab einer Brattemperatur von 200° C. Unterbricht bei Pfannenhitze über 240°C. INDUCTION. Aluminium de haute qualité, scellement en céramique anti-adhésif XXStrong, Fond pour induction avec contrôle de la chaleur : empêche la poêle de surchauffer lors d'une utilisation sur des plaques à induction modernes grâce à la limitation de l'apport en chaleur à partir d'une température de 200 °C.

Art-Nr./No d'article	Grösse/grandeur	Preis/prix
8006.20070	Ø 24 cm	161.15
8006.20071	Ø 28 cm	185.85

**MIT ÜBERHITZUNGSSCHUTZ
PROTECTION CONTRE
LA SURCHAUFFE**



BEST-SELLER

**«Industar»
Bratpfanne**

Poêle à frire
INDUKTIONSGEEIGNET. Hochwertiger Edelstahl rostfrei INDUCTION. Acier inoxydable de grande qualité

Art-Nr./No d'article	Grösse/grandeur	Preis/prix
8006.20050	Ø 20 cm	52.90
8006.20051	Ø 24 cm	74.95
8006.20052	Ø 28 cm	92.80
8006.20053	Ø 32 cm	109.85



Ecoglide-Bratpfanne

Poêle à frire Ecoglide
INDUKTIONSGEEIGNET. Inox 18/10, Ecoglide-Beschichtung INDUCTION. inox 18/10, revêtement Ecoglide

Art-Nr./No d'article	Grösse/grandeur	Preis/prix
8006.20500	Ø 20 cm x H 4,5 cm	81.15
8006.20501	Ø 24 cm x H 5,0 cm	103.15
8006.20502	Ø 26 cm x H 5,5 cm	117.25
8006.20503	Ø 28 cm x H 5,5 cm	148.20
8006.20504	Ø 32 cm x H 6,5 cm	171.70



Bratpfanne mit Antihafbeschichtung

Poêle avec revêtement anti-adhésif
Nicht induktionsgeeignet, aus Aluminium extra-stark, 4-schichtig Pas d'induction, en aluminium extra-fort, 4 couches

Art-Nr./No d'article	Grösse/grandeur	Preis/prix
8006.05640	Ø 20 x H 4 cm	44.65
8006.05641	Ø 24 x H 4 cm	50.55
8006.05642	Ø 28 x H 4 cm	57.60
8006.05643	Ø 32 x H 4 cm	70.55
8006.05644	Ø 36 x H 5 cm	96.20
8006.05645	Ø 40 x H 5 cm	107.60



Fischpfanne oval

Poêle à poisson ovale
INDUKTIONSGEEIGNET. Aluminiumguss (handgegossen), Antihafbeschichtung, Stiel aus Edelstahl 18/10, backofenfest bis +250°C INDUCTION. Aluminium moulé (coulé à la main), revêtement anti-adhésif, manche en acier inoxydable 18/10, compatible four jusqu'à +250 °C.

Art-Nr./No d'article	Grösse/grandeur	Preis/prix
8006.40445	38 x 26 cm x H 6 cm	298.85



**SPRING «Vulcano Mini Line»
Mini-Pfännchen**

Poêle à frire miniature
INDUKTIONSGEEIGNET. Aluminium, 3-fach Antihafversiegelung INDUCTION. Aluminium, triple revêtement anti-adhésif

Art-Nr./No d'article	Grösse/grandeur	Preis/prix
8006.20208	Ø 16 cm x H 3,6 cm	31.70
8006.20209	Ø 18 cm x H 4,0 cm	35.15



Wok mit Boden rund

Wok avec fond bombé
INDUKTIONSGEEIGNET. Aus Mehrschichtmaterial INDUCTION. En matériau multicouches

Art-Nr./No d'article	Grösse/grandeur	Preis/prix
8006.42307	Ø 36 cm	188.20



Wok mit Boden flach

Wok avec fond plat
INDUKTIONSGEEIGNET. Aus Mehrschichtmaterial INDUCTION. En matériau multicouches

Art-Nr./No d'article	Grösse/grandeur	Preis/prix
8006.42308	Ø 36 cm	173.95

PFANNEN / POÊLES

**SPRING «Culinox»
Bratpfanne
Poêle à frire**

INDUKTIONSGEEIGNET. 5-Lagen Mehrschichtmaterial mit echter Kupferlage.
INDUCTION. 5 couches différentes de matériaux avec couche en cuivre véritable.

Art-Nr./No d'article	Grösse/grandeur	Preis/prix
8006.20301	Ø 24 cm x H 5,2 cm	198.95
8006.20302	Ø 28 cm x H 4,9 cm	234.05

**SPRING «Culinox»
Stielkasserolle nieder mit Deckel
Casserole à manche bas avec couvercle**

INDUKTIONSGEEIGNET. 5-Lagen Mehrschichtmaterial mit echter Kupferlage.
INDUCTION. 5 couches différentes de matériaux avec couche en cuivre véritable.

Art-Nr./No d'article	Grösse/grandeur	Preis/prix
8006.20303	1,4 L / Ø 16 x H 7,5 cm	218.80

**SPRING «Culinox»
Stielkasserolle hoch mit Deckel
Casserole à manche haut avec couvercle**

INDUKTIONSGEEIGNET. 5-Lagen Mehrschichtmaterial mit echter Kupferlage.
INDUCTION. 5 couches différentes de matériaux avec couche en cuivre véritable.

Art-Nr./No d'article	Grösse/grandeur	Preis/prix
8006.20304	3,7 L / Ø 20 x H 12 cm	294.05

**SPRING «Culinox»
Fleischtopf mit Deckel
Casserole avec couvercle**

INDUKTIONSGEEIGNET. 5-Lagen Mehrschichtmaterial mit echter Kupferlage.
INDUCTION. 5 couches différentes de matériaux avec couche en cuivre véritable.

Art-Nr./No d'article	Grösse/grandeur	Preis/prix
8006.20305	3,7 L / Ø 20 x H 12 cm	294.05
8006.20306	6,5 L / Ø 24 x H 14 cm	336.40

**SPRING «Culinox»
Gourmettopf mit Deckel
Casserole gourmet avec couvercle**

INDUKTIONSGEEIGNET. 5-Lagen Mehrschichtmaterial mit echter Kupferlage.
INDUCTION. 5 couches différentes de matériaux avec couche en cuivre véritable.

Art-Nr./No d'article	Grösse/grandeur	Preis/prix
8006.20307	4 L / Ø 28 x H 7 cm	336.40

**SPRING «Culinox»
Sauteuse
Sauteuse**

INDUKTIONSGEEIGNET. 5-Lagen Mehrschichtmaterial mit echter Kupferlage.
INDUCTION. 5 couches différentes de matériaux avec couche en cuivre véritable.

Art-Nr./No d'article	Grösse/grandeur	Preis/prix
8006.20309	1,5 L / Ø 18 cm	173.95
8006.20308	2 L / Ø 20 x H 7 cm	188.20

**SPRING
Kupfer-Reiniger
Nettoyant pour cuivre**

Kupfer-Reiniger einfach und effizient in der Anwendung für Kupfer und Messing.
Pour cuivre et laiton.

Art-Nr./No d'article	Grösse/grandeur	Preis/prix
8006.20315	250 g	19.95
8006.20316	750 g	28.90

**Kupfer-Flambierpfanne
Poêle à flamber en cuivre**

INDUKTIONSGEEIGNET.
INDUCTION.

Art-Nr./No d'article	Grösse/grandeur	Preis/prix
8006.42309	Ø 24 cm x H 4,5 cm	123.50

**«Ironstar»
Bratpfanne
Poêle à frire**

INDUKTIONSGEEIGNET. Hochwertiges, robustes Eisen
INDUCTION. Fer robuste de qualité supérieure

Art-Nr./No d'article	Grösse/grandeur	Preis/prix
8006.20081	Ø 20 cm	52.90
8006.20082	Ø 24 cm	70.55
8006.20083	Ø 28 cm	86.90
8006.20084*	Ø 30 cm	99.75

*mit Gegengriff/avec poignée supplémentaire

**«Ironstar»
Wokpfanne
Wok**

INDUKTIONSGEEIGNET. Hochwertiges, robustes Eisen
INDUCTION. Fer robuste de qualité supérieure

Art-Nr./No d'article	Grösse/grandeur	Preis/prix
8006.20085	Ø 28 cm	99.75

**NOSER «Black Steel»
Lyonerpfanne
Poêles en acier**

INDUKTIONSGEEIGNET. Aus hochwertigem Carbonstahl, auch im Backofen verwendbar
INDUCTION. En acier au carbone, haute qualité, aussi utilisable à four

Art-Nr./No d'article	Grösse/grandeur	Preis/prix
8006.02770	Ø 20 cm x H 5,2 cm	152.90
8006.02771	Ø 24 cm x H 5,5 cm	178.80
8006.02772	Ø 28 cm x H 6,0 cm	230.50
8006.02773	Ø 32 cm x H 7,0 cm	305.85



**«Black Star»
Eisenpfanne**
Poêles en acier
INDUKTIONSGEEIGNET.
INDUCTION.

Art.-Nr./No d'article	Grösse/grandeur	Preis/prix
8006.21008	Ø 19 cm	130.55
8006.21009	Ø 24 cm	185.85
8006.21010	Ø 28 cm	218.80
8006.21011	Ø 32 cm	254.05
8006.21004	Ø 36 cm	305.85



**«Black Star»
Eisenpfanne mit Seitengriffen**
Poêles en acier avec anses
INDUKTIONSGEEIGNET.
INDUCTION.

Art.-Nr./No d'article	Grösse/grandeur	Preis/prix
8006.21028	Ø 28 cm	254.05
8006.21032	Ø 32 cm	294.05



Crêpes Pfanne
Poêle à crêpes
INDUKTIONSGEEIGNET.
INDUCTION.

Art.-Nr./No d'article	Grösse/grandeur	Preis/prix
8006.21270	Ø 18 cm	15.95
8006.21271	Ø 20 cm	17.95
8006.21272	Ø 22 cm	19.15
8006.21273	Ø 24 cm	21.15



Eisen-Blinispfännchen
Poêlon à blinis en fer
INDUKTIONSGEEIGNET. Schwere Qualität
INDUCTION. Qualité lourde

Art.-Nr./No d'article	Grösse/grandeur	Preis/prix
8006.42312	Ø 12 cm x H 2,5 cm	13.95



Paella-Eisenpfanne
Poêle à paella
INDUKTIONSGEEIGNET. Aus gebläutem Stahl,
schwere Qualität
INDUCTION. En tôle d'acier bleuie, qualité lourde

Art.-Nr./No d'article	Grösse/grandeur	Preis/prix
8006.21280	Ø 34,5 cm x H 5,0 cm	74.95
8006.21282	Ø 42,0 cm x H 5,5 cm	98.55
8006.21283	Ø 47,0 cm x H 6,5 cm	117.25
8006.21284	Ø 60,0 cm x H 6,5 cm	234.05



Grillpfanne gerippt mit Deckel
Poêle à grill en fonte avec couvercle
INDUKTIONSGEEIGNET. Gusseisen emailliert,
mit Rezeptbuch (d/f/i)
INDUCTION. Font d'acier émaillée, avec livre de
recettes (d/f/i)

Art.-Nr./No d'article	Grösse/grandeur	Preis/prix
8006.20010	26 x 26 cm	171.70



Grillpfanne gerippt
Poêle à grill en fonte
INDUKTIONSGEEIGNET. Gusseisen emailliert,
ohne Deckel und Rezeptbuch
INDUCTION. Fonte d'acier émaillée, sans couvercle
et livre de recettes

Art.-Nr./No d'article	Grösse/grandeur	Preis/prix
8006.20011	26 x 26 cm	108.80

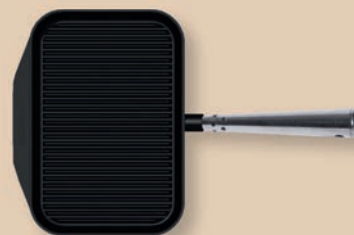

Steakpfanne gerippt
Poêle à steak avec fond nervuré
Gusseisen, schwere Qualität, Griff aus
Edelstahl 18/10
En fonte de qualité massive, poignée en acier
inoxydable 18/10

Art.-Nr./No d'article	Grösse/grandeur	Preis/prix
8006.42310	28 x 20 cm x H 4 cm	270.55



Runde Grillpfanne gerippt
Poêle à grill rond en fonte
INDUKTIONSGEEIGNET. Gusseisen,
für Profigebrauch
INDUCTION. Fonte d'acier brute, pour usage
professionnel

Art.-Nr./No d'article	Grösse/grandeur	Preis/prix
8006.20012	Ø 33 cm	378.80



Grillbürste
Brosse en fil d'acier
mit fünf Reihen Stahldrahtborsten, nicht rostfrei,
auf massivem Holzgriff
avec cinq rangées de poils en fil d'acier, non anti-
rouille, sur un manche en bois massif

Art.-Nr./No d'article	Grösse/grandeur	Preis/prix
8006.48100	30 x 3,5 cm	6.10

SCHÖPF-, KOCHGERÄTE / ACCESSOIRES POUR LA CUISSON



Schöpföffel Louche

Inox 18/10, fugenlos, mit kurzem Stiel
Inox 18/10, monobloc, avec manche court

Art-Nr./No d'article	Grösse/grandeur	Länge/longueur	Preis/prix
8006.42009	Ø 8 cm / 0,12 L	23 cm	18.80



Servier-/Milchkelle Cuillère à arroser

Inox 18/10, fugenlos, hochglänzend, mit zwei Ausgusschnäupen, schwere Qualität
Inox 18/10, monobloc, poli brillant, qualité lourde

Art-Nr./No d'article	Grösse/grandeur	Länge/longueur	Preis/prix
8006.42200	Ø 5 cm / 0,03 L	22 cm	25.40
8006.42201	Ø 6 cm / 0,06 L	23 cm	28.20
8006.42202	Ø 7 cm / 0,08 L	29 cm	31.70
8006.42203	Ø 8 cm / 0,125 L	32 cm	35.15
8006.42204	Ø 9 cm / 0,20 L	32 cm	37.60



Schöpfkelle Louche

Inox 18/10, fugenlos, matt poliert, Massstempe-
lung auf Stiel, schwere Qualität
Inox 18/10, monobloc, poli mat, qualité lourde

Art-Nr./No d'article	Grösse/grandeur	Länge/longueur	Preis/prix
8006.42000	Ø 6 cm / 0,06 L	30 cm	11.70
8006.42001	Ø 8 cm / 0,125 L	34 cm	17.95
8006.42002	Ø 9 cm / 0,20 L	36 cm	19.15
8006.42003	Ø 10 cm / 0,25 L	38 cm	21.15
8006.42008	Ø 11 cm / 0,33 L	42 cm	25.40
8006.42004	Ø 12 cm / 0,50 L	42 cm	30.55
8006.42005	Ø 14 cm / 0,75 L	43 cm	35.15
8006.42006	Ø 16 cm / 1,00 L	47 cm	41.15



Schöpfkelle Louche

Inox 18/10, fugenlos, extra schwere Qualität, mit
Schütterand
Inox 18/10, monobloc, qualité extra-lourde, avec
bord verseur

Art-Nr./No d'article	Grösse/grandeur	Stiel/manche	Preis/prix
8006.40500	Ø 5 cm / 0,03 L	27 cm	19.50
8006.40501	Ø 6 cm / 0,05 L	29 cm	19.95
8006.40502	Ø 7 cm / 0,08 L	30 cm	21.15
8006.40503	Ø 8 cm / 0,125 L	32 cm	24.90
8006.40504	Ø 9 cm / 0,15 L	33,5 cm	25.85
8006.40505	Ø 10 cm / 0,25 L	35 cm	26.55
8006.40506	Ø 11 cm / 0,3 L	36 cm	31.70
8006.40507	Ø 12 cm / 0,35 L	36,5 cm	34.05
8006.40508	Ø 14 cm / 0,55 L	37 cm	39.95

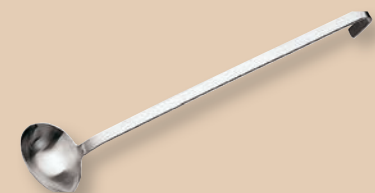

Giesslöffel Cuillère

Inox 18/10, fugenlos, quer
Inox 18/10, monobloc, oblique

Art-Nr./No d'article	Länge/longueur	Preis/prix
8006.42113	38 cm	21.15



Giesslöffel Cuillère

Inox 18/10, fugenlos, perforiert
Inox 18/10, monobloc, perforé

Art-Nr./No d'article	Länge/longueur	Preis/prix
8006.42120	38 cm	22.30



Giesslöffel, längs
Cuillère à arroser

Inox 18/10, fugenlos, schwere Qualität
Inox 18/10, poli brillant, monobloc, qualité lourde

Art-Nr./No d'article	Grösse/grandeur	Stiel/manche	Preis/prix
8006.40513	10 x 7 cm / 0,08 L	37 cm	24.90

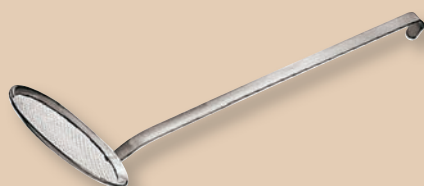

Schaumlöffel
Écumoire

Inox 18/10
Inox 18/10

Art-Nr./No d'article	Grösse/grandeur	Länge/longueur	Preis/prix
8006.50300	16 cm	40 cm	35.15



Schaumlöffel
Écumoire

Inox 18/10
Inox 18/10

Art-Nr./No d'article	Grösse/grandeur	Länge/longueur	Preis/prix
8006.50301	16 cm	40 cm	43.50



Netzschaumlöffel
Écumoire treillis

Inox 18/10, feines Gewebe, schwere Qualität
Inox 18/10, treillis fin, qualité lourde

Art-Nr./No d'article	Grösse/grandeur	Stiel/manche	Preis/prix
8006.50312	Ø 16 cm	40 cm	51.70



Schaumlöffel
Écumoire

Inox 18/10, hochglänzend, flache Form, mit 4 mm Lochung, schwere Qualität
Inox 18/10, poli brillant, qualité lourde

Art-Nr./No d'article	Grösse/grandeur	Stiel/manche	Preis/prix
8006.42100	8 cm	28 cm	11.70
8006.42101	10 cm	32 cm	14.05
8006.42102	12 cm	36 cm	17.95
8006.42103	14 cm	40 cm	22.30
8006.42104	16 cm	43 cm	28.20
8006.42105	18 cm	44 cm	34.65
8006.42106	20 cm	47 cm	42.30



Schaumlöffel
Écumoire

Inox 18/10, fugenlos, extra schwere Qualität
Inox 18/10, monobloc, qualité extra-lourde

Art-Nr./No d'article	Grösse/grandeur	Stiel/manche	Preis/prix
8006.40515	Ø 8 cm	32,5 cm	21.15
8006.40516	Ø 10 cm	33 cm	25.85
8006.40517	Ø 12 cm	38 cm	33.50
8006.40518	Ø 14 cm	40,5 cm	41.15
8006.40519	Ø 16 cm	42 cm	44.65
8006.40520	Ø 18 cm	42,5 cm	51.70
8006.40521	Ø 20 cm	44 cm	62.30



Schaumkelle
Écumoire

Inox 18/10, fugenlos, tiefe Form, 5-6 mm Perforierung
Inox 18/10, monobloc, profondeur, perforée 5-6 mm

Art-Nr./No d'article	Grösse/grandeur	Stiel/manche	Preis/prix
8006.42205	Ø 7 cm / 0,08 L	29 cm	32.30
8006.42206	Ø 8 cm / 0,125 L	32 cm	35.15
8006.42207	Ø 10 cm / 0,25 L	37 cm	37.60
8006.42208	Ø 12 cm / 0,50 L	40 cm	46.90
8006.42209	Ø 14 cm / 0,75 L	41 cm	56.40
8006.42231	Ø 16 cm / 1 L	45 cm	64.65

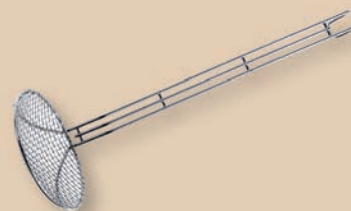

Back-/Fritierlöffel
Écumoire à friture

Inox 18/10, mit Gitternetz, hochglänzend, sehr stabile Ausführung
Inox 18/10, avec carroyage, poli brillant, qualité très stable

Art-Nr./No d'article	Grösse/grandeur	Stiel/manche	Preis/prix
8006.42232	Ø 16 cm	42,5 cm	29.35
8006.42233	Ø 18 cm	42,5 cm	36.95
8006.42234	Ø 20 cm	50 cm	41.15
8006.50307	Ø 24 cm	50 cm	51.70
8006.50308	Ø 28 cm	50 cm	62.30

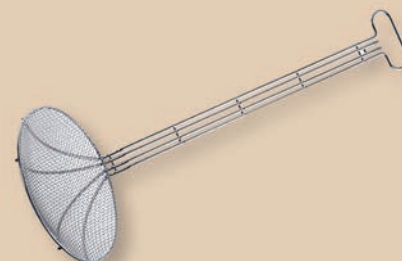

Fritierschaufel
Écumoire à friture

Inox 18/10, rund, elektropoliert, schwere, extra hochwertige Qualität
Inox 18/10, ronde, électro-poli, qualité lourde

Art-Nr./No d'article	Grösse/grandeur	Stiel/manche	Preis/prix
8006.42236	Ø 28 cm	61,5 cm	155.25

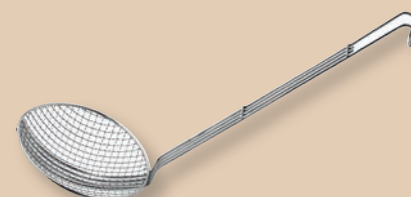

Schaumlöffel tief
Écumoire profonde

Edelstahl, verstärkter Griff, Gewebe: 8 x 8 x 1 mm, besonders tiefe Form
Inox

Art-Nr./No d'article	Grösse/grandeur	Preis/prix
8102.10112	Ø 12 cm x L 52 cm	29.60
8102.10114	Ø 14 cm x L 54 cm	33.50
8102.10116	Ø 16 cm x L 55 cm	35.15
8102.10118	Ø 18 cm x L 57 cm	41.15
8102.10120	Ø 20 cm x L 60 cm	44.65
8102.10124	Ø 24 cm x L 63 cm	52.90
8102.10126	Ø 26 cm x L 65 cm	57.60

SCHÖPF-, KOCHGERÄTE / ACCESSOIRES POUR LA CUISSON

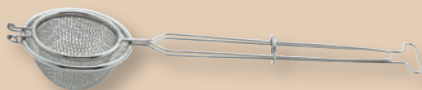
Nestbacklöffel
Nid à friture

Inox
Inox

Art-Nr./No d'article	Grösse/grandeur	Stiel/manche	Preis/prix
8102.17308	Ø 6+8 cm	36 cm	16.80
8102.17310	Ø 8+10 cm	38 cm	18.80

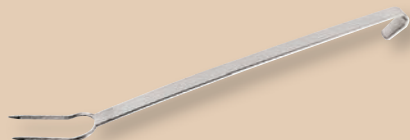
Fleischgabel
Fourchette à viande

Inox 18/10, fugenlos, 2 Zacken
Inox 18/10, monobloc, 2 dents

Art-Nr./No d'article	Länge/longueur	Preis/prix
8006.42121	50 cm	39.95
8006.42122	100 cm	49.35

Back-/Fleischgabel
Fourchette à viande

Inox 18/10, fugenlos, extra schwere Qualität
Inox 18/10, monobloc, qualité lourde

Art-Nr./No d'article	Grösse/grandeur	Stiel/manche	Preis/prix
8006.40533	12,5 cm	51 cm	38.80

Backschaufel
Spatule

Inox 18/10, fugenlos
Inox 18/10, monobloc

Art-Nr./No d'article	Grösse/grandeur	Stiel/manche	Preis/prix
8006.42110	10 cm	36 cm	19.15
8006.42111	12 cm	39 cm	23.50

Backschaufel
Spatule

Inox 18/10, fugenlos, extra schwere Qualität
Inox 18/10, monobloc, qualité extra lourde

Art-Nr./No d'article	Grösse/grandeur	Stiel/manche	Preis/prix
8006.40530	11 x 11 cm	28 cm	26.95
8006.40529	11 x 11 cm	36 cm	34.65

Backschaufel
Spatule

Inox 18/10, fugenlos, perforiert
Inox 18/10, monobloc, perforé

Art-Nr./No d'article	Grösse/grandeur	Stiel/manche	Preis/prix
8006.42125	10 cm	36 cm	22.30
8006.42126	12 cm	39 cm	23.50

Backschaufel
Spatule

mit perforiertem Blatt, fugenlos, Inox 18/10,
schwere Qualität
Inox 18/10, perforé, monobloc, qualité lourde

Art-Nr./No d'article	Grösse/grandeur	Stiel/manche	Preis/prix
8006.40526	9 x 7,5 cm	25 cm	26.55
8006.40527	9,5 x 10 cm	36,5 cm	29.60
8006.40528	10,5 x 12 cm	39,5 cm	34.05

Reduzierspatel
Spatule à réduire

Inox 18/10
Inox 18/10

Art-Nr./No d'article	Grösse/grandeur	Stiel/manche	Preis/prix
8006.42118	12 x 15 cm	50 cm	51.70
8006.42114	12 x 15 cm	100 cm	64.65

Kippbratpfannenschaufel
Pelle à retourner

Inox 18/10, fugenlos, mit kurzem Stiel, schwere
Qualität

Inox 18/10, monobloc, manche courte, qualité
lourde

Art-Nr./No d'article	Grösse/grandeur	Stiel/manche	Preis/prix
8006.40531	18 x 14 cm	28 cm	54.05

Kippbratpfannenschaufel
Pelle à retourner

mit perforiertem Blatt, fugenlos, Inox 18/10,
schwere Qualität

Inox 18/10, monobloc, perforé, qualité lourde

Art-Nr./No d'article	Grösse/grandeur	Stiel/manche	Preis/prix
8006.40532	18 x 14 cm	28 cm	54.05

Fischbakschaufel
Pelle à poisson

Inox 18/10, mit perforiertem Blatt, fugenlos,
schwere Qualität

Inox 18/10, perforé, monobloc, qualité lourde

Art-Nr./No d'article	Grösse/grandeur	Stiel/manche	Preis/prix
8006.40522	11 x 11 cm	36 cm	34.65

Fischheber
Pelle à poisson

Inox 18/10, fugenlos
Inox 18/10, monobloc

Art-Nr./No d'article	Grösse/grandeur	Stiel/manche	Preis/prix
8006.42127	18 x 10 cm	34 cm	25.85



Backschaufel
Pelle à retourner

Inox 18/10, mit geschlossenem Hohlgriff, schwere Qualität
Inox 18/10, manche creux fermée, qualité lourde

Art-Nr./No d'article	Grösse/grandeur	Stiel/manche	Preis/prix
8006.40540	21,5 x 17,5 cm	15,5 cm	56.40



Backschaufel, gelocht
Pelle à retourner, perforée

Inox 18/10, mit geschlossenem Hohlgriff, schwere Qualität
Inox 18/10, manche creux fermée, qualité lourde

Art-Nr./No d'article	Grösse/grandeur	Stiel/manche	Preis/prix
8006.40541	21,5 x 17,5 cm	15,5 cm	76.20



Pommes frites Schaufel
Pelle à pommes frites

Inox 18/10, schwere Qualität
Inox 18/10, qualité lourde

Art-Nr./No d'article	Grösse/grandeur	Stiel/manche	Preis/prix
8006.40534	23 x 21 cm	14 cm	29.60
8006.40535*	23 x 21 cm	14 cm	29.60

* Für Linkshänder/pour gaucher



Spaghettiheber
Cuillère à spaghetti

Inox 18/10, hochglänzend
Inox 18/10, poli brillant

Art-Nr./No d'article	Grösse/grandeur	Stiel/manche	Preis/prix
8006.40536	8 x 7 cm	30 cm	14.55



Spaghettiheber lang
Cuillère à spaghetti long

Edelstahl, schwere Qualität
Inox, qualité lourde

Art-Nr./No d'article	Grösse/grandeur	Stiel/manche	Preis/prix
8006.40542	10 x 8,5 cm	48 cm	18.80



Spaghettizange
Pince à spaghetti

Inox 18/10, fugenlos
Inox 18/10, monobloc

Art-Nr./No d'article	Länge/longueur	Preis/prix
8006.40537	20 cm	7.95



Spaghettizange lang
Pince à spaghetti long

Edelstahl
Inox

Art-Nr./No d'article	Länge/longueur	Preis/prix
8006.40543	31 cm	11.70

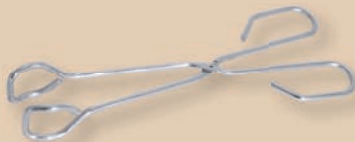

Grillzange
Pince à grill

aus Inox 18/10, Greiffläche geriffelt
Inox 18/10, surface de prise griffée

Art-Nr./No d'article	Länge/longueur	Preis/prix
8006.40410	26 cm	8.90
8006.40411	30 cm	10.55
8006.40412	35 cm	15.25



Mehrzweckzange
Pince tout-usage

Inox 18/10, fugenlos, extra schwere Qualität
Inox 18/10, monobloc, qualité extra-lourde

Art-Nr./No d'article	Länge/longueur	Preis/prix
8006.40418	26 cm	38.20



Doppelwender und Grillzange
Pince à tourner et servir

Aluminium, hitzeresistent bis + 450° C
Alu, résistant jusqu'à 450° C

Art-Nr./No d'article	Länge/longueur	Preis/prix
8006.90702	27,5 cm	26.95



Allzweckzange
Pince universelle

Inox 18/10, seidenmatt gebürstet, mit Feder und Kunststoffummanteltem Zugverschluss, mittel-schwere Qualität

Inox 18/10, brossé foto mat, avec fermeture à ressort gainée plastique, qualité demi-lourde, satiné

Art-Nr./No d'article	Länge/longueur	Preis/prix
8006.42210	23 cm	13.50
8006.42211	30 cm	13.95
8006.42212	40 cm	14.80



Allzweckzange
Pince universelle

Inox 18/10, schwere Qualität
Inox 18/10, qualité lourde

Art-Nr./No d'article	Länge/longueur	Preis/prix
8006.40415	24 cm	18.80
8006.40416	30 cm	19.95
8006.40417	41 cm	23.50

SCHÖPF-, KOCHGERÄTE / ACCESSOIRES POUR LA CUISSON

Pfannenwender
Spatule à frire

aus unbehandeltem, naturbelassenem Buchenholz
 en bois d'hêtre naturel, non traité

Art-Nr./No d'article	Grösse/grandeur	Länge/longueur	Preis/prix
8006.60150	12 x 6 cm	30 cm	1.95

Kochlöffel rund
Mouvette ronde

aus unbehandeltem, naturbelassenem Buchenholz
 en bois d'hêtre naturel, non traité

Art-Nr./No d'article	Länge/longueur	Preis/prix
8006.60160	24 cm	1.15
8006.60161	30 cm	1.25
8006.60162	32 cm	1.40
8006.60163	36 cm	1.75
8006.60164	40 cm	2.10
8006.60165	45 cm	2.30
8006.60166	50 cm	4.90
8006.60167	60 cm	5.85
8006.60168	80 cm	11.70
8006.60169	100 cm	16.40

Kochlöffel oval
Mouvette ovale

aus unbehandeltem, naturbelassenem Buchenholz
 en bois d'hêtre naturel, non traité

Art-Nr./No d'article	Länge/longueur	Preis/prix
8006.60170	25 cm	1.15
8006.60171	30 cm	1.40
8006.60172	35 cm	1.60

TRIANGLE
Pinzette, gerade
Pince, plane

Edelstahl
 Inox

Art-Nr./No d'article	Länge/longueur	Preis/prix
8006.42605	20 cm	18.80
8006.42606	30 cm	21.15
8006.42607	35 cm	26.55

TRIANGLE
Pinzette, zweifach gekröpft
Pince, coudée

Edelstahl
 Inox

Art-Nr./No d'article	Länge/longueur	Preis/prix
8006.42609	14 cm	15.95
8006.42608	20 cm	18.80

TRIANGLE
Pinzette, gekröpft
Pince, coudée

Edelstahl
 Inox

Art-Nr./No d'article	Länge/longueur	Preis/prix
8006.42613	15 cm	17.15

TRIANGLE
Gourmetpinzette
Pinces gourmandes

Edelstahl
 Inox

Art-Nr./No d'article	Länge/longueur	Preis/prix
8006.42604	18,5 cm	28.20

TRIANGLE
Probierlöffel mit Pinzette
Cuillère de dégustation avec pince

Edelstahl
 Inox

Art-Nr./No d'article	Länge/longueur	Preis/prix
8006.42602	17 cm	28.90

TRIANGLE
Probierlöffel mit Pinzette
Cuillère de dégustation avec pince

Edelstahl, schwarz
 Inox, noir

Art-Nr./No d'article	Länge/longueur	Preis/prix
8006.42601	17 cm	32.90

TRIANGLE
Probierlöffel mit Pinzette
Cuillère de dégustation avec pince

Edelstahl, goldfarben
 Inox, couleur dorée

Art-Nr./No d'article	Länge/longueur	Preis/prix
8006.42603	17 cm	32.90

TRIANGLE
Präzisionspinzette gerade
Pincettes de précision plane

Edelstahl
 Inox

Art-Nr./No d'article	Länge/longueur	Preis/prix
8006.42610	15 cm	17.15

TRIANGLE
Präzisionspinzette gerade
Pincettes de précision plane

Edelstahl, schwarz
 Inox, noir

Art-Nr./No d'article	Länge/longueur	Preis/prix
8006.42611	15 cm	21.85

TRIANGLE
Präzisionspinzette gerade
Pincettes de précision plane

Edelstahl, goldfarben
 Inox, couleur dorée

Art-Nr./No d'article	Länge/longueur	Preis/prix
8006.42612	15 cm	21.85



Polyamid, schwarz
Ergonomische Form
Dauerhaft hitzebeständig bis 220°C
Spülmaschinengeeignet

Polyamide, noir
Forme ergonomique
Chaleur constante jusqu'à 220°C
Résistant au lave vaisselle



+220°C



Bratenwender, geschlitzt
Spatule pour rôtis, ouverte

Art.-Nr./No d'article	Masse/mesure	Preis/prix
8582.00600	11,5 x 9,5 x 35 cm	9.85



Bratenwender, perforiert
Spatule pour rôtis, perforée

Art.-Nr./No d'article	Masse/mesure	Preis/prix
8582.88640	13 x 6,5 x 29 cm	6.95



Toast-Zange
Pince à toast

Art.-Nr./No d'article	Masse/mesure	Preis/prix
8582.00601	10 x 8 x 28 cm	11.70



Bratenwender, geschlitzt
Spatule pour rôtis, ouverte

Art.-Nr./No d'article	Masse/mesure	Preis/prix
8582.00604	15 x 7,5 x 30 cm	6.95



Bratenwender «PRO»
Spatule pour rôtis «PRO»

Art.-Nr./No d'article	Masse/mesure	Preis/prix
8582.88642	14 x 7 x 29 cm	7.25



Schöpföffel
Louche

Art.-Nr./No d'article	Masse/mesure	Preis/prix
8582.00606	Ø 9 cm x 32 cm	10.55



Bratenwender
Pince à tourner

Art.-Nr./No d'article	Masse/mesure	Preis/prix
8582.00603	11 x 9,5 x 35 cm	9.85



Salat-Zange
Pince à salade

Art.-Nr./No d'article	Masse/mesure	Preis/prix
8582.00605	10 x 6 x 33 cm	10.55



Spaghettizange
Pince à spaghetti

Art.-Nr./No d'article	Masse/mesure	Preis/prix
8582.88637	Ø 9 cm x 24 cm	9.85

SCHÖPF-, KOCHGERÄTE / ACCESSOIRES POUR LA CUISSON

KISAG
Bratwender
Spatule à frire

aus Polyamid, für Antihaft-Pfannen, hitzeresistent bis + 220° C

Polyamide, pour poêle anti-adhésive, résistant jusqu'à 220° C

Art-Nr./No d'article	Länge/longueur	Preis/prix
8006.70200	32 cm	5.85

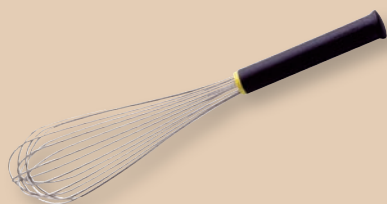
Schneebeesen
Fouet à sauces

klassische Form, mit Exoglass-Griff
Forme classique, avec manche Exoglass

Art-Nr./No d'article	Grösse/grandeur	Preis/prix
8006.50180	25 cm	23.50
8006.50181	30 cm	29.60
8006.50182	35 cm	31.70
8006.50183	40 cm	33.50
8006.50184	45 cm	45.85
8006.50185	50 cm	55.25

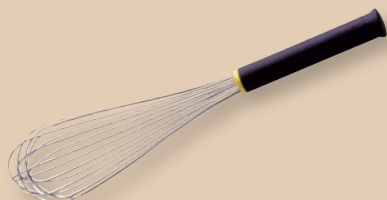
Schneebeesen
Fouet à blancs

flexible Drähte, speziell für Eiweiss,
 mit Exoglass-Griff
*filis souples, spécial pour blancs,
 avec manche Exoglass*

Art-Nr./No d'article	Grösse/grandeur	Preis/prix
8006.50190	45 cm	56.40



Rührbesen
Fouet à fils rigides

starre Drähte, speziell für Mayonnaise und andere festen Cremes, mit Exoglass-Griff
filis rigides, spécial pour mayonnaise et autres crèmes fermés, avec manche Exoglass

Art-Nr./No d'article	Grösse/grandeur	Preis/prix
8006.50191	40 cm	52.90
8006.50192	45 cm	57.60

Schneebeesen
Fouet

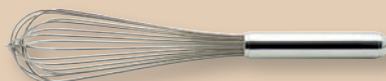
Art-Nr./No d'article	Grösse/grandeur	Preis/prix
8102.13525	25 cm	16.80
8102.13530	30 cm	18.80
8102.13535	35 cm	21.15
8102.13540	40 cm	23.50
8102.13545	45 cm	25.85

Rührbesen
Fouet

Art-Nr./No d'article	Grösse/grandeur	Preis/prix
8102.13635	35 cm	23.50
8102.13640	40 cm	25.85
8102.13645	45 cm	27.75
8102.13650	50 cm	28.90
8102.13660	60 cm	32.90

Kesselbesen
Fouet

Art-Nr./No d'article	Grösse/grandeur	Preis/prix
8102.13610	95 cm	93.75
8102.13615	115 cm	112.30
8102.13620	135 cm	161.15

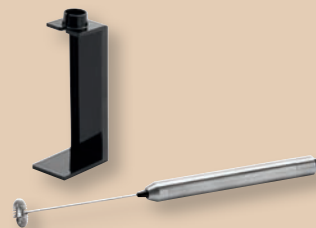
Milchaufschäumer
Mousseur à lait

schlankes Gehäuse aus Edelstahl, mit Ständer, leistungsstarker Motor, 13'000 U/Minute, mit 2 AAA-Batterien
Inox, comprend un support pratique

Art-Nr./No d'article	Grösse/grandeur	Preis/prix
8102.18420	Ø 1,2 cm x H 25 cm	21.15

«Exoglass®»
Rührspaten
Spatule

aus Exoglass, hitzebeständig bis 220° C
en Exoglass, résistant à la chaleur jusqu'à 220° C

Art-Nr./No d'article	Grösse/grandeur	Preis/prix
8006.90354	25 cm	7.25
8006.90355	30 cm	8.90
8006.90356	35 cm	9.85
8006.90357	40 cm	11.70
8006.90358	45 cm	17.40
8006.90359	50 cm	19.95

Rührspaten
Spatule

Edelstahl, hochglänzend, schwere Qualität
Acier fin, poli brillant, qualité lourde

Art-Nr./No d'article	Spatel/spatule	Länge/longueur	Preis/prix
8006.42215	23x12 cm	61 cm	43.50
8006.42216	23x12 cm	105 cm	54.05
8006.42217	23x12 cm	120 cm	64.65
8006.42218	23x12 cm	150 cm	79.85



VICTORINOX
Spachtel für Köche und Konditoren
Spatule pour cuisiniers et pâtisseries

Griff schwarz, flexibel
Manche noir, flexible

Art-Nr./No d'article	Streichlänge/langueur utile	Preis/prix
8006.80912	20 cm	28.20
8006.80913	23 cm	28.90
8006.80914	25 cm	30.55



VICTORINOX
Spachtel, abgekröpft
Spatule coudée

Griff schwarz
Manche noir

Art-Nr./No d'article	Grösse/grandeur	Preis/prix
8006.80340	12 cm	28.90



TRIANGLE
Streichpalette
Grande spatule
Edelstahl, Kunststoff
Inox, plastique

Art-Nr./No d'article	Länge/langueur	Preis/prix
8006.42623	20 cm	29.60



TRIANGLE
Streichpalette, gewinkelt
Grande spatule coudée
Edelstahl, Kunststoff
Inox, plastique

Art-Nr./No d'article	Länge/langueur	Preis/prix
8006.42624	20 cm	35.15



TRIANGLE
Palette, gewinkelt
Spatule coudée
Edelstahl, Kunststoff
Inox, plastique

Art-Nr./No d'article	Länge/langueur	Preis/prix
8006.42625	20 cm	32.90



TRIANGLE
Palette, gewinkelt, geschlitzt
Spatule rainurée
Edelstahl, Kunststoff
Inox, plastique

Art-Nr./No d'article	Länge/langueur	Preis/prix
8006.42626	12 cm	39.95



Winkelpalette
Palette coudée
Inox 18/10
Inox 18/10

Art-Nr./No d'article	Länge/langueur	Preis/prix
8006.81040	22 cm	15.95
8006.81041	26 cm	17.95



Pizzaspatel
Palette à pizza
Inox 18/10
Inox 18/10

Art-Nr./No d'article	Grösse/grandeur	Preis/prix
8006.90028	15 x 9 cm	21.15



Hamburgerspatel
Palette à hamburger
Inox 18/10
Inox 18/10

Art-Nr./No d'article	Grösse/grandeur	Preis/prix
8006.81045	15 x 14 cm	23.40



TRIANGLE
Confiseriepalette
Spatule à confiserie
Edelstahl, Kunststoff
Inox, plastique

Art-Nr./No d'article	Länge/langueur	Preis/prix
8006.42621	12 cm	21.85



TRIANGLE
Confiseriepalette, gewinkelt
Spatule à confiserie, coudée
Edelstahl, Kunststoff
Inox, plastique

Art-Nr./No d'article	Länge/langueur	Preis/prix
8006.42622	9 cm	21.85
8006.42620	12 cm	27.75



TRIANGLE
Quenelle Löffel, klein
Cuillère à quenelle, petite
Edelstahl
Inox

Art-Nr./No d'article	Länge/langueur	Preis/prix
8006.42631	6 cm	21.85



TRIANGLE
Quenelle Löffel, gross
Cuillère à quenelle, grand
Edelstahl
Inox

Art-Nr./No d'article	Länge/langueur	Preis/prix
8006.42632	8 cm	28.90



Dekorierlöffel
Cuillère à décorer
Edelstahl 18/10, einfache Dekoration auf Platten und Tellern mit Saucen, Crèmes oder Coulis
inox 18/10, pour décorer facilement plats et assiettes avec des sauces, crèmes ou coulis

Art-Nr./No d'article	Grösse/grandeur	Inhalt/capacité	Preis/prix
8006.42342	19 cm	10 ml	14.30

SCHÖPF-, KOCHGERÄTE / ACCESSOIRES POUR LA CUISSON

**«Elvea»
Gummispachtel
Spatule**

Griff Exoglass, Spachtel Thermoplastik bis 70° C
Manche exoglass, palette thermoplastique jusqu'à 70° C

Art-Nr./No d'article	Grösse/grandeur	Preis/prix
8006.90760	25 cm	10.55
8006.90761	35 cm	11.70
8006.90762	45 cm	15.25

**«Spatulon»
Gummispachtel mit Vertiefung
Spatule avec renforcement**

Griff Exoglass, Spachtel Thermoplastik bis 70° C.
Ideal zum Befüllen von Spritzbeuteln.
Manche exoglass, palette thermoplastique jusqu'à 70° C. Idéale pour remplir les poches à pâtisserie notamment.

Art-Nr./No d'article	Grösse/grandeur	Preis/prix
8006.96205	25 cm	13.25
8006.96206	33 cm	15.95

**«Elveo»
Gummispachtel schmal
Spatule spéciale pots**

schmale Form, speziell geeignet für zylindrische Töpfe, z.B. Konfitürengläser, Pacojet® Behälter, etc. Resistent bis 260° C.
Spatule avec palette étroite, pratique pour racler les contenants cylindriques: pots à confiture, pots de Pacojet®. Palette résistante jusqu'à 260° C

Art-Nr./No d'article	Grösse/grandeur	Preis/prix
8006.96210	25 cm	22.95

**«Elveo»
Gummispachtel
Spatule**

Griff Exoglass, Schaufelstück bis 260° C
Manche exoglass, palette résistante jusqu'à 260° C

Art-Nr./No d'article	Grösse/grandeur	Preis/prix
8006.90763	25 cm	24.95
8006.90764	35 cm	27.75
8006.90765	45 cm	33.50

**«Silveo»
Schaber
Spatule racloir**

Dank weitem und flexiblem Silikonshaber speziell für grosse Flächen geeignet. Resistent bis 260° C.
Raclage sans effort du fond des bassines grâce à la palette en silicone souple et arrondie. Palette résistante jusqu'à 260° C

Art-Nr./No d'article	Grösse/grandeur	Preis/prix
8006.96211	21,5 cm	34.65

**Dressiernadel
Aiguille à brider**

gerade, Inox 18/10
droite, inox 18/10

Art-Nr./No d'article	Länge/longueur	Preis/prix
8006.80156	18 cm	13.95
8006.80157	20 cm	13.95

**Dressiernadel
Aiguille à brider**

gebogen, Inox 18/10
courbe, inox 18/10

Art-Nr./No d'article	Länge/longueur	Preis/prix
8006.80158	18 cm	13.95
8006.80159	20 cm	14.30

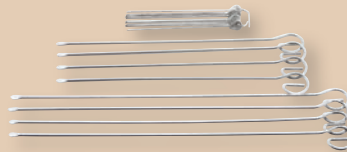
**Rouladen-/Schaschliknadeln
Aiguilles à roulades/Schaschlik**

Art-Nr./No d'article	Grösse/grandeur	Menge/quantité	Preis/prix
8102.14800	10 cm	10 pcs.	3.75/set
8102.15200	21 cm	4 pcs.	4.65/set
8102.15220	28 cm	4 pcs.	7.50/set

**Fischgrätepinzette
Pincette à arêtes de poisson**

aus Inox 18/10, schwere Qualität
Inox 18/10, qualité lourde

Art-Nr./No d'article	Grösse/grandeur	Preis/prix
8102.11992	1,8 x 2,6 x H 13,2 cm	8.90

**Fischgrätezange
Pince à arêtes de poisson**

aus massivem Inox 18/10, mit gezahnter Greiffläche
Inox 18/10, massif, surface de contact dentée

Art-Nr./No d'article	Länge/longueur	Preis/prix
8006.40420	15 cm	19.95

**Fischentschupper
Écailleur**

Edelstahl, leichte Ausführung
Inox, qualité légère

Art-Nr./No d'article	Länge/longueur	Preis/prix
8006.40544	19,5 x 3 cm	4.45

KÜCHENUTENSILIEN / USTENSILES DE CUISINE

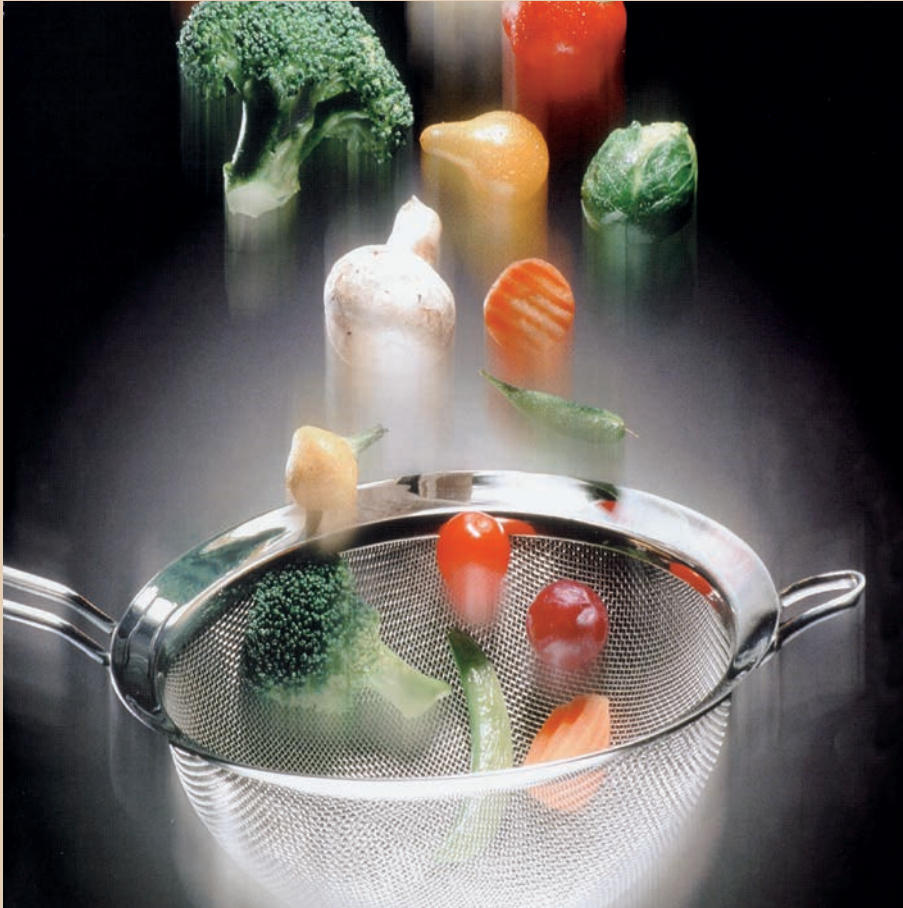

Passiersieb

Passoire

Inox 18/10, Gestell elektropoliert, Griff zur Hälfte ovalisiert, Gewebe mittel 1,5 mm, Einsätze leicht auswechselbar

Inox 18/10, etagère electropolie, poignée à moitié ovalisée, tissu 1,5mm, éléments facilement interchangeables

Art-Nr./No d'article	Grösse/grandeur	Preis/prix
8102.12201	Ø 22 cm	78.55
8102.12601	Ø 26 cm	88.10
8102.13001	Ø 30 cm	113.50
8102.12401	Ø 34 cm	130.55

Ersatzteile/Pièces de rechange



Ersatz-Einsätze, Grob 3,5 mm Pièces détachées, gros 3,5 mm

8102.12610	Ø 26 cm	43.50
8102.13010	Ø 30 cm	52.90
8102.13410	Ø 34 cm	64.65



Ersatz-Einsätze, Mittel 1,5 mm Pièces détachées, moyen 1,5 mm

8102.12211	Ø 22 cm	39.40
8102.12611	Ø 26 cm	43.50
8102.13011	Ø 30 cm	56.40
8102.13411	Ø 34 cm	66.95



Ersatz-Einsätze, Fein doppelt 0,4/3,5 mm Pièces détachées, fin double 0,4/3,5 mm

8102.12212	Ø 22 cm	55.25
8102.12612	Ø 26 cm	70.55
8102.13012	Ø 30 cm	86.90
8102.13412	Ø 34 cm	112.30



Bouillon-Spitzsieb Passe-bouillon chinois

Inox 18/10
Inox 18/10

Art-Nr./No d'article	Grösse/grandeur	Preis/prix
8006.40002	Ø 8 cm	13.25
8006.40003	Ø 14 cm	22.95
8006.40004	Ø 16 cm	27.75
8006.40005	Ø 18 cm	34.05



Passiertuch Etamine

gazeartige Rohleinen, gebleicht, Schnittkanten gesäumt, kochfest
en lins rudes naturelles, blanchie, arête de coupe bordée, résistant à la cuisson

Art-Nr./No d'article	Grösse/grandeur	Preis/prix
8005.03740	80 x 95 cm	23.50



Küchensieb Passoire

Art-Nr./No d'article	Grösse/grandeur	Preis/prix
8102.15407	7 cm	6.95
8102.15410	10 cm	9.35
8102.15414	14 cm	15.25
8102.15416	16 cm	18.80
8102.15418	18 cm	21.15
8102.15420	20 cm	25.40
8102.15426	26 cm	31.70



Passiersieb Passoire

Art-Nr./No d'article	Grösse/grandeur	Preis/prix
8102.17022	22 cm	57.60
8102.17026	26 cm	64.65
8102.17030	30 cm	82.10
8102.17034	34 cm	104.20

KÜCHENUTENSILIEN / USTENSILES DE CUISINE



**Spitzsieb
Chinois**
Inox 18/10
Inox 18/10

Art-Nr./No d'article	Grösse/grandeur	Preis/prix
8006.40193	Ø 14 cm	27.75
8006.40194	Ø 16 cm	38.80
8006.40195	Ø 18 cm	42.30
8006.40196	Ø 20 cm	44.65
8006.40197	Ø 22 cm	51.70
8006.40198	Ø 24 cm	57.60
8006.40199	Ø 26 cm	66.95



**Träger für Spitzsieb
Support pour chinois**
Inox 18/10
Inox 18/10

Art-Nr./No d'article	Grösse/grandeur	Preis/prix
8006.40178	Ø 18 cm x H 28 cm	35.15



**Spitzsieb mit Gazeboden
Chinois treilli fin**
Inox 18/10
Inox 18/10

Art-Nr./No d'article	Grösse/grandeur	Preis/prix
8006.40210	Ø 20 cm	66.95
8006.40211	Ø 24 cm	73.85



**Spitzsieb mit Verstärkung
Chinois avec treilli et croisillon de renfort**
Inox 18/10
Inox 18/10

Art-Nr./No d'article	Grösse/grandeur	Preis/prix
8006.40000	Ø 20 cm	76.20
8006.40001	Ø 24 cm	85.75



**Passiersieb
Chinois**

Exoglass, feine Filtration dank dreimaschigem Geflecht des Siebes, 2 Stützhaken, Kreuzverstärkung aus rostfreiem Stahlraht

Exoglass, finesse de filtration uniques grâce à la maille triple du tamis, 2 pattes d'appu, croisillons de renfort en fil d'acier inoxydable

Art-Nr./No d'article	Grösse/grandeur	Preis/prix
8006.90895	Ø 20,0 x H 22 cm	117.25
8006.90896	Ø 25,5 x H 27 cm	157.60



**Ständer
Support pour chinois**

Verchromt, für Spitz- und Passiersiebe Ø 20 cm
Chromé, pour tout chinois et passe-sauce Ø 20 cm

Art-Nr./No d'article	Grösse/grandeur	Preis/prix
8006.90881	H 21,5 cm	40.65



**Automatischer Trichter
Entonnoir automatique**

Inox. Dieser Trichter ist sehr praktisch zum schnellen und präzisen Füllen von Backformen, Gussformen und Gläsern. Geeignet zur Verarbeitung von Erzeugnissen mit flüssiger Konsistenz. Geliefert mit 2 Düsen mit Ø 3 und 6 mm Füllspitze, austauschbar und eine Ø 8 mm Füllspitze ohne Düse. *Inox. L'entonnoir automatique est très pratique pour le remplissage rapide et précis des moules, empreintes et verres. Adapté aux produits de consistance liquide. Livrés avec 2 buses de sorties Ø 3 et 6 mm interchangeables et une sortie Ø 8 mm sans buse.*

Art-Nr./No d'article	Grösse/grandeur	Preis/prix
8006.90880	1,9 L / Ø 18,5 x H 18 cm	272.90

Zubehör/Accessoires	Preis/prix
8006.90881 Ständer/Support	40.65



**Schneeschlaggkessel
Bassine hémisphérique**

Inox 18/10
Inox 18/10

Art-Nr./No d'article	Grösse/grandeur	Preis/prix
8006.40172	2,7 L / Ø 22 x H 12,0 cm	70.55
8006.40173	4,0 L / Ø 26 x H 14,0 cm	91.60
8006.40174	9,5 L / Ø 32 x H 18,0 cm	123.50
8006.40175	14,0 L / Ø 36 x H 20,5 cm	161.15
8006.40176	18,0 L / Ø 40 x H 21,5 cm	198.95



**Fuss für Schneeschlaggkessel
Base pour bassine hémisphérique**

Inox 18/10
Inox 18/10

Art-Nr./No d'article	Grösse/grandeur	für/pour Ø	Preis/prix
8006.40181	Ø 16 cm	22 / 26	42.30
8006.40182	Ø 22 cm	32 / 36 / 40	50.55



**Küchenschüssel
Bassine**

Inox 18/10, innen und aussen poliert, bauchige Form, bordierter Rand
Inox 18/10, bord renforcé, poli intérieur et extérieur, forme bombée

Art-Nr./No d'article	Grösse/grandeur	Preis/prix
8102.23316	0,50 L / Ø 16 x H 6,5 cm	7.25
8102.23318	0,75 L / Ø 18 x H 7,5 cm	9.85
8102.23320	1,00 L / Ø 20 x H 8,0 cm	11.70
8102.23322	1,50 L / Ø 22 x H 8,0 cm	13.95
8102.23324	2,00 L / Ø 24 x H 8,5 cm	14.80
8102.23326	3,00 L / Ø 26 x H 9,5 cm	18.80
8102.23328	4,00 L / Ø 28 x H 10,0 cm	21.15
8102.23330	5,00 L / Ø 30 x H 11,0 cm	23.50
8102.23332	6,00 L / Ø 32 x H 12,0 cm	27.75
8102.23335	8,00 L / Ø 35 x H 13,0 cm	32.30

**BEST
PRICE**



**Küchenschüssel
Bassine**

Inox 18/10, Aussenseite poliert, Innenseite satiniert, bauchige, hohe Form, bordierter Rand
Inox 18/10, poli à l'extérieur, satiné à l'intérieur, forme haut et bombée, bord renforcé

Art-Nr./No d'article	Grösse/grandeur	Preis/prix
8102.25214	0,5 L / Ø 14 x H 6,5 cm	6.95
8102.25218	1,5 L / Ø 18 x H 7,5 cm	11.25
8102.25222	3,0 L / Ø 22 x H 9,5 cm	15.95
8102.25226	5,0 L / Ø 26 x H 12,0 cm	21.15
8102.25230	8,0 L / Ø 30 x H 13,5 cm	26.95
8102.25236	12,0 L / Ø 36 x H 15,0 cm	36.95



**Schüssel
Bassine**

Inox 18/10
Inox 18/10

Art-Nr./No d'article	Grösse/grandeur	Preis/prix
8006.43100	1 L / Ø 16,5 x H 7,5 cm	21.85
8006.43101	2 L / Ø 22,0 x H 7,5 cm	30.55
8006.43102	3 L / Ø 24,0 x H 9,5 cm	35.15
8006.43103	6 L / Ø 30,5 x H 12,0 cm	56.40
8006.43104	8 L / Ø 32,5 x H 14,0 cm	62.30
8006.43105	11 L / Ø 38,0 x H 14,5 cm	88.10
8006.43106	14 L / Ø 40,0 x H 15,5 cm	98.55



**Schüssel
Bassine**

Inox 18/10, tief, extra schwere Qualität
Inox 18/10, haute, qualité extra-lourde

Art-Nr./No d'article	Grösse/grandeur	Preis/prix
8006.40090	1 L / Ø 15,5 x H 9,0 cm	18.80
8006.40091	2 L / Ø 19,0 x H 11,5 cm	25.40
8006.40092	3 L / Ø 22,0 x H 12,0 cm	34.05
8006.40093	5 L / Ø 27,0 x H 13,5 cm	46.90
8006.40094	6 L / Ø 29,0 x H 15,0 cm	50.55
8006.40095	8 L / Ø 30,5 x H 17,0 cm	58.80
8006.40096	11 L / Ø 35,5 x H 18,5 cm	82.10
8006.40097	17 L / Ø 40,0 x H 20,0 cm	148.20
8006.40098	25 L / Ø 45,0 x H 22,0 cm	173.95
8006.40099	33 L / Ø 50,0 x H 24,0 cm	223.45



**Thermoschüssel
Bol thermo**

Inox, doppelwandig, Aussenseite satiniert, Innenseite hochglanzpoliert, mit Deckel, hält Inhalt bis zu 5 Stunden warm oder kalt
En inox, double paroi, extérieur satiné, intérieur poli miroir, avec couvercle, garde le contenu au frais ou au chaud jusqu'à 5 heures.

Art-Nr./No d'article	Grösse/grandeur	Preis/prix
8102.24020	1,0 L / Ø 16,5 x H 12 cm	37.60
8102.24026	1,8 L / Ø 21,0 x H 13 cm	51.70
8102.24030	3,0 L / Ø 22,5 x H 16 cm	64.65



**Schüssel
Bassine**

Polypropylen
Polypropylène

Art-Nr./No d'article	Grösse/grandeur	Preis/prix
8006.43200	0,9 L / Ø 16 x H 7,0 cm	6.10
8006.43201	1,6 L / Ø 20 x H 8,5 cm	8.20
8006.43202	2,8 L / Ø 24 x H 10,0 cm	11.25
8006.43203	4,5 L / Ø 28 x H 11,0 cm	16.40
8006.43204	6,5 L / Ø 32 x H 12,5 cm	21.15
8006.43205	10,0 L / Ø 36 x H 14,0 cm	24.90
8006.43206	13,5 L / Ø 40 x H 15,5 cm	27.75



**Schüssel
Bassine**

Polypropylen
Polypropylène

Art-Nr./No d'article	Grösse/grandeur	Preis/prix
8310.00640	0,5 L / Ø 13,0 x H 6 cm	3.40
8310.00650	1,0 L / Ø 17,0 x H 8 cm	4.90
8310.00660	2,5 L / Ø 23,5 x H 11 cm	9.35
8310.00670	4,5 L / Ø 28,0 x H 14 cm	11.70
8310.00680	7,0 L / Ø 32,5 x H 16 cm	17.60
8310.00690	11,0 L / Ø 38,0 x H 18 cm	19.50



**Gemüsesieb
Passoire à légumes**

Inox 18/10, extra schwere Qualität
Inox 18/10, qualité extra-lourde

Art-Nr./No d'article	Grösse/grandeur	Preis/prix
8006.40318	3,5 L / Ø 24 x H 12,0 cm	139.90
8006.40319	5,5 L / Ø 28 x H 14,0 cm	161.15
8006.40320	8,8 L / Ø 32 x H 16,0 cm	185.85
8006.40321	12,8 L / Ø 36 x H 18,5 cm	211.55
8006.40322	17,0 L / Ø 40 x H 20,0 cm	249.35
8006.40323	24,5 L / Ø 45 x H 22,5 cm	272.90
8006.40324	32,5 L / Ø 50 x H 24,0 cm	336.40



**Gemüsesieb
Passoire à légumes**

Art-Nr./No d'article	Grösse/grandeur	Preis/prix
8102.21424	24 cm	19.95
8102.21429	29 cm	25.40
8102.21435	35 cm	32.90



**Durchschlag mit Haken
Passoire hémisphérique avec crochet**

Inox 18/10
Inox 18/10

Art-Nr./No d'article	Grösse/grandeur	Preis/prix
8006.40292	2,7 L / Ø 22 x H 12 cm	91.60
8006.40293	4,0 L / Ø 26 x H 14 cm	104.20

KÜCHENUTENSILIEN / USTENSILES DE CUISINE

Bain-Marie, quadratisch
Bain-Marie, carré

Inox 18/10, ohne Deckel, schwere Qualität
 Inox 18/10, sans couvercle, qualité lourde

Art-Nr./No d'article	Grösse/grandeur	Preis/prix
8006.04050	3,5 L/15,5x15,5 x H 16,0 cm	89.35
8006.04051	5,0 L/15,5x15,5 x H 23,5 cm	105.70

Zubehör/Accessoires

8006.04052	Deckel/Couvercle	29.35
-------------------	------------------	--------------

Salatschleuder
Essoreuse manuelle à salade

Korpus und Korbeinsatz aus Polypropylen, Deckel aus Polycarbonat, wird mit Wasserablaufschlauch geliefert, leichtes drehen der Kurbel durch zwei-stufig abgesetztes Getriebe.

Corps et panier en polypropylène, couvercle en polycarbonate, livrée avec tuyau d'évacuation d'eau moins d'effort sur la manivelle grâce à la démultiplication de l'engrenage.

Art-Nr./No d'article	Grösse/grandeur	Salate/salades	Preis/prix
8006.97100	Ø 37 x H 40 cm	2-3	282.30
8006.97101	Ø 46 x H 46 cm	4-5	298.85

Salatschleuder
Essoreuse manuelle à salade

Edelstahl satiniert und Kunststoff, ideal für Kleinküchen wie Kochschulen, Kindertagesstätten etc.
 Acier inoxydable satiné et plastique, idéal pour les petites cuisines telles que les écoles de cuisine, les garderies, etc.

Art-Nr./No d'article	Grösse/grandeur	Preis/prix
8102.14060	Ø 24 x H 16 cm	70.55

Salatschleuder
Essoreuse manuelle à salade

Polypropylen mit einer Mechanik aus Edelstahl und Polyamid, zum Abschleudern von Salat, Obst und Gemüse nach dem Waschen, Wasser läuft über einen Schlauch ab, innerer Korb entnehmbar
 Polypropylène avec une mécanique en acier inoxydable et polyamide, pour essorer la salade, les fruits et les légumes après les avoir lavés, évacuation de l'eau à l'aide d'un tuyau, panier intérieur amovible

Art-Nr./No d'article	Grösse/grandeur	Salate/salades	Preis/prix
8006.91910	Ø 32 x H 43 cm	2-3	195.25
8006.91911	Ø 43 x H 45 cm	4-5	223.45

Ersatzteile/Pièces de rechange

8006.91970	Getriebe Zahnrad klein Entraînement roue dentée petit 8006.91910+8006.19111	7.95
8006.91971	Perforiertes Zahnrad Roue dentée perforée 8006.91910+8006.19111	13.25
8006.91972	Perforiertes Zahnrad Roue dentée perforée 8006.91910+8006.19111	13.25
8006.91973	Innenbehälter klein Réceptacle intérieur petit 8006.91910	39.40
8006.91974	Innenbehälter gross Réceptacle intérieur grand 8006.19111	54.05
8006.91975	Aufsatz für Innenbehälter Embout pour réceptacle intérieur 8006.91910+8006.19111	19.95
8006.91976	Aussenbehälter klein Réceptacle extérieur petit 8006.91910	51.70
8006.91977	Aussenbehälter gross Réceptacle extérieur grand 8006.19111	58.80
8006.91978	Deckel komplett klein Couvercle complet petit 8006.91910	139.90
8006.91979	Deckel komplett gross Couvercle complet grand 8006.91911	161.15
8006.91980	Ablaufschlauch Tuyau d'écoulement 8006.91910+8006.19111	9.35

Zutatenbehälter
Réceptacle pour ingrédients

500 ml Inhalt pro Fach, 6 Fächer, inkl. Deckel (gefrostet) zur Lagerung
 6 compartiments de 500 ml chacun, avec couvercle pour le stockage

Art-Nr./No d'article	Grösse/grandeur	Preis/prix
8582.93171	50 x 16 x H 10 cm	34.65

Messbecher
Mesure

Polypropylen, milchig-transparent, mit eingepprägter Skala und blauem Sklaendruck, geschlossener Griff, hitzeresistent bis +125°C, unzerbrechlich, sterilisierbar
 Polypropylène, transparent laiteux, avec graduation gravée et impression bleue, poignée fermée, résistant jusqu'à +125°C, incassable, possibilité de stériliser

Art-Nr./No d'article	Grösse/grandeur	Preis/prix
8006.43210	0,25 L / Ø 7,0 x H 12,0 cm	4.45
8006.43211	0,50 L / Ø 9,0 x H 13,5 cm	4.65
8006.43212	1,00 L / Ø 11,5 x H 17,0 cm	6.95
8006.43213	2,00 L / Ø 15,5 x H 20,5 cm	11.70
8006.43214	3,00 L / Ø 17,0 x H 23,0 cm	14.80
8006.43215	5,00 L / Ø 20,0 x H 27,0 cm	19.15

«Stackable»
Messbecher
Pichet gradué

Polypropylen, mit offenem Griff und geprägter Massskalierung aussen, platzsparend stapelbar
 Polypropylène, avec une poignée ouverte et une échelle de dimensions en relief à l'extérieur, empilable et peu encombrante

8582.30061	Ø 9 cm, H 14 cm	4.65
8582.30062	Ø 12 cm, H 16,5 cm	6.30
8582.30063	Ø 15 cm, H 20,5 cm	10.55



**Massbecher
Mesure gradué**

Inox 18/10, graduert, stapelbar
Inox 18/10, graduée, empilable

Art-Nr./No d'article	Grösse/grandeur	Preis/prix
8006.43237	0,5 L / Ø 11,5 x H 11 cm	18.80
8006.43238	1,0 L / Ø 15,0 x H 13 cm	27.75
8006.43239	2,0 L / Ø 17,0 x H 19 cm	49.35



**Profi-Eimer
Seau professionnel**

Polyethylen, mit Ausgiesser und geprägter Massskalierung innen
Polyéthylène, avec bec verseur et échelle de mesure en relief à l'intérieur

8582.30075	Ø 28,5 cm, H 28,5 cm, 10,5 L	19.95
8582.30076	Ø 33 cm, H 32 cm, 17 L	27.75



**Profi-Eimer
Seau professionnel**

Polyethylen, mit Ausgiesser und geprägter Massskalierung innen
Polyéthylène, avec bec verseur et échelle de mesure en relief à l'intérieur

8582.30077	Ø 28,5 cm, H 28,5 cm, 10,5 L	19.95
8582.30078	Ø 33 cm, H 32 cm, 17 L	27.75



**Universalschaufel
Pelle universelle**

Inox 18/10
Inox 18/10

Art-Nr./No d'article	Grösse/grandeur	Preis/prix
8102.16181	5 cl / 4,5 x 8,5 x 18,0 cm	14.80
8102.16182	7 cl / 5,5 x 9,5 x 18,5 cm	17.40
8102.16183	14 cl / 6,5 x 12,0 x 21,0 cm	21.15
8102.16184	24 cl / 8,0 x 14,5 x 24,0 cm	25.40
8102.16185	30 cl / 9,0 x 16,0 x 25,0 cm	28.20
8102.16186	35 cl / 11,0 x 18,0 x 28,0 cm	32.30
8102.16187	45 cl / 11,0 x 19,0 x 30,0 cm	37.60

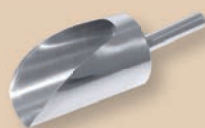

**Mehlschaufel
Pelle à farine**

Aus Edelstahl, hochglänzend, fugenlose Schaufel
En inox, poli brillant, pelle lisse

Art-Nr./No d'article	Grösse/grandeur	Preis/prix
8006.94001	Ø 7 cm x 16 cm	28.20
8006.94002	Ø 13 cm x 20 cm	35.15



**Mehlschaufel
Pelle à farine**

Aluminium
Aluminium

Art-Nr./No d'article	Grösse/grandeur	Preis/prix
8006.40050	11,0 cl / 18,5 cm	7.25
8006.40051	17,5 cl / 21,0 cm	8.90
8006.40052	30,0 cl / 25,0 cm	11.70
8006.40053	41,0 cl / 26,5 cm	16.40
8006.40054	65,0 cl / 31,0 cm	19.15
8006.40055	110,0 cl / 35,0 cm	27.75
8006.40056	187,0 cl / 40,0 cm	39.95
8006.40057	258,0 cl / 43,0 cm	56.40



**Mehlschaufel
Pelle à farine**

Polypropylen
Polypropylène

Art-Nr./No d'article	Grösse/grandeur	Preis/prix
8006.43232	10,0 cl / 11,5 cm	5.50
8006.43233	25,0 cl / 15,5 cm	6.10
8006.43234	50,0 cl / 19,5 cm	8.45
8006.43235	100,0 cl / 25,0 cm	11.25



**Trichter
Entonnoir**

Inox 18/10
Inox 18/10

Art-Nr./No d'article	Grösse/grandeur	Preis/prix
8006.40072	Ø 12 cm x H 14 cm	29.35
8006.40073	Ø 14 cm x H 17 cm	35.15
8006.40074	Ø 16 cm x H 17 cm	43.50
8006.40075	Ø 18 cm x H 18 cm	46.90
8006.40076	Ø 20 cm x H 20 cm	51.70
8006.40077	Ø 25 cm x H 26 cm	63.50
8006.40078	Ø 30 cm x H 33 cm	91.60



**Trichter
Entonnoir**

Polypropylen
Polypropylène

Art-Nr./No d'article	Grösse/grandeur	Preis/prix
8006.43220	Ø 8 cm	2.20
8006.43221	Ø 10 cm	3.25
8006.43222	Ø 12 cm	3.45
8006.43223	Ø 15 cm	4.65
8006.43224	Ø 18 cm	8.20



**Einmachtrichter
Etonnoir**

Aus gelbem Polypropylen, spülmaschinengeeignet, zum Abfüllen von z.B. Marmeladen in Gefässe mit Öffnung von 49, 66 und 82 mm
En polypropylène jaune, lavable au lave-vaisselle, pour l'embouteillage de verres de 49, 66 ou 82 mm

Art-Nr./No d'article	Grösse/grandeur	Preis/prix
8500.20235	Ø 4 cm x H 5,5 cm	6.10

KÜCHENUTENSILIEN / USTENSILES DE CUISINE

**«Profi»
Trichter
Entonnoir**

Polyethylen, mit Öse
Polyéthylène, avec œillet

8582.30065	Ø 6 cm, H 8 cm	1.95
8582.30066	Ø 8 cm, H 11 cm	2.20
8582.30067	Ø 10 cm, H 12 cm	2.30
8582.30068	Ø 12 cm, H 12 cm	3.40
8582.30069	Ø 14 cm, H 15 cm	6.80

**«Profi»
Trichter
Entonnoir**

Polyethylen, mit Öse und einsetzbarem Sieb
Polyéthylène, avec œillet, avec filtre insérable

8582.30070	Ø 17 cm, H 17 cm	9.35
8582.30071	Ø 21 cm, H 20 cm	12.50

**Quetschflasche, 6er Set
Bouteille verseuse souple, set de 6**

Polyethylen, mit Schraubdeckel und Verschluss-
kappe, ideal für Dressing und Saucen
Polyéthylène, avec couvercle à visser et bouchon
de fermeture, idéal pour vinaigrette et sauces

Art-Nr./No d'article	Grösse/grandeur	Preis/prix
8582.93250	26 cl / Ø 5 x H 18 cm	11.70/Set
8582.93251	26 cl / Ø 5 x H 18 cm	11.70/Set
8582.93252	26 cl / Ø 5 x H 18 cm	11.70/Set (1.95 p.pc)
8582.93253	49 cl / Ø 7 x H 20 cm	16.80/Set
8582.93254	49 cl / Ø 7 x H 20 cm	16.80/Set
8582.93255	49 cl / Ø 7 x H 20 cm	16.80/Set (2.80 p.pc)
8582.93256	76 cl / Ø 7 x H 26,5 cm	19.15/Set
8582.93257	76 cl / Ø 7 x H 26,5 cm	19.15/Set
8582.93258	76 cl / Ø 7 x H 26,5 cm	19.15/Set (3.19 p.pc)



Automatisches Schliessventil
Beschreibungsfeld
Ergonomisch
Label permanent
Ergonomique
Valve de fermeture

**Saucen-Dosierflaschen
Doseur de sauces**

weiss/blanc		
Art-Nr./No d'article	Grösse/grandeur	Preis/prix
8310.00611	Ø 60 mm / 35 cl	4.45
8310.00612	Ø 60 mm / 50 cl	5.15
8310.00613	Ø 75 mm / 75 cl	6.80

rot/rouge		
Art-Nr./No d'article	Grösse/grandeur	Preis/prix
8310.00621	Ø 60 mm / 35 cl	4.45
8310.00622	Ø 60 mm / 50 cl	5.15
8310.00623	Ø 75 mm / 75 cl	6.80

**Saucendispenser-Organiser
Organisateur de doseurs**

inkl 1 Flasche (75 cl)
incl 1 doseur (75 cl)

Art-Nr./No d'article	Grösse/grandeur	Preis/prix
8310.00635	GN 1/2, H 100 mm	46.90

**Mini-Auflaufform mit Grillgitter
Plat avec Grille**

Inox, Ideal zum Beiseitestellen oder Abtropfen-
lassen von Fleisch oder anderen Zutaten in der
Küche. Praktisch für schnelles und gesundes
Garen im Ofen.

*Inox, idéal pour réserver ou égoutter vos viandes
ou autres ingrédients en cuisine. Pratique pour
une cuisson au four rapide et diététique.*

Art-Nr./No d'article	Grösse/grandeur	Preis/prix
8006.90788	20,5 x 15 cm x H 30 cm	19.95
8006.90789	23,5 x 19 cm x H 35 cm	23.35

**MICROPLANE «Black Sheep»
Premium Zesto Reibe
Premium zesteur râpe**

Art-Nr./No d'article	Grösse/grandeur	Preis/prix
8006.42419	31 x 4,5 x 1,5 cm	61.15

**MICROPLANE «Black Sheep»
Raspel, grobe Schneide
Râpe, gros grains**

Art-Nr./No d'article	Grösse/grandeur	Preis/prix
8006.42418	30 x 6,8 x 30 cm	70.55

**MICROPLANE «Black Sheep»
Raspel, mittelgrosse Schneide
Râpe, double tranchant moyenne**

Art-Nr./No d'article	Grösse/grandeur	Preis/prix
8006.42417	30 x 6,8 x 30 cm	70.55

**MICROPLANE «Black Sheep»
Reibe, feine Schneide
Râpe, fins grains**

Art-Nr./No d'article	Grösse/grandeur	Preis/prix
8006.42416	30 x 6,8 x 30 cm	70.55

**MICROPLANE «Black Sheep»
Raspel, sehr grosse Schneide
Râpe, très gros grains**

Art-Nr./No d'article	Grösse/grandeur	Preis/prix
8006.42415	30 x 6,8 x 30 cm	70.55



**MICROPLANE «Professional»
Premium Zesto Reibe
Premium zesteur râpe**

für Käse, Zitrusfrüchte, Ingwer, Muskatnuss, etc.
pour le fromage, les agrumes, le gingembre, la noix de muscade, etc.

Art-Nr./No d'article	Grösse/grandeur	Griff/manche	Preis/prix
8006.42408	2,6 x 20,5 cm	12 cm	35.15



**MICROPLANE «Gourmet»
Raspel, grobe Schneide
Râpe, gros grains**

Art-Nr./No d'article	Grösse/grandeur	Preis/prix
8006.42425	31,2 x 7,5 x 3 cm	42.30



**MICROPLANE «Gourmet»
Raspel, mittelgrosse Schneide
Râpe, double tranchant moyenne**

Art-Nr./No d'article	Grösse/grandeur	Preis/prix
8006.42426	31,2 x 7,5 x 3 cm	42.30



**MICROPLANE «Gourmet»
Reibe, feine Schneide
Râpe, fins grains**

Art-Nr./No d'article	Grösse/grandeur	Preis/prix
8006.42428	31,2 x 7,5 x 3 cm	42.30



**MICROPLANE «Gourmet»
Reibe, grosse Raspel
Râpe, coupe large**

Art-Nr./No d'article	Grösse/grandeur	Preis/prix
8006.42429	31,2 x 7,5 x 3 cm	42.30



**MICROPLANE «Gourmet»
Reibe, feine Julienne
Râpe, julienne fine**

Art-Nr./No d'article	Grösse/grandeur	Preis/prix
8006.42427	31,2 x 7,5 x 3 cm	42.30



**MICROPLANE «Gourmet»
Gourmethobel
Mandoline gourmet**

Art-Nr./No d'article	Grösse/grandeur	Preis/prix
8006.42430	31,2 x 7,5 x 3 cm	42.30

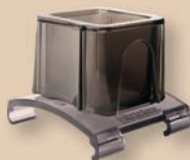

**«Microplane Professional»
Fingerschutz für Serie Professional
Glissoir protecteur pour serie prof.**

Art-Nr./No d'article	Grösse/grandeur	Preis/prix
8006.42406	6,5 x 6,5 cm	11.70



**«Microplane Professional»
Schutz-Handschuh
Gants de protection**

Geeignet für Rechts- und Linkshänder
Gant résistante aux coupures

Art-Nr./No d'article	Preis/prix
8006.42407	32.90



**MICROPLANE
Vierkant-Multifunktionsreibe
Râpe à 4 faces**

3 Klingen: sehr grob, fein, mittelgross + Hobel
3 lames: très gros grains, fine, moyen + mandoline

Art-Nr./No d'article	Grösse/grandeur	Preis/prix
8006.42409	12 x 8,5 cm x H 27,5 cm	86.90

KÜCHENUTENSILIEN / USTENSILES DE CUISINE

Vierkantraffel
Râpe universelle

Inox 18/10
 Inox 18/10

Art-Nr./No d'article Grösse/grandeur Preis/prix
8006.91081 10 x 8 cm x H 23 cm **19.95**

Universal Gemüseraffel «Mandoline 1000»
Râpe à légumes universelle «Mandoline 1000»

Inox 18/10, zerlegbar ohne spez. Werkzeuge, inkl. 3 Schneidblöcke 3, 5 und 10 mm
 Inox 18/10, démontable sans outils spéciaux, y compris 3 blocs effileurs, 3, 5 et 10 mm

Art-Nr./No d'article Grösse/grandeur Preis/prix
8006.95927 36 x 12 cm **265.85**
8006.95928 Handschutz **56.40**
 Chariot protecteur

TRIANGLE
Gemüsehobel mit Restehalter
Mandoline triangle pour légumes

Edelstahl, Kunststoff
 Inox, plastique

Art-Nr./No d'article Grösse/grandeur Preis/prix
8006.42628 33x12,5cm **65.85**

Rohkostreibe grob
Râpe grosse à crudités

Art-Nr./No d'article Grösse/grandeur Preis/prix
8102.16142 30 x 11 cm **14.55**

Rohkostreibe fein
Râpe fine à crudités

Art-Nr./No d'article Grösse/grandeur Preis/prix
8102.16146 30 x 11 cm **14.55**

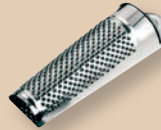
Muskattraffel
Râpe à muscade

Inox 18/10
 Inox 18/10

Art-Nr./No d'article Grösse/grandeur Preis/prix
8006.91080 14 x 4,3 cm **6.55**

«LE ROUET GOURMET»
Gemüseschneider
Coupe-légumes

Inox, Klinge austauschbar, verstellbar von 1mm bis 3,5mm, Schneidet Gemüse in dekorative Formen wie Spaghetti, flache Form oder Krausen.
 Lieferumfang: Klemme, 3 Klingen.

Inox. Porte-lames interchangeable. Réglage d'épaisseur de 1 mm à 3,5 mm. Appareil à couper les légumes original en spaghettis, tagliatelles ou guirlandes. Livré avec serre-joint et 3 couteaux.

Art-Nr./No d'article Grösse/grandeur Preis/prix
8006.96215 36 x 13,5 x H 24,3 cm **435.25**

Käsehobel Holz lackiert
Rabot à fromage

Plantagenholz Hevea
 hévéa plantation

Art-Nr./No d'article Grösse/grandeur Preis/prix
8020.00066 10 x 30 cm x H 8,5 cm **34.65**
8020.00067 15,5 x 35 cm x H 15 cm **50.55**

Käseschaber
Appareil à râcler le fromage

Art-Nr./No d'article Grösse/grandeur Preis/prix
8020.00065 Ø 22 cm **34.65**

Käsereiber
Râpe à fromage

Art-Nr./No d'article Grösse/grandeur Preis/prix
8102.15069 Ø 5 cm x 20 cm **36.95**

CUISIPRO
Käsereiber
Râpe à fromage

Art-Nr./No d'article Grösse/grandeur Preis/prix
8324.30015 20 cm **68.20**



Spätzliblech mit Stiel
Grille à Spätzli avec manche
Aluminium
Aluminium

Art-Nr./No d'article Grösse/grandeur Preis/prix
8102.17200 Ø 32 cm **115.85**



Knöpfli-/Spätzlisieb GN 1/1
Tamis à knöpfli/spätzli GN 1/1
Inox 18/10. Ausführung mit gelochter GN-Schale Tiefe 65 mm, sowie Rahmen zur Auflage auf Kippkessel.
Inox 18/10. Exécution avec récipient perforé GN et profondeur de 65 mm et un cadre à poser sur bassine inclinée.

Art-Nr./No d'article Grösse/grandeur Preis/prix
8006.21150 740 x 325 x 65 mm **489.35**



Passiergerät
Moulin passe-légumes
Inox 18/10, 1-1,5 Kg pro Minute, auf allen runden Töpfen ab 18 cm aufsetzbar, inkl. 3 Scheiben
Inox 18/10, rendement env. 1 à 1,5 kg/min, à placer sur tous les pots de diamètre 18 cm et plus, avec 3 différents disques

Art-Nr./No d'article Grösse/grandeur Preis/prix
8006.43246 Ø 32 cm x H 25 cm **272.90**



Pommes-Frites Schneider
Coupe-frite
inkl. Kartoffelgitter 8 x 8 mm (andere Gitter separat erhältlich), sauberer und einheitlicher Schnitt, geringer Kraftaufwand dank langem Hebel, Saugnäpfe zum Befestigen
avec grille de 8 x 8 mm (d'autres grilles sont disponibles séparément), coupe propre et homogène, demande peu de force grâce à un levier long, ventouse de fixation

Art-Nr./No d'article Grösse/grandeur Preis/prix
8270.35010 **822.30**

Kartoffelgitter separat
Grilles séparément
8270.35011 8 x 8 mm **173.95**
8270.35012 10 x 10 mm **173.95**
8270.35013 12 x 12 mm **173.95**



Kartoffelpresse
Presse pomme de terres
Inox 18/10, mit 2,5 mm-Lochung, kreuzgerändelter griffiger Hebel, extra schwere Ausführung mit zusätzliche Verstärkungstreben
Inox 18/10, perforation de 2,5mm, levier moleté maniable, exécution lourde avec renforcement supplémentaire

Art-Nr./No d'article Grösse/grandeur Preis/prix
8006.42226 10,5 x 10,5 x 33 cm **139.90**

Ersatzteile/Pièces de rechange
8006.42227 Ersatzhaltestift **4.95**
Goupille de retenue de remplacement



Zitruspresse
Presse-citron

Art-Nr./No d'article Grösse/grandeur Preis/prix
8102.18710 13 cm **33.50**



Apfel- und Zwiebelteiler
Coupe pomme et oignon
Inox 18/10, hochglänzend, Klingen aus gehärtetem, geschärftem Klingenstahl, geeignet für Früchte mit max. Ø 10 cm, extra schwere Qualität
Inox 18/10, poli brillant, lames en acier trempé et affilé, approprié pour fruits jusqu'à Ø 10 cm, qualité extra-lourde

Art-Nr./No d'article Grösse/grandeur Preis/prix
8006.42229 19,5 x H 5 cm **26.10**



Knoblauchpresse
Presse d'ail
aus PTFE-beschichtetem Aluminiumguss, mit patentiertem Verschlussystem, welches das schnelle Reinigen des Arbeitsteils unter fließendem Wasser ermöglicht, spülmaschinengeeignet
En fente aluminium pelliculé-PTFE, avec système d'arrêt patenté qui permet un lavage facile sous l'eau coulante, lavable au lave-vaisselle

Art-Nr./No d'article Länge/langueur Preis/prix
8006.94018 17,5 cm **21.85**



TRIANGLE
Knoblauchpresse und Schneider
Presse-ail et coupe-ail
Edelstahl
Inox

Art-Nr./No d'article Grösse/grandeur Preis/prix
8006.42629 19x3,3 cm **51.70**

KÜCHENUTENSILIEN / USTENSILES DE CUISINE



TRIANGLE
Hummerscherre/Zange
Pince à homard
Edelstahl, Kunststoff
Inox, plastique

Art-Nr./No d'article Länge/longueur Preis/prix
8006.42643 18,5 cm **82.10**



Hummerbrecher
Casse-homard

aus Aluminiumguss, zum Öffnen von Hummern und anderen Schalentieren, nicht spülmaschinengeeignet,
pour briser homards, langoustes et autres crustacés

Art-Nr./No d'article Grösse/grandeur Preis/prix
8006.42230 14 cm **6.30**



Eierteiler/Eierstückler
Coupe-œufs

Kunststoff weiss, Drähte Inox 18/10, für runde und ovale Scheiben sowie auch hochkant 6 gleiche Stücke
Synthétique blanc, fils tranchants en inox 18/10, pour tranches ou pour 6 morceaux égaux

Art-Nr./No d'article Grösse/grandeur Preis/prix
8006.90718 13,5 x 8,5 cm x H 4 cm **28.20**



«Columbus»
Eierstückler
Coupe-œufs

Aluminium, silbergrau, für 6 gleiche Stücke
Alu, gris-argent, pour portionner en 6 morceaux égaux

Art-Nr./No d'article Grösse/grandeur Preis/prix
8006.90701 18 x 6,5 cm x H 2,7 cm **28.20**



«Decoretto»
Radieschenschneider
Décor-radis

Aluminium kunststoffbeschichtet, silbergrau
Alu revêtement synthétique, gris-argent

Art-Nr./No d'article Grösse/grandeur Preis/prix
8006.90719 18 x 5 cm x H 3 cm **34.65**



«Olivus»
Olivenentsteiner
Dénoyauteur d'olives

Aluminium beschichtet, silbergrau
Alu revêtu, gris-argent

Art-Nr./No d'article Grösse/grandeur Preis/prix
8006.90707 17,5 x 10 cm x H 5 cm **28.20**



«Kernex»
Kirschentsteiner
Dénoyauteur à cerises

aus Gussaluminium, mit spülmaschinenfester Spezialbeschichtung
En fonte d'aluminium, revêtement aluminium spécialement conçu pour le lave-vaisselle

Art-Nr./No d'article Länge/longueur Preis/prix
8006.05010 14,4 cm **19.75**



Hamburgerpresse
Presse d'hamburger
Aluminium, Kunststoffgriff
Alu, manche plastique

Art-Nr./No d'article Grösse/grandeur Preis/prix
8006.94019 11,5 x 8 cm **22.95**



Fleischhaken
Crochet à viande

1 Spitze, Inox 18/10
1 pointe, inox 18/10

Art-Nr./No d'article	Ø	Länge/longueur	Preis/prix
8006.80422	3 mm	8 cm	1.05
8006.80423	4 mm	10 cm	1.15
8006.80424	5 mm	12 cm	1.60
8006.80425	5 mm	14 cm	1.75
8006.80426	6 mm	16 cm	2.20
8006.80427	6 mm	18 cm	2.55



Fleischhaken
Crochet à viande

2 Spitzen, Inox 18/10
2 pointes, inox 18/10

Art-Nr./No d'article	Ø	Länge/longueur	Preis/prix
8006.80450	3 mm	6 cm	0.90
8006.80451	4 mm	8 cm	1.40
8006.80452	4 mm	10 cm	1.50
8006.80453	5 mm	12 cm	1.75
8006.80454	5 mm	14 cm	1.85
8006.80455	6 mm	16 cm	2.30
8006.80456	6 mm	18 cm	3.45
8006.80457	9 mm	20 cm	5.85
8006.80458	9 mm	22 cm	6.10



KISAG
Universaldosenöffner
Ouvre-boîtes universel

Art-Nr./No d'article Ausführung/qualité Preis/prix
8006.95056 schwarz/noir **15.25**



**KISAG «Bonzer Eaziclean®»
Dosenöffner
Ouvre-boîtes**

Schnelles, einfaches und sicheres Öffnen...
Ohne Kraftaufwand lassen sich alle Arten von Dosen einfach und bequem öffnen, egal ob rund, eckig, oval oder verbeult. Die spezielle Geometrie des Öffnungsmechanismus verhindert die Entstehung von Metallspänen und scharfen Rändern und vermindert somit die Verletzungsgefahr. Stab, Abdeckung, Messer und Zahnrad Ø 25 mm ganz in Edelstahl, Handkurbel und Messerblock aus glasfaserverstärktem Kunststoff.
Ouverture rapide, facile et sûre... Toutes les boîtes, qu'elles soient ovales, rondes, carrées ou cabossées, s'ouvrent sans effort, très simplement. La géométrie spéciale du mécanisme d'ouverture évite la formation de copeaux de métal ou de bords acérés et diminue ainsi le risque de blessures. Tige, cache, couteau et pignon Ø 25 mm, en inox, manivelle et bloc couteau en plastique renforcé avec de la fibre de verre.

Art-Nr./No d'article	Grösse/grandeur	Dosen/boîte	Preis/prix
8006.95381	41 cm	H 36 cm	234.05
8006.95380	64 cm	H 56 cm	249.35

Ersatzteile/Pièces de rechange

- 

8006.95401 Messer inox
Couteau en inox **25.85**
- 

8006.95410 Schraube für Messer
Vis pour couteau **10.55**
- 

8006.95402 Zahnrad 25 mm
Pignon 25 mm **24.90**
- 

8006.95411 Abdeckung inox
Cache en inox **117.25**
- 

8006.95412 Klemmbügel inox
Virole en inox **46.90**



**Abrollvorrichtung
Dérouleur de film**

aus pulverbeschichtetem Stahlblech, mit Standfüssen als auch mit zwei Bohrungen für Wandbefestigung, mit Abreissäge, zum Einspannen von Rollen mit 45 cm breiter Folie, Backpapier oder Reinigungstüchern
de tôle d'acier peint par poudrage, avec piètement, fixation murale possible, approprié pour rouleaus jusqu'à 45 cm.

Art-Nr./No d'article	Grösse/grandeur	Preis/prix
8006.42228	49 x 19 cm x H 9 cm	90.45



**Folienabreissgerät
Dérouleur de film**

Inox 18/10
Inox 18/10

Art-Nr./No d'article	Länge/longueur	Preis/prix
8006.91807	30 cm	319.95
8006.91808	45 cm	376.40



**Wandregal für Kochutensilien
Etagère murale suspensoir à ustensiles**

Zum Verstauen von Töpfen, Pfannen, Kochutensilien usw., obere Abstellfläche für grosses Geschirr, an der Unterseite Hängeschienen und Haken für Kasserollen, Pfannen, Schöpflöffel, Schaumlöffel usw. Belastbar mit 50 kg.
Pour le stockage en cuisine: batteries de cuisine, poêles, ustensiles etc., une surface de stockage sur le dessus pour poser les articles volumineux, des barres de suspension et crochets en partie inférieure pour casseroles, poêles, louches, écumaies etc. résistent à 50 kg

Art-Nr./No d'article	Grösse/grandeur	Preis/prix
8006.90885	80 x 40 cm	388.20
8006.90886	120 x 40 cm	469.35



**Küchenleiste
Tringle de cuisine**

Monoblock-Leiste aus rostfreiem Stahl zur Aufhängung von Utensilien mit Haken und Löchern, Befestigung mit Edelstahlschrauben je nach Wandbeschaffenheit
Tringle en acier inoxydable monobloc pour ustensiles à crochets à trous de suspension, fixation par vis inox non fournies, à adapter en fonction du support

Art-Nr./No d'article	Länge/longueur	Haken/crochets	Preis/prix
8006.90887	50 cm	5	39.95
8006.90888	100 cm	8	65.85



**Bonleiste
Porte-bons**

Inox 18/10, mit Kugel-Greifsystem, schwere Qualität
Inox 18/10, avec système de billes glissantes, qualité lourde

Art-Nr./No d'article	Länge/longueur	Preis/prix
8006.40447	31 cm	8.90
8006.91805	46 cm	10.55
8006.91806	61 cm	12.35



**Bonschiene Inox
Porte-bons inox**

Art-Nr./No d'article	Grösse/grandeur	Preis/prix
8102.12350	50 cm	34.65

KÜCHENUTENSILIEN / USTENSILES DE CUISINE

**KISAG «Whipper Classic»
Bläser
Emulsionneur**

Edelstahl, nur für kalte Anwendungen, herausnehmbares Edelstahlventil, Kunststoffdichtung, komplett spülmaschinengeeignet, inkl. 2 Garniertüllen, Reinigungsbürstchen und Rezeptideen

Acier inoxydable, pour applications à froid uniquement, valve amovible en inox, joint en plastique, entièrement lavable au lave-vaisselle, avec 2 douilles de garniture, brosse de nettoyage et idées de recettes

Art-Nr./No d'article	Grösse/grandeur	Preis/prix
8006.95510	0,5 L / Ø 8 cm x H 24 cm	152.90

Zubehör/Accessoires

8006.95922	Bläser-Kapseln 50 stk Capsules chantilly 50 pce	62.30
-------------------	--	--------------

**KISAG «Whipper Professional»
Bläser
Emulsionneur**

Edelstahl, für kalte und warme Anwendungen, fest verbautes und verdrehsicheres Auslassventil, silikondichtung, komplett spülmaschinengeeignet, inkl. 3 Garniertüllen, Reinigungsbürstchen und Rezeptideen

Acier inoxydable, pour applications froides et chaudes, valve de sortie installés de manière permanente, et joint en silicone, entièrement lavable au lave-vaisselle, avec 3 douilles de garniture, brosse de nettoyage et idées de recettes

Art-Nr./No d'article	Grösse/grandeur	Preis/prix
8006.95520	0,5 L / Ø 8 cm x H 24 cm	163.50
8006.95530	1,0 L / Ø 9,5 cm x H 30 cm	185.85

Zubehör/Accessoires

8006.95922	Bläser-Kapseln 50 stk Capsules chantilly 50 pce	62.30
-------------------	--	--------------

**KISAG «Whipper Thermo»
Bläser
Emulsionneur**

Edelstahl, doppelwandig und vakuumisoliert, für kalte und warme Anwendungen, fest verbautes und verdrehsicheres Auslassventil, silikondichtung, komplett spülmaschinengeeignet, inkl. 3 Garniertüllen, Reinigungsbürstchen und Rezeptideen

Acier inoxydable, avec double paroi et isolé sous vide, pour applications froides et chaudes, valve de sortie installée de manière permanente, joint en silicone, entièrement lavable au lave-vaisselle, avec 3 douilles de garniture, brosse de nettoyage et idées de recettes

Art-Nr./No d'article	Grösse/grandeur	Preis/prix
8006.95540	0,5 L / Ø 8 cm x H 24 cm	218.80

Zubehör/Accessoires

8006.95922	Bläser-Kapseln 50 stk Capsules chantilly 50 pce	62.30
-------------------	--	--------------

**KISAG
Trichter und Sieb
Entonnoir inox avec tamis**

Edelstahl, Siebeinsatz 0,5 mm Maschenweite, für ein sauberes und bequemes Passieren direkt in die Edelstahlflasche, spülmaschinengeeignet
Acier inoxydable, tamis à mailles de 0,5 mm, pour un passage propre et pratique directement dans la bouteille en inox, lavable au lave-vaisselle

Art-Nr./No d'article	Grösse/grandeur	Preis/prix
8006.95946	75 cl / Ø 15 cm	64.65

**KISAG
Dekorationstüllen Set
Set de douilles deco**

Polypropylen transparent mit Adapter, 3-teilig, Rohr-, Würfel- und Rosentülle
Polypropylène transparent avec adaptateur, 3 pcs, décoration ronde, cube et rose

Art-Nr./No d'article	Preis/prix
8006.95962	29.35

**KISAG
Edelstahltüllen Set
Set de douilles en inox**

Edelstahl, 3-teilig, Tulpen-, Stern- und Lochtülle
Inox, 3 pcs, douille tulipe, étoile et tube

Art-Nr./No d'article	Preis/prix
8006.95963	29.60/Set

**KISAG «Fill-it»
Nadeltüllen Set
Set douilles**

Edelstahl, 2 lange und 2 kurze Nadeltüllen mit je Ø 3 mm und Ø 5 mm, inkl. 4 Schutzhüllen
Acier inoxydable, 2 aiguilles d'injection longues et 2 courtes, Ø 3 mm et Ø 5 mm, avec capuchons de protection

Art-Nr./No d'article	Grösse/grandeur	Preis/prix
8006.95980	Ø 3 mm + 5 mm	35.15/Set

**KISAG
Rapid Infusion Set
Set infusion rapide**

5-teilig, Siebträger, Sieb, Entlüftungs-, Silikonrohr, Reinigungsbürste, für Kalt- und Warmanwendungen, spülmaschinengeeignet
5 pcs, porte-tamis, tamis, tube de ventilation, tube silicon, brosse, pour applications froides et chaudes

Art-Nr./No d'article	Preis/prix
8006.95964	42.30/Set

**KISAG
Hitzeschutz
Chaleur protection**

100 % Silikon, schützt die Hände beim Anfassen der Kisag Edelstahl Bläserflaschen bei Warmanwendungen.

100% silicone, protège les mains lors de la manipulation des émulsionneurs en acier inox Kisag chauds.

Art-Nr./No d'article	Grösse/grandeur	Preis/prix
8006.95981	0,5 L	9.85
8006.95982	1,0 L	9.85

KISAG «Whipper»
Ersatzteile/Pièces de rechange



2365.001 Classic 123.50
Whipper-Kopf komplett
Whipper-tête compl.

2364.001 Professional/Thermo 152.90
Whipper-Kopf komplett
Whipper-tête compl.



2205.001 Classic 28.90
Ventil-Spindel
Valve de sortir



2234.001 Classic 10.55
Flaschendichtung
Joint de bouteille



2290.001 Professional/Thermo 13.25
Kopfdichtung, rot
Joint de la tête, rouge



2306.001 Classic 11.25
Garniertülle, perlmutt Inox
Douille, nacrée inox

2292.001 Professional/Thermo 11.25
Garniertülle Standard, rot Inox
Douille standard, rouge inox



2310.001 Classic 11.25
Garniertülle Tulpe, perlmutt
Douille tulipe, nacrée

2293.001 Professional/Thermo 11.25
Garniertülle Tulpe, rot Inox
Douille tulipe, rouge inox



2316.001 Professional/Thermo 13.95
Garniertülle gerade Edelstahl
Douille droite en inox



2210.001 Classic/Professional/Thermo 7.50
Kapselhalter Kisag
Pousse capsule kisag



2236.001 Classic/Professional/Thermo 6.10
Reinigungsbürstchen
Brosse de nettoyage



**KISAG «iSi Thermo-XPress Whip»
Bläser
Emulsionneur**

Inox, Standgerät mit Thermo-Effekt, innovatives Steigrohrsystem, doppelwandige vakumisolierte Flasche mit maximaler Thermoleistung, mit rutschfestem Untersetzer mit integrierter Tropfschale, Inox-Garniertülle
Inox, appareil à table avec effet thermique, tube d'aspiration innovant, bouteille isolée par un double paroi performance garantissant une isolation thermique maximale, tasse anti glissante anti-goûtes, douille en inox

Art-Nr./No d'article Grösse/grandeur Preis/prix
8006.95943 1,0 L / Ø 11,5 cm x H 35 cm **351.70**

Zubehör/Accessoires
8006.95922 Bläser-Kapseln 50 stk **62.30**
Capsules chantilly 50 pce



**KISAG
Bläser Kapseln
Capsules chantilly
N²O Einwegkapseln
Capsules jetables N²O**

Art-Nr./No d'article Preis/prix
8006.95922 50 Stück / Set à 50 pce. **62.30**



**KISAG
Vermicelle-Press
Presse à vermicelles**
Inox 18/10
Inox 18/10

Art-Nr./No d'article Grösse/grandeur Preis/prix
8006.95900 22 x 6,9 cm **218.80**

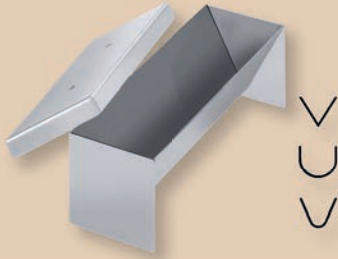

KÜCHENUTENSILIEN / USTENSILES DE CUISINE

Pastetenform mit Deckel
Forme de friand avec couvercle

Edelstahl, hochglänzend, Materialstärke 0,9 mm, Bodenabstand ca. 1 cm, schwere Qualität
 En inox, poli brillant, épaisseur de matière 0,9 mm, distance au sol env. 1 cm, qualité lourde

Art-Nr./No d'article	Grösse/grandeur	Preis/prix
8006.94010	Dreieck spitz/Triangle aigu 26 x 8 x 7,5 cm 0,7 L	43.50
8006.94011	Halbrund/hémicycle 26 x 8,5 x 7,5 cm 1,0 L	43.50
8006.94012	Klassisch/classique 26 x 8,5 x 7,5 cm 0,7 L	43.50

Pastetenform mit Deckel
Forme de friand avec couvercle

Edelstahl, hochglänzend, gerade Kastenform, Materialstärke 0,9 mm, schwere Qualität
 En inox, poli brillant, épaisseur de matière 0,9 mm, qualité lourde

Art-Nr./No d'article	Grösse/grandeur	Preis/prix
8006.94013	30 x 7-8 x H 7 cm	56.40

Pastetenform mit Deckel
Forme de friand avec couvercle

Edelstahl, hochglänzend, Materialstärke 0,9 mm, Bodenabstand ca. 0,5 cm, schwere Qualität
 En inox, poli brillant, épaisseur de matière 0,9 mm, distance au sol env. 0,5 cm, qualité lourde

Art-Nr./No d'article	Grösse/grandeur	Preis/prix
8006.94014	Dreieck spitz/Triangle aigu 50 x 10 x 9 cm 2,0 L	98.55
8006.94015	Halbrund/hémicycle 50 x 10 x 9 cm 3,5 L	91.60

Pastetenform mit Deckel
Forme de friand avec couvercle

Edelstahl, hochglänzend, Materialstärke 0,9 mm, Bodenabstand ca. 1 cm, schwere Qualität
 En inox, poli brillant, épaisseur de matière 0,9 mm, distance au sol env. 1 cm, qualité lourde

Art-Nr./No d'article	Grösse/grandeur	Preis/prix
8006.94016	Halbrund/hémicycle 27,5 x 5,5 x 5 cm 0,5 L	41.15

Portionsdachrinne
Chéneau de portion

Aus Edelstahl 18/10, hochglanzpoliert
 Inox 18/10, poli brillant

Art-Nr./No d'article	Grösse/grandeur	Inhalt/capacité	Preis/prix
8006.94017	13,5 x 4 x 4,5 cm	0,16 L	25.85

Biskuitrollenform
Gouttière à bûche

Inox in wasserdichter Halbschalenform. Zum Formen von Mousses, Feinkostgelees, Eisrollen und vieles mehr.
 Inox, demi-ronde, étanche. Utilisable pour le moulage des mousses, produits traiteur en gelée, bûches glacées, etc...

Art-Nr./No d'article	Grösse/grandeur	Preis/prix
8006.90874	35 x 6 x H 4,5 cm	51.70

Dreieckform
Gouttière triangulaire

Inox, 1 mm dick. Wasserdicht zur Zubereitung und zum Backen von Mousses und Terrinen.
 Inox, épaisseur 1 mm. Fabrication étanche pour la réalisation et la cuisson de mousses et de terrines.

Art-Nr./No d'article	Grösse/grandeur	Preis/prix
8006.90876	50 x 9 x H 7,5 cm	62.30

Biskuitform
Gouttière

Polystyrol, wasserdicht, geeignet für Eisrollen.
 Polystyrène, étanche. Convient pour les bûches glacées.

Art-Nr./No d'article	Grösse/grandeur	Preis/prix
8006.90870	Halbrund/hémicycle 47 x 6,5 x H 7 cm	33.50
8006.90871	Halbrund/hémicycle 47 x 6,5 x H 4 cm	33.50
8006.90872	Dreieck/Triangle 47 x 6,5 x H 7 cm	33.50
8006.90873	geschweift/à côtes 47 x 6,5 x H 7 cm	33.50

SCHNEIDEBRETT / PLANCHES À DECOUPER

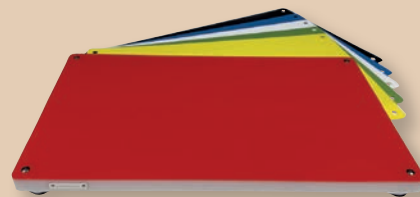

«Profboard» Basisbrett inkl. 6 Schneidblätter Modèle de base incl. 6 plaques

Patentiertes Schneidebrett ermöglicht ein sauberes, hygienisches und sicheres Arbeiten. Mit dem genialen Click System können die verschiedenen farbigen Auflagen einfach gewechselt werden. Sie sind geruchsneutral, lebensmittelecht und können bei 95 Grad in der Spülmaschine gereinigt werden. Ein weiterer Vorteil ist, dass die Messer nicht stumpf werden. Die verschiedenen farbigen Auflagen sind aus einem speziellen PP-Material und werden in verschiedenen Farben hergestellt, um sie nach HACCP-System nutzen zu können. Inkl. 6 Schneidblätter (weiss, blau, grün, gelb, schwarz, rot)

La planche à découper brevetée permet un travail propre, hygiénique et sûr. Grâce à l'ingénieux «système de clic», les différentes plaques de couleur peuvent être facilement changées. Elles sont inodores, sans danger pour les aliments et peuvent être nettoyées au lave-vaisselle à 95 degrés. Un autre avantage est que les couteaux ne s'émousent pas. Les différentes plaques colorées sont fabriquées dans un matériau PP spécial et sont produites en couleurs différentes afin de pouvoir être utilisés conformément au système HACCP. Inclus 6 plaques de découpe (blanc, bleu, vert, jaune, noir, rouge)

Art-Nr./No d'article	Grösse/grandeur	Preis/prix
8325.68000	GN 1/1 - 53 x 32,5 cm	149.80
8325.68001	40 x 60 cm	179.80



Tranchierbrett Planche à découper

aus Polyethylen, weiss
en Polyéthylène, blanc

Art-Nr./No d'article	Grösse/grandeur	Dicke/épaisseur	Preis/prix
8006.70015	16,0 x 24,5 cm	1 cm	9.85
8006.70016	24,5 x 32,5 cm	1 cm	16.40



Schneidbrett HACCP Planche à découper

Polyethylen, schwere Qualität, ideale Grösse für Kleinküchen wie Hauswirtschaft, Kinderkrippen, Gemeinschaftsküchen
Polyéthylène, qualité lourde, taille idéale pour les petites cuisines telles que écoles de cuisines, crèches, cuisines collectives

Art-Nr./No d'article	Grösse/grandeur	Preis/prix
8006.48501	34,5 x 24,5 x H 1 cm	17.95
8006.48502	34,5 x 24,5 x H 1 cm	17.95
8006.48503	34,5 x 24,5 x H 1 cm	17.95
8006.48504	34,5 x 24,5 x H 1 cm	17.95
8006.48505	34,5 x 24,5 x H 1 cm	17.95
8006.48506	34,5 x 24,5 x H 1 cm	17.95



Tranchierbrett Planche à découper

aus Polyethylen HD, weiss
en HD Polyéthylène, blanc

Art-Nr./No d'article	Grösse/grandeur	Dicke/épaisseur	Preis/prix
8006.70017	40 x 30 cm	2 cm	42.30
8006.70018	50 x 30 cm	2 cm	51.70
8006.70019	80 x 40 cm	2 cm	111.25



«Profboard» Ersatz-Schneidblätter Plaques de découpe de rechange

Art-Nr./No d'article	Grösse/grandeur	Preis/prix
8325.68101	GN 1/1	7.90
8325.68102	GN 1/1	7.90
8325.68103	GN 1/1	7.90
8325.68104	GN 1/1	7.90
8325.68105	GN 1/1	7.90
8325.68106	GN 1/1	7.90
8325.68107	GN 1/1	7.90
8325.68201	40 x 60 cm	8.50
8325.68202	40 x 60 cm	8.50
8325.68203	40 x 60 cm	8.50
8325.68204	40 x 60 cm	8.50
8325.68205	40 x 60 cm	8.50
8325.68206	40 x 60 cm	8.50
8325.68207	40 x 60 cm	8.50

SCHNEIDEBRETTER / PLANCHES À DECOUPER

GN-Hygienebretter mit Rille
Planches hygieniques avec rainure

 aus Polyethylen
 en Polyéthylène

	für Gemüse <i>pour légumes</i>
	für Backwaren <i>pour pâtisseries</i>
	für rohes Fleisch <i>pour viande crue</i>
	für gekochtes Fleisch <i>pour viande cuite</i>
	für Salat und Früchte <i>pour salade et fruits</i>
	für rohen Fisch <i>pour poisson cru</i>

Art-Nr./No d'article	Grösse/grandeur		Preis/prix
8006.70001	GN 1/2 - 20 mm		44.65
8006.70003	GN 1/1 - 20 mm		89.35
8006.70005	GN 1/1 - 30 mm		114.65
8011.71070	GN 2/1 - 20 mm		128.20
8006.70007	GN 2/1 - 30 mm		176.40
8006.70701	GN 1/2 - 20 mm		44.65
8006.70703	GN 1/1 - 20 mm		89.35
8006.70705	GN 1/1 - 30 mm		114.65
8011.71074	GN 2/1 - 20 mm		128.20
8006.70707	GN 2/1 - 30 mm		176.40
8006.71001	GN 1/2 - 20 mm		44.65
8006.71003	GN 1/1 - 20 mm		89.35
8006.71005	GN 1/1 - 30 mm		114.65
8011.71076	GN 2/1 - 20 mm		128.20
8006.71007	GN 2/1 - 30 mm		176.40
8006.71011	GN 1/2 - 20 mm		44.65
8006.71013	GN 1/1 - 20 mm		89.35
8006.71015	GN 1/1 - 30 mm		114.65
8011.71077	GN 2/1 - 20 mm		128.20
8006.71017	GN 2/1 - 30 mm		176.40
8006.71021	GN 1/2 - 20 mm		44.65
8006.71023	GN 1/1 - 20 mm		89.35
8006.71025	GN 1/1 - 30 mm		114.65
8011.71078	GN 2/1 - 20 mm		128.20
8006.71027	GN 2/1 - 30 mm		176.40
8006.71031	GN 1/2 - 20 mm		44.65
8006.71033	GN 1/1 - 20 mm		89.35
8006.71035	GN 1/1 - 30 mm		114.65
8011.71079	GN 2/1 - 20 mm		128.20
8006.71037	GN 2/1 - 30 mm		176.40

GN-Hygienebretter glatt
Planches hygieniques lisse

 aus Polyethylen
 en Polyéthylène

	für Gemüse <i>pour légumes</i>
	für Backwaren <i>pour pâtisseries</i>
	für rohes Fleisch <i>pour viande crue</i>
	für gekochtes Fleisch <i>pour viande cuite</i>
	für Salat und Früchte <i>pour salade et fruits</i>
	für rohen Fisch <i>pour poisson cru</i>

Art-Nr./No d'article	Grösse/grandeur		Preis/prix
8006.70000	GN 1/2 - 20 mm		38.20
8006.70002	GN 1/1 - 20 mm		76.20
8006.70004	GN 1/1 - 30 mm		107.60
8010.71058	GN 2/1 - 20 mm		114.65
8006.70006	GN 2/1 - 30 mm		163.50
8006.70700	GN 1/2 - 20 mm		38.20
8006.70702	GN 1/1 - 20 mm		76.20
8006.70704	GN 1/1 - 30 mm		107.60
8010.71062	GN 2/1 - 20 mm		114.65
8006.70706	GN 2/1 - 30 mm		163.50
8006.71000	GN 1/2 - 20 mm		38.20
8006.71002	GN 1/1 - 20 mm		76.20
8006.71004	GN 1/1 - 30 mm		107.60
8010.71064	GN 2/1 - 20 mm		114.65
8006.71006	GN 2/1 - 30 mm		163.50
8006.71010	GN 1/2 - 20 mm		38.20
8006.71012	GN 1/1 - 20 mm		76.20
8006.71014	GN 1/1 - 30 mm		107.60
8010.71065	GN 2/1 - 20 mm		114.65
8006.71016	GN 2/1 - 30 mm		163.50
8006.71020	GN 1/2 - 20 mm		38.20
8006.71022	GN 1/1 - 20 mm		76.20
8006.71024	GN 1/1 - 30 mm		107.60
8010.71066	GN 2/1 - 20 mm		114.65
8006.71026	GN 2/1 - 30 mm		163.50
8006.71030	GN 1/2 - 20 mm		38.20
8006.71032	GN 1/1 - 20 mm		76.20
8006.71034	GN 1/1 - 30 mm		107.60
8010.71067	GN 2/1 - 20 mm		114.65
8006.71036	GN 2/1 - 30 mm		163.50

 Beidseitig nutzbar
 Utilisable deux côtés

 Farbcode
 Code couleur

 Antirutsch-Ecken
 Angles anti-glisse

Schneidebrett
Planches à découper

 aus Polyethylen
 en Polyéthylène

 für Backwaren
pour pâtisseries
 für rohes Fleisch
pour viande crue
 für rohen Fisch
pour poisson cru
 für gekochtes Fleisch
pour viande cuite
 für Salat und Früchte
pour salade et fruits

Art-Nr./No d'article	Grösse/grandeur		Preis/prix
8310.00101	304 x 204 x 19 mm		28.20
8310.00102	404 x 304 x 24 mm		51.70
8310.00103	504 x 304 x 34 mm		96.20
8310.00104	604 x 404 x 24 mm		114.65
8310.00201	304 x 204 x 19 mm		28.20
8310.00202	404 x 304 x 24 mm		51.70
8310.00203	504 x 304 x 34 mm		96.20
8310.00204	604 x 404 x 24 mm		114.65
8310.00301	304 x 204 x 19 mm		28.20
8310.00302	404 x 304 x 24 mm		51.70
8310.00303	504 x 304 x 34 mm		96.20
8310.00304	604 x 404 x 24 mm		114.65
8310.00401	304 x 204 x 19 mm		28.20
8310.00402	404 x 304 x 24 mm		51.70
8310.00403	504 x 304 x 34 mm		96.20
8310.00404	604 x 404 x 24 mm		114.65
8310.00501	304 x 204 x 19 mm		28.20
8310.00502	404 x 304 x 24 mm		51.70
8310.00503	504 x 304 x 34 mm		96.20
8310.00504	604 x 404 x 24 mm		114.65

Brotschneidebrett
Planche à couper le pain

 aus Polyethylen, inkl. rutschhemmenden Füßchen
 en Polyéthylène, avec pieds anti-glissants

Art-Nr./No d'article	Grösse/grandeur	Preis/prix
8006.70800	60 x 35 cm x H 2 cm	223.45



**Abzieher für Polyethylenbretter
Racloir à planches Polyéthylène**

Wird wie ein Hobel benutzt. Beseitigt rasch Schnittkerben und Flecken, sodass die Arbeitsfläche immer glatt und makellos bleibt. Auswechselbare Wendeklinge aus gehärtetem Stahl.

Il s'utilise comme un rabot et permet de supprimer très rapidement les entailles et les taches de travailler sur une surface toujours lisse et impeccable. Lame interchangeable et réversible en acier trempé.

Art-Nr./No d'article	Grösse/grandeur	Preis/prix
8006.90766	20,2 cm	117.25

Ersatzteile/Pièces de rechange

8006.90767	Ersatzklinge 2 Stk. Lame de rechange 2 pcs.	56.40
-------------------	--	--------------



**Tranchierbretter-Halter
Support pour planche à découper**

aus Inox 18/10, für 6 Bretter bis 50 mm Stärke
En acier inoxydable 18/10, pour 6 planches jusqu'à 50 mm d'épaisseur

Art-Nr./No d'article	Grösse/grandeur	Preis/prix
8006.42313	43 x 32 cm x H 28 cm	64.65



**Wand-Schneidbretthalter
Support mural pour planche à découper**

aus Edelstahl, elektropolierter Draht (8 und 6 mm), für sieben Schneidbretter mit mindestens 30 cm Breite oder Deckel über 28 cm, sehr stabile Ausföhrung

En acier inoxydable, fil électropoli (8 et 6 mm), pour 7 planches à découper de minimum 30 cm de large ou des couvercles de plus de 28 cm, conception très stable

Art-Nr./No d'article	Grösse/grandeur	Preis/prix
8006.40546	29 x 28 cm x H 55 cm	92.80



**Hackblock aus Holz
Bloc de boucher en bois**

Block aus verleimter und verzahnter Weissbuche, ohne Spannreifen. Separat bestellen: Untergestell aus 40 mm Vierkantstahlrohr mit höhenverstellbaren Kunststoff-Füssen. Arbeitshöhe total ca. 85 cm
En charmeille collée et adentée. Commander séparément: châssis stable en tubes de métal carrés avec pieds réglable. Hauteur de travail de env. 85 cm

Hackblock aus Weissbuche ohne Edelstahlfuss
Bloc de boucher en charmeille sans châssis en inox

Art-Nr./No d'article	Grösse/grandeur	Preis/prix
8006.94021	40 x 40 cm x H 25 cm	694.00
8006.94023	50 x 50 cm x H 25 cm	1117.60

Edelstahlfuss für Holzhackblöcke
Châssis en inox pour blocs à pioches en bois

Art-Nr./No d'article	Grösse/grandeur	Preis/prix
8006.94025	40 x 40 cm x H 60 cm	564.65
8006.94027	50 x 50 cm x H 60 cm	694.00



**Hackblock aus Polyethylen
Bloc de boucher en polyéthylène**

Hackblock aus weissem HD-Polyethylen 500. Separat bestellen: Untergestell aus 40 mm Vierkantstahlrohr mit höhenverstellbaren Kunststoff-Füssen. Arbeitshöhe total ca. 85 cm.
Bloc en polyéthylène. Commander séparément: châssis stable en tubes de métal carrés avec pieds réglable. Hauteur de travail de env. 85 cm.

Hackblock aus Polyethylen ohne Edelstahlfuss
Bloc à pioche en polyéthylène sans châssis en inox

Art-Nr./No d'article	Grösse/grandeur	Preis/prix
8006.94060	40 x 40 cm x H 8 cm	351.70
8006.94061	50 x 50 cm x H 8 cm	576.40

Edelstahlfuss für Polyethylen-Hackblöcke
Châssis en inox pour blocs à pioches en polyéthylène

Art-Nr./No d'article	Grösse/grandeur	Preis/prix
8006.94062	40 x 40 cm x H 77 cm	670.50
8006.94063	50 x 50 cm x H 77 cm	741.15



**Hackblockbürste
Brosse de bloc à pioche**

mit flachen gehärteten Stahldrahtborsten, nicht rostfrei, Halteschlaufe und Griffplatte aus Kunststoff
avec soies de fil d'acier plates et trempées, ne pas inoxydable, passant et plat de manche en plastique

Art-Nr./No d'article	Grösse/grandeur	Preis/prix
8006.94028	19 x 7,5 cm	38.80



**VICTORINOX
Küchenhaubeil
Couperet**

Fibrox-Griff schwarz
Manche fibrox noir

Art-Nr./No d'article	Schnittlänge/tranchant		Preis/prix
8006.80733	18 cm	320 gr	68.20
8006.80734	18 cm	600 gr	114.65



**VICTORINOX
Fleischklopper
Battoir à viande**

Inox 18/10
Inox 18/10

Art-Nr./No d'article	Grösse/grandeur	Preis/prix
8006.80246	12 x 12 cm x H 28 cm	114.65

MESSER, SCHNEIDGERÄTE / COUTELLERIE



VICTORINOX
Gemüsemesser
Couteau d'office
gerader Schnitt
Lame droite

Art-Nr./No d'article	Schnittlänge/tranchant	Preis/prix
8006.80195	6 cm ■	4.90
8006.80196	6 cm ■	4.90



VICTORINOX
Gemüsemesser
Couteau d'office
gerader Schnitt
Lame droite

Art-Nr./No d'article	Schnittlänge/tranchant	Preis/prix
8006.80079	8 cm ■	5.15
8006.80091	8 cm ■	5.15



VICTORINOX
Tourniermesser
Couteau à tourner
gebogene Klinge
Lame courbe

Art-Nr./No d'article	Schnittlänge/tranchant	Preis/prix
8006.80197	6 cm ■	4.90
8006.80198	6 cm ■	4.90



VICTORINOX
Gemüsemesser
Couteau d'office
mittelspitz
Lame pointue

Art-Nr./No d'article	Schnittlänge/tranchant	Preis/prix
8006.80199	8 cm ■	5.15
8006.80049	8 cm ■	5.15



VICTORINOX
Gemüsemesser
Couteau d'office
mittelspitz
Lame pointue

Art-Nr./No d'article	Schnittlänge/tranchant	Preis/prix
8006.80081	10 cm ■	6.55
8006.80412	10 cm ■	6.55



VICTORINOX
Gemüsemesser
Couteau d'office
mittelspitz mit Wellenschliff
Lame pointue avec tranchant denté

Art-Nr./No d'article	Schnittlänge/tranchant	Preis/prix
8006.80413	10 cm ■	6.55
8006.80082	10 cm ■	6.55



VICTORINOX
Tomaten- und Wurstmesser
Couteau à tomates et saucisses
mit Wellenschliff
avec tranchant denté

Art-Nr./No d'article	Schnittlänge/tranchant	Preis/prix
8006.80094	11 cm ■	6.55
8006.80100	11 cm ■	6.55
8006.80930	11 cm ■	6.55



VICTORINOX «SwissClassic»
Steakmesser
Couteau à steak
Wellenschliff, PP-Griff schwarz
Tranchant denté, manche PP noir

Art-Nr./No d'article	Schnittlänge/tranchant	Preis/prix
8002.90022	22/11 cm	6.30



VICTORINOX
Käse- und Wurstmesser
Couteau à fromage et saucisses
 mit Gabelspitze, mit Wellenschliff
double pointe, tranchant denté

Art-Nr./No d'article Schnittlänge/tranchant Preis/prix
8006.80201 11 cm **6.55**



VICTORINOX
Sparschäler, einschneidig
Eplucheur à 1 tranchant
 für Rechtshänder
pour droitiers

Art-Nr./No d'article Preis/prix
8006.80075 ■ **6.55**
8006.80051 ■ **6.55**



VICTORINOX
Sparschäler, zweiseitig
Eplucheur à 2 tranchants
 für Links- und Rechtshänder
pour gauchers et droitiers

Art-Nr./No d'article Preis/prix
8006.80077 ■ **6.55**
8006.80053 ■ **6.55**



VICTORINOX «Rex»
Sparschäler
Eplucheur
 Aluminium, bewegliche Klinge
Aluminium, lame mobile

Art-Nr./No d'article Preis/prix
8006.80066 **7.50**



VICTORINOX
Sparschäler Kunststoff
Eplucheur plastique
 Kunststoff, bewegliche Klinge
plastique, lame mobile

Art-Nr./No d'article Preis/prix
8006.80000 ■ **4.10**
8006.80001 ■ **4.10**



Sparschäler Edelstahl
Eplucheur inox
 Edelstahl, ergonomisch, bewegliche Klinge
Inox, ergonomique, lame mobile

Art-Nr./No d'article Grösse/grandeur Preis/prix
161248100 15 x 6,5 cm **15.25**



VICTORINOX
Buntschneidmesser
Couteau à garnir
 Zahnung 4 mm flach
Denture légère 4 mm

Art-Nr./No d'article Schnittlänge/tranchant Preis/prix
8006.80144 9 cm **15.95**



VICTORINOX
Zitronendekormesser
Canneleur à citrons

Art-Nr./No d'article Preis/prix
8006.80931 **11.70**



TRIANGLE
Zieseliermesser rechteckig
Couteau à ciseler rectangulaire
 Edelstahl
Inox

Art-Nr./No d'article Länge/longueur Preis/prix
8006.42636 15,8 cm **10.55**



VICTORINOX
Zitronenschaber
Zesteur à citrons

Art-Nr./No d'article Preis/prix
8006.80932 **11.70**



TRIANGLE
Dekozeester
Zesteur/Canneleur
 Edelstahl
Inox

Art-Nr./No d'article Länge/longueur Preis/prix
8006.42637 15,6 cm **10.55**



VICTORINOX
Apfelausstecher
Vide-pommes

Art-Nr./No d'article Ø Preis/prix
8006.80360 16 mm **7.50**



Apfelentkerner
Dénoyauteur de pommes
 Edelstahl mit geschärften Rändern, Griff aus
 Nylon/Fiberglas
*Inox avec bords affûtés, manche en nylon/fibre
 de verre*

Art-Nr./No d'article Grösse/grandeur Preis/prix
8582.88836 21 cm **4.90**



TRIANGLE
Wellenschneider
Couteau à sculpter
 Edelstahl, Kunststoff
Inox, plastique

Art-Nr./No d'article Grösse/grandeur Preis/prix
8006.42630 9x9,5 cm **21.85**

MESSER, SCHNEIDGERÄTE / COUPELLERIE



TRIANGLE
Kugelformer, 10 mm
Cuillère à melon, 10 mm
Edelstahl
Inox

Art-Nr./No d'article	Länge/longueur	Preis/prix
8006.42633	15,4 cm	11.70



TRIANGLE
Kugelformer, 25 mm
Cuillère à melon, 25 mm
Edelstahl
Inox

Art-Nr./No d'article	Länge/longueur	Preis/prix
8006.42634	17,5 cm	13.95



TRIANGLE
Kugelformer, 30 mm
Cuillère à melon, 30 mm
Edelstahl, Kunststoff
Inox, plastique

Art-Nr./No d'article	Länge/longueur	Preis/prix
8006.42635	17,5 cm	15.25



Kugelausstecher doppelt
Découpoir-boule double

zum Formen von Kugeln aus Obst, Gemüse oder Butter, Edelstahl mit geschärften Rändern, Griff aus Nylon/Fiberglas
Pour former des boules en fruits, légumes ou beurre, inox avec bords affûtés, manche en nylon/fibre de verre

Art-Nr./No d'article	Grösse/grandeur	Ø	Preis/prix
8582.88811	17 cm	2,2 + 3,0 cm	11.25



Cocktailmesser
Couteau de cocktail

mit 2 Zinken zum Aufspiessen von Zitruscheiben, Griff aus Nylon/Fiberglas
Avec deux dents pour empaler des tranches d'agrumes, manche en nylon/fibre de verre

Art-Nr./No d'article	Grösse/grandeur	Preis/prix
8582.88846	21 cm	7.25



TRIANGLE
Austernmesser, genietet
Couteau à huîtres, riveté acier finacier fin
Edelstahl, Kunststoff
Inox, plastique

Art-Nr./No d'article	Länge/longueur	Preis/prix
8006.42642	16,3 cm	21.85



TRIANGLE
Kettenhandschuh
Gant en cotte maille
Edelstahl
Inox

Art-Nr./No d'article	Grösse/grandeur	Preis/prix
8006.42640	M	176.40
8006.42639	L	176.40



Trüffel-/Feinhobel
Râpe à truffe

aus Inox 18/10, mit stufenloser Einstellschraube und extra scharfer Klinge, schwere Qualität
en inox 18/10, réglage continu par vis, lame finement aiguisée, qualité lourde

Art-Nr./No d'article	Klinge/tranchant	Preis/prix
8006.91120	glatt/lisse	49.35
8006.91121	gewellt/ondulé	49.35



Trüffelhobel
Râpe à truffe
Olivenbaumholz
bois d'olivier

Art-Nr./No d'article	Preis/prix
8020.00068	66.95



VICTORINOX
Geflügelschere
Ciseaux à volailles
rostfrei, 25 cm, mit Pufferfeder
inoxydable, 25 cm, avec ressort comtois

Art-Nr./No d'article	Länge/longueur	Preis/prix
8006.80580	25 cm	57.60



VICTORINOX
Masticateur (Nahrungszerkleinerer)
Masticateur
verchromt, gebogen
chromé, courbé

Art-Nr./No d'article	Länge/longueur	Preis/prix
8006.80586	18 cm	107.60



Fischschere
Ciseaux à poissons
gezahnt, vernickelt
denté, nickelé

Art-Nr./No d'article	Preis/prix
8006.94080	32.30



Küchenschere
Ciseaux de cuisine
Hochwertiger Klingenstahl
Lame d'acier de grande qualité

Art-Nr./No d'article	Grösse/grandeur	Preis/prix
8102.15913	21,5 cm	28.20



Universalschere
Ciseaux universelle
Aus Klingenstahl
Faite en lame d'acier

Art-Nr./No d'article	Grösse/grandeur	Preis/prix
8102.15920	21 cm	11.70



VICTORINOX
Officemesser, geschmiedet
Couteau d'office, forgés
 POM-Griff schwarz
 Manche POM noir

Art-Nr./No d'article	Schnittlänge/tranchant	Preis/prix
8006.80720	8 cm	65.85
8006.80721	10 cm	74.95



VICTORINOX
Tranchiermesser, geschmiedet
Couteau à découper, forgés
 POM-Griff schwarz
 Manche POM noir

Art-Nr./No d'article	Schnittlänge/tranchant	Preis/prix
8006.80722	15 cm	96.20
8006.80723	20 cm	109.85



VICTORINOX
Filetmesser, geschmiedet
Couteau à fileter, forgés
 POM-Griff schwarz, flexible Klinge
 Manche POM noir, lame flexible

Art-Nr./No d'article	Schnittlänge/tranchant	Preis/prix
8006.80724	20 cm	109.85



VICTORINOX
Tourniermesser, geschmiedet
Couteau à tourner, forgés
 POM-Griff schwarz
 Manche POM noir

Art-Nr./No d'article	Schnittlänge/tranchant	Preis/prix
8006.80726	8 cm	65.85



VICTORINOX
Santoku-Messer, geschmiedet
Couteau santoku, forgés
 POM-Griff schwarz
 Manche POM noir

Art-Nr./No d'article	Schnittlänge/tranchant	Preis/prix
8006.80727	17 cm	117.25



VICTORINOX
Santoku-Messer, geschmiedet
Couteau santoku, forgés
 POM-Griff schwarz, mit kullenschliff
 Manche POM noir, avec tranchant alvéolé

Art-Nr./No d'article	Schnittlänge/tranchant	Preis/prix
8006.80728	17 cm	143.50



VICTORINOX
Kochmesser, geschmiedet
Couteau de chef, forgés
 POM-Griff schwarz
 Manche POM noir

Art-Nr./No d'article	Schnittlänge/tranchant	Preis/prix
8006.80729	15 cm	102.10
8006.80730	20 cm	123.50
8006.80731	25 cm	143.50



VICTORINOX
Brotmesser, geschmiedet
Couteau à pain, forgés
 POM-Griff schwarz
 Manche POM noir

Art-Nr./No d'article	Schnittlänge/tranchant	Preis/prix
8006.80732	23 cm	123.50

MESSER, SCHNEIDGERÄTE / COUPELLERIE



VICTORINOX
Officemesser
Couteau d'office
 Fibrox-Griff schwarz
 Manche fibrox noir

Art-Nr./No d'article	Schnittlänge/tranchant	Preis/prix
8006.80189	12 cm	24.90
8006.80190	15 cm	25.85



VICTORINOX
Tranchiermesser
Couteau à découper
 Griff schwarz, breitere Klinge
 Manche noir, lame large

Art-Nr./No d'article	Schnittlänge/tranchant	Preis/prix
8006.80295	19 cm	34.05



VICTORINOX
Tranchiermesser
Couteau à découper
 Fibrox-Griff schwarz, schmale Klinge
 Manche fibrox noir, lame étroite

Art-Nr./No d'article	Schnittlänge/tranchant	Preis/prix
8006.80306	15 cm	22.30
8006.80307	18 cm	28.90



VICTORINOX
Küchen- und Officemesser
Couteau de cuisine et d'office
 Fibrox-Griff schwarz
 Manche fibrox noir

Art-Nr./No d'article	Schnittlänge/tranchant	Preis/prix
8006.80184	19 cm	34.05
8006.80185	22 cm	39.40
8006.80186	25 cm	49.35
8006.80188	31 cm	64.65



VICTORINOX
Tranchiermesser
Couteau à découper
 Griff schwarz, schmale Klinge
 Manche noir, lame étroite

Art-Nr./No d'article	Schnittlänge/tranchant	Preis/prix
8006.80298	12 cm	24.90
8006.80299	15 cm	25.40
8006.80300	18 cm	28.20



VICTORINOX
Filetmesser
Couteau à fileter
 Fibrox-Griff schwarz, flexible Klinge
 Manche fibrox noir, lame flexible

Art-Nr./No d'article	Schnittlänge/tranchant	Preis/prix
8006.80920	16 cm	26.10
8006.80921	18 cm	30.55
8006.80922	20 cm	32.30



VICTORINOX
Küchen- und Officemesser
Couteau de cuisine et d'office
 Fibrox-Griff schwarz, mit Wellenschliff
 Manche fibrox noir, avec tranchant denté

Art-Nr./No d'article	Schnittlänge/tranchant	Preis/prix
8006.80318	19 cm	35.15
8006.80319	22 cm	44.65
8006.80320	25 cm	57.60



VICTORINOX
Tranchiermesser
Couteau à découper
 Fibrox-Griff schwarz, mit extra breiter Klinge
 Manche fibrox noir, lame extra-large

Art-Nr./No d'article	Schnittlänge/tranchant	Preis/prix
8006.80194	20 cm	42.30



VICTORINOX
Filetmesser
Couteau à fileter
 Fibrox-Griff schwarz, flexible schmale Klinge
 Manche fibrox noir, lame flexible étroite

Art-Nr./No d'article	Schnittlänge/tranchant	Preis/prix
8006.80410	20 cm	31.70



**VICTORINOX
Fischfiletmesser
Couteau à fileter**

Fibrox-Griff schwarz, extra flexible Klinge
Manche fibrox noir, lame très flexible

Art-Nr./No d'article	Schnittlänge/tranchant	Preis/prix
8006.80205	18 cm	32.90



**VICTORINOX
Schlacht- und Bankmesser
Couteau de boucher**

Fibrox-Griff schwarz
Manche fibrox noir

Art-Nr./No d'article	Schnittlänge/tranchant	Preis/prix
8006.80900	16 cm	30.55
8006.80901	18 cm	34.05
8006.80902	20 cm	35.15
8006.80903	23 cm	38.20
8006.80904	26 cm	44.65
8006.80905	28 cm	56.40
8006.80906	31 cm	61.15



**VICTORINOX
Ausbeinmesser
Couteau à désosser**

Fibrox-Griff schwarz, gerade, breite Klinge
Manche fibrox noir, lame droite, large

Art-Nr./No d'article	Schnittlänge/tranchant	Preis/prix
8006.80394	12 cm	21.85
8006.80396	15 cm	23.40



**VICTORINOX
Ausbeinmesser
Couteau à désosser**

Fibrox-Griff schwarz, gerade, schmale Klinge
Manche fibrox noir, lame droite, étroite

Art-Nr./No d'article	Schnittlänge/tranchant	Preis/prix
8006.80397	12 cm	22.95
8006.80398	15 cm	23.50



**VICTORINOX
Ausbeinmesser
Couteau à désosser**

Fibrox-Griff schwarz, geschweifte, breitere Klinge
Manche fibrox noir, lame cambrée, large

Art-Nr./No d'article	Schnittlänge/tranchant	Preis/prix
8006.80349	12 cm	21.85
8006.80350	15 cm	23.50



**VICTORINOX
Ausbeinmesser
Couteau à désosser**

Fibrox-Griff schwarz, geschweifte, schmale Klinge
Manche fibrox noir, lame cambrée, étroite

Art-Nr./No d'article	Schnittlänge/tranchant	Preis/prix
8006.80353	12 cm	23.50
8006.80354	15 cm	25.40



**VICTORINOX
Ausbeinmesser
Couteau à désosser**

Fibrox-Griff schwarz, gebogene, breite Klinge
Manche fibrox noir, lame coudée, large

Art-Nr./No d'article	Schnittlänge/tranchant	Preis/prix
8006.80440	15 cm	22.95

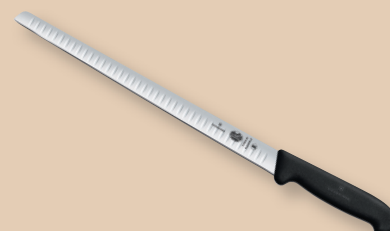

**VICTORINOX
Lachsmesser
Couteau à saumon**

Griff schwarz, flexibel mit Kullenschliff
Manche noir, flexible avec tranchant alvéolé

Art-Nr./No d'article	Schnittlänge/tranchant	Preis/prix
8006.80414	30 cm	56.40



**VICTORINOX
DUX-Tranchiermesser
Couteau à découper DUX**

Griff schwarz, mit Wellenschliff und verstellbarer Führung für Schnittbreiten von 1 bis 15 mm
Manche noir, denté avec dispositif réglable pour tranches de 1 à 15 mm

Art-Nr./No d'article	Schnittlänge/tranchant	Preis/prix
8006.80120	21 cm	93.75

MESSER, SCHNEIDGERÄTE / COUPELLERIE

**VICTORINOX
Schinkenmesser
Couteau à jambon**

Griff schwarz, rund, Klingebreite 30 mm
Manche noir, ronde, largeur de la lame 30 mm

Art-Nr./No d'article	Schnittlänge/tranchant	Preis/prix
8006.80153	25 cm	42.30
8006.80154	30 cm	46.90
8006.80155	36 cm	56.40

**VICTORINOX
Schinkenmesser
Couteau à jambon**

Griff schwarz, mit Wellenschliff
Manche noir, avec tranchant denté

Art-Nr./No d'article	Schnittlänge/tranchant	Preis/prix
8006.80561	25 cm	41.15
8006.80562	30 cm	46.90
8006.80563	36 cm	61.15

**VICTORINOX
Konditorsäge
Couteau denté pour pâtisiers**

Fibrox-Griff schwarz, mit Wellenschliff
Manche fibrox noir, avec tranchant denté

Art-Nr./No d'article	Schnittlänge/tranchant	Preis/prix
8006.80940	26 cm	42.30

**VICTORINOX
Brotmesser
Couteau à pain**

Griff schwarz, mit Wellenschliff
Manche noir, avec tranchant denté

Art-Nr./No d'article	Schnittlänge/tranchant	Preis/prix
8006.80085	21 cm	34.65

**VICTORINOX
Brotmesser
Couteau à pain**

Fibrox-Griff schwarz, mit Wellenschliff
Manche fibrox noir, avec tranchant denté

Art-Nr./No d'article	Schnittlänge/tranchant	Preis/prix
8006.80103	21 cm	32.30

**VICTORINOX
Butter- und Weichkäsemesser
Couteau à beurre et à fromage**

Griff schwarz, Kullenschliff
Manche noir, tranchant alvéolé

Art-Nr./No d'article	Schnittlänge/tranchant	Preis/prix
8006.80505	21 cm	72.65

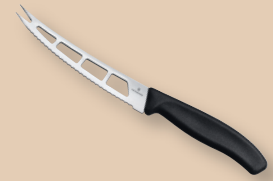
**VICTORINOX
Butter- und Weichkäsemesser
Couteau à beurre et à fromage**

Griff schwarz, mit gelochter Klinge, gezahnter Schliff, Solinger-Fabr.
Manche noir, avec lame perforée, tranchant denté, fabr. à Solingen

Art-Nr./No d'article	Schnittlänge/tranchant	Preis/prix
8006.80506	13 cm	22.30

**VICTORINOX
Käseschaufel
Couteau à fromage**

Mit Nylongriff schwarz
Manche nylon noir

Art-Nr./No d'article	Größe/grandeur	Preis/prix
8006.80552	9 x 18 cm	69.35
8006.80553	16 x 18 cm	89.35

**VICTORINOX
Käsemesser
Couteau à fromage**

Mit 2 Nylongriffen schwarz
Avec 2 poignées nylon noir

Art-Nr./No d'article	Schnittlänge/tranchant	Preis/prix
8006.80550	30 cm	109.85
8006.80551	36 cm	129.35



VICTORINOX
Fleisch- und Bratengabel
Fourchette à viande et rôti

Griff schwarz, flach
Manche noir, dents plates

Art-Nr./No d'article Länge/longueur Preis/prix
8006.80570 15 cm **24.90**

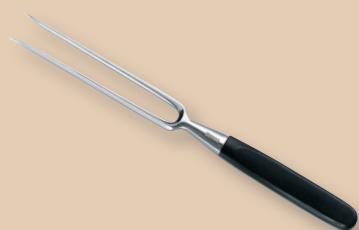

VICTORINOX
Tranchiergabel
Fourchette à viande

Griff schwarz, gerade, geschmiedet
Manche noir, droite, forgée

Art-Nr./No d'article Länge/longueur Preis/prix
8006.80564 18 cm **61.15**



VICTORINOX
Fleischklopfer
Battoir à viande

Inox 18/10
Inox 18/10

Art-Nr./No d'article Grösse/grandeur Preis/prix
8006.80246 12 x 12 cm x H 28 cm **114.65**



VICTORINOX
Magnetschiene «Major»
Barre magnétique «Major»

35 cm lang, 3 Loch
longueur 35 cm, 3 trous

Art-Nr./No d'article Preis/prix
8006.80393 **31.70**



VICTORINOX
Küchenstahl
Fusil de cuisine

Rund, Kunststoffgriff schwarz, Mittelfeinzug
Ronde, manche plastique noir, taille mi-fine

Art-Nr./No d'article Länge/longueur Preis/prix
8006.80367 27 cm **28.20**



VICTORINOX
Metzgerstahl
Fusil de boucher

Oval, Kunststoffgriff rot, Mikrofeinzug, ultrahart verchromt
Oval, manche plastique rouge, taille micro-fine, chromé ultradur

Art-Nr./No d'article Länge/longueur Preis/prix
8006.80368 30 cm **69.35**



Desinfektionsschrank für Kochmesser
Armoire de décontamination

Mit Korb aus rostfreiem Stahldraht für 20 Messer, ohne Schloss, Gewicht 9,5 kg, Anschluss 230 V/0,18 kW

Avec panier fil por 20 couteaux, sans verroure, poids 9,5 kg, puissance 230 V / 0,18 kW

Art-Nr./No d'article Grösse/grandeur Preis/prix
8006.97027 58,7 x 13,6 x H 73,8 cm **764.65**



Messerrolltasche
Trousse enroulable pour couteaux

aus schwarzem Kunstleder auf Gewebebasis mit rotem Rand und zwei Druckknöpfen, für Messer bis max. 40 cm Länge, zum Selbstbestücken
en simili cuir noir, sur une base de tissu avec bordure rouge et deux boutons-pression, pour couteaux d'une longueur max. de 40 cm, sans contenu

Art-Nr./No d'article	Grösse/grandeur	Teile/parti	Preis/prix
8006.42355	43 x 42 cm	6	32.30
8006.42356	50 x 47 cm	9	36.95



Messerhalteplatte
Porte-couteaux pour tiroir

Passend in Gastro Norm Schubladen. Aus geschliffenem Polyethylen mit hochwertig verarbeiteten Laschen. Zur praktischen Aufnahme und Lagerung von 12 verschiedenen Messern.
Va dans les tiroirs de dimension Gastro Norm. En Polyéthylène poli avec des pattes confectionnées de haute qualité. Pour recevoir d'une manière pratique 12 couteaux différents.

Art-Nr./No d'article Grösse/grandeur Preis/prix
8006.80600 50 x 30 cm **198.95**



VICTORINOX
Schutzhandschuhe
Gants de protection

Gute Schneidresistenz, universell einsetzbar, aus Brinix® (0,05 mm), A8C, Polyester, rostfreier Stahl
Gant avec gaine extérieur en polyester spécial, pour obtenir un meilleur «toucher».

Art-Nr./No d'article	Grösse/grandeur	Preis/prix
8006.80431	klein/petit	19.15
8006.80432	mittel/moyenne	19.15
8006.80433	gross/grande	19.15

MESSER, SCHNEIDGERÄTE / COUPELLERIE

**VICTORINOX
Messermappe-Set
Set de couteaux**

Messermappe schwarz, Meshfächer zur Aufbewahrung kleiner Utensilien
Porte-couteaux noire, compartiments en maille pour le rangement de petits ustensiles

Art-Nr./No d'article Masse/dimension
8006.80830 21 x 8 x 47 cm

Preis/prix
647.00



Enthaltend:
 Santoku, 17 cm, Fibrox
 Tranchiergabel, geschmiedet
 Austernöffner
 Swiss Classic Gemüsemesser, 10cm
 Swiss Classic Tranchiermesser
 Schlacht- und Bankmesser
 Transchiermesser
 Konidtorsäge, Wellenschliff
 Ausbeinmesser
 Metzgerstahl, 30cm, rund
 Fischechere, rostfrei
 Spachtel, flexibel

Comprenant:
 Santoku, 17 cm, Fibrox
 Fourchette à découper, forgée
 Ouvreur d'huîtres
 Swiss Classic couteau à légumes, 10cm
 Couteau à trancher Swiss Classic
 Couteaux de boucherie et d'égal
 Couteau à trancher
 Scie à découper, à lame crantée
 Couteau à désosser
 Acier de boucherie, 30cm, rond
 Ciseaux à poisson, inox
 Spatule, flexible

**VICTORINOX
Kochrucksack und Messermappe im Set
Sac à dos de cuisine et porte-couteaux en kit**

Rucksack schwarz, mit Fach für 17-Zoll-Laptop, herausnehmbarer Trenneinsatz
 Messermappe schwarz, Meshfächer zur Aufbewahrung kleiner Utensilien
 Sac à dos noir, avec compartiment pour ordinateur portable 17 pouces, insert de séparation amovible, Porte-couteaux noire, compartiments en maille pour le rangement de petits ustensiles

Art-Nr./No d'article Masse/dimension
8006.80840 33 x 14 x 50 cm / 21 x 8 x 47 cm

Preis/prix
764.00



Enthaltend:
 Santoku 17 cm Fibrox
 Tranchiergabel geschmiedet
 Austernöffner
 Swiss Classic Gemüsemesser 10cm
 Swiss Classic Tranchiermesser
 Schlacht- und Bankmesser
 Transchiermesser
 Konidtorsäge mit Wellenschliff
 Ausbeinmesser
 Metzgerstahl 30 cm rund
 Fischechere rostfrei
 Spachtel flexibel

Comprenant:
 Santoku 17 cm Fibrox
 Fourchette à découper forgée
 Ouvreur d'huîtres
 Swiss Classic couteau à légumes 10cm
 Couteau à trancher Swiss Classic
 Couteaux de boucherie et d'égal
 Couteau à trancher
 Scie à découper à lame crantée
 Couteau à désosser
 Acier de boucherie 30 cm rond
 Ciseaux à poisson inox
 Spatule flexible



VICTORINOX
Kochrucksack
Sac à dos de cuisine

Rucksack schwarz, mit Fach für 17-Zoll-Laptop, herausnehmbarer Trenneinsatz
 Sac à dos noir, avec compartiment pour ordinateur portable 17 pouces, insert de séparation amovible

Art-Nr./No d'article Masse/dimension
8006.80810 33 x 14 x 50 cm

Preis/prix
129.35



VICTORINOX
Messermappe
Porte-couteaux de chef

Messermappe schwarz, 21 x 8 x 47 cm, Meshfächer zur Aufbewahrung kleiner Utensilien
 Porte-couteaux noire, 21 x 8 x 47 cm, compartiments en maille pour le rangement de petits ustensiles

Art-Nr./No d'article Masse/dimension
8006.80820 21 x 8 x 47 cm

Preis/prix
117.25



MESSER, SCHNEIDGERÄTE / COUPELLERIE



«Kai Shun Premier»
Allzweckmesser
Couteau universel

Art-Nr./No d'article	Schnittlänge/tranchant	Preis/prix
8006.42525	16,5 cm	TDM-1701 218.80



«Kai Shun Premier»
Santoku-Messer
Couteau santoku

Art-Nr./No d'article	Schnittlänge/tranchant	Preis/prix
8006.42526	18 cm	TDM-1702 312.90



«Kai Shun Premier»
Schinkenmesser
Couteau à jambon

Art-Nr./No d'article	Schnittlänge/tranchant	Preis/prix
8006.42527	24 cm	TDM-1704 312.90



«Kai Shun»
Santoku mit Kullenschliff
Santoku à lame alvéolée

Art-Nr./No d'article	Schnittlänge/tranchant	Preis/prix
8006.42535	16,5 cm	AB-5157 107.60



«Kai Shun»
Kochmesser
Couteau de cuisine

Art-Nr./No d'article	Schnittlänge/tranchant	Preis/prix
8006.42537	24 cm	AB-5160 107.60



«Kai Shun»
Kochmesser
Couteau de cuisine

Art-Nr./No d'article	Schnittlänge/tranchant	Preis/prix
8006.42536	21 cm	AB-5159 93.75



«Kai Shun»
Allzweckmesser
Couteau universel

Art-Nr./No d'article	Schnittlänge/tranchant	Preis/prix
8006.42538	15 cm	AB-5161 77.40



«Kai Shun Premier»
Brotmesser
Couteau à pain
spezieller Wellenschliff
tranchant ondulé

Art-Nr./No d'article	Schnittlänge/tranchant	Preis/prix
8006.42528	23 cm	TDM-1705 329.35



**«Kai Shun»
Officemesser
Couteau d'office**

Art.-Nr./No d'article Schnittlänge/tranchant Preis/prix
8006.42501 9 cm DM-0700 157.60



**«Kai Shun»
Allzweckmesser
Couteau universel**

Art.-Nr./No d'article Schnittlänge/tranchant Preis/prix
8006.42502 15 cm DM-0701 183.50



**«Kai Shun»
Brotmesser
Couteau à pain**
spezieller Wellenschliff
tranchant ondulé

Art.-Nr./No d'article Schnittlänge/tranchant Preis/prix
8006.42505 22,5 cm DM-0705 312.90

**«Kai Shun»
Santoku-Messer
Couteau santoku**

Art.-Nr./No d'article Schnittlänge/tranchant Preis/prix
8006.42503 18 cm DM-0702 294.05



**«Kai Shun»
Schinkenmesser
Couteau à jambon**

Art.-Nr./No d'article Schnittlänge/tranchant Preis/prix
8006.42504 22,5 cm DM-0704 294.05



**«Kai Shun»
Kochmesser
Couteau de cuisine**

Art.-Nr./No d'article Schnittlänge/tranchant Preis/prix
8006.42507 25 cm DM-0707 336.40



**«Kai Shun»
Kochmesser
Couteau de cuisine**

Art.-Nr./No d'article Schnittlänge/tranchant Preis/prix
8006.42506 20 cm DM-0706 298.85



**«Kai Shun»
Steakmesser
Couteau à steak**

Art.-Nr./No d'article Schnittlänge/tranchant Preis/prix
8006.42508 12,5 cm DM-0711 171.70



**«Kai Shun»
Grosses Santoku
Grand santoku**

Art.-Nr./No d'article Schnittlänge/tranchant Preis/prix
8006.42509 19 cm DM-0717 351.70

MESSER, SCHNEIDGERÄTE / COUPELLERIE



**«Kai Shun»
Nakiri
Nakiri**

Art-Nr./No d'article	Schnittlänge/tranchant	Preis/prix
8006.42510	16,5 cm	DM-0728 312.90



**«Kai Shun»
Filiermesser flexibel
Couteau à filet flexible**

Art-Nr./No d'article	Schnittlänge/tranchant	Preis/prix
8006.42511	18 cm	DM-0761 218.80

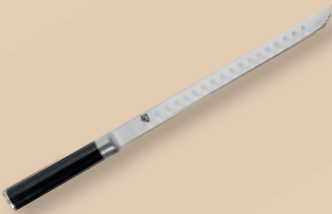

**«Kai Shun»
Lachs/Schinkenmesser flexibel
Couteau à saumon/jambon flexible**
mit Wellenschliff
à lame alvéolée

Art-Nr./No d'article	Schnittlänge/tranchant	Preis/prix
8006.42512	25,4 cm	DM-0765 234.05



**«Kai Shun»
Ausbeinmesser
Couteau à désosser**

Art-Nr./No d'article	Schnittlänge/tranchant	Preis/prix
8006.42513	15 cm	DM-0710 223.45



**«Kai Shun»
Tourniermesser
Couteau à éplucher**

Art-Nr./No d'article	Schnittlänge/tranchant	Preis/prix
8006.42514	6,5 cm	DM-0715 157.60



**«Kai Shun»
Kombi-Wetzstein
Combinaison d'ayusage**

Art-Nr./No d'article	Grösse/grandeur	Preis/prix
Körnung: 300/1000		
8006.42520	18,4 x 6,2 x H 2,8 cm	107.60
Körnung: 1000/6000		
8006.42519	18,4 x 6,2 x H 2,8 cm	195.25



**«Kai Shun»
Elektrischer Messerschärfer + Poliereinheit
Aiyuseur élec. + Mout.**

für Damast und Stahlmesser
Der Messerschärfer von Kai schleift mit 2 keramischen Schleifsteinen jedes Stahlmesser scharf. Mit schlichtem Design überzeugt der Messerschärfer überall.

Technische Daten:
Stromversorgung: 230 V / 50 Hz
Stromverbrauch: 60 Watt
Kurzzeitbetrieb: 2 Minuten
Abmessungen: 138 x 111 x 105
Gewicht: 875 g
Schleifstein: Alundun
Inklusive austauschbarer Poliereinheit

de rechange et molettes
L'aiguiseur de Kai affûte à l'aide de 2 meules en céramique chaque couteau. Cet aiguiseur convainc par son design simple.

Données techniques:
Alimentation électrique: 230 V / 50 Hz
Cons. d'énergie: 60 Watt
Durée d'emploi: 2 minutes
Dimensions: 138 x 111 x 105
Poids: 875 g
Molettes: Alundun, Avec unité de polissage

Art-Nr./No d'article	Grösse/grandeur	Preis/prix
8006.42518	13,8 x 11,1 x H 10 cm	163.50









GASTRONORM / GASTRONORME

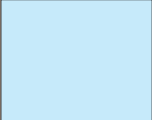
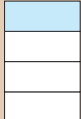

Gastronorm-Grössenschema Schema des dimensions Gastronorme

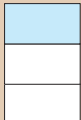
Alle Gastronormbehälter entsprechen der europäischen Norm EN 631
Tous les articles gastronormes conforment aux normes européennes EN-631

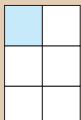
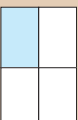
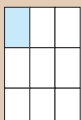
	GN 2/1 650 x 530 mm		GN 2/8 325 x 132 mm
	GN 1/1 325 x 530 mm		GN 2/3 325 x 354 mm
	GN 1/2 325 x 265 mm		GN 1/3 325 x 176 mm
	GN 2/4 162 x 530 mm		GN 1/6 162 x 176 mm
	GN 1/4 162 x 265 mm		GN 1/9 108 x 176 mm

Deckelvarianten Variantes de couvercles



Deckel mit Griffmulde
Couvercle avec moulure centrale



Deckel mit Griffaussparung
Couvercle avec découpes pour poignées escamotables



Steckdeckel
Couvercle encastrable



Deckel mit Dichtung
Couvercle étanche



Deckel mit Löffelausschnitt
Couvercle avec découpes poignées et louche



Universal-Scharnierdeckel
Couvercle à charnières

HUPFER

HUPFER Gastronormbehälter Bac gastronorme

GN-Schalen, Bleche, Roste vom Edelstahlspezialisten für Verpflegung und Grossküchentechnik

Bacs gastronomiques, tôles, grilles du spécialiste d'inox pour distribution de repas et technique de grand cuisine



HUPFER GN 2/1, 650 x 530 mm

Ohne Griffe
Sans poignées

Art-Nr./No d'article	Tiefe/profondeur	Inhalt/capacité	Preis/prix
01.3050.2 H	20 mm	–	68.20
01.3051.2 H	40 mm	10,0 l	82.10
01.3052.2 H	65 mm	17,0 l	86.90
01.3053.2 H	100 mm	27,0 l	107.60
01.3054.2 H	150 mm	41,0 l	163.50
01.3055.2 H	200 mm	55,0 l	206.95



HUPFER GN 1/1, 530 x 325 mm

Ohne Griffe
Sans poignées

Art-Nr./No d'article	Tiefe/profondeur	Inhalt/capacité	Preis/prix
01.3060.2 H	20 mm	–	33.50
01.3061.2 H	40 mm	3,4 l	41.15
01.3062.2 H	65 mm	7,0 l	44.65
01.3063.2 H	100 mm	11,7 l	56.40
01.3064.2 H	150 mm	18,4 l	69.95
01.3065.2 H	200 mm	26,0 l	107.60

01.3164.2 H Deckel mit Griffmulde **44.65**

*Couvercle avec moulure
centrale et poignées*

01.3225.2 HD Deckel mit Dichtung **152.90**

Couvercle étanche



HUPFER GN 2/3, 325 x 352 mm

Ohne Griffe
Sans poignées

Art-Nr./No d'article	Tiefe/profondeur	Inhalt/capacité	Preis/prix
01.3120.2 H	20 mm	–	29.35
01.3121.2 H	40 mm	2,4 l	33.50
01.3122.2 H	65 mm	4,3 l	36.95
01.3123.2 H	100 mm	7,4 l	51.70
01.3124.2 H	150 mm	11,8 l	68.20
01.3125.2 H	200 mm	15,3 l	93.75

01.3169.2 H Deckel mit Griffmulde **30.55**

*Couvercle avec moulure
centrale et poignées*

01.3227.2 HD Deckel mit Dichtung **104.20**

Couvercle étanche



HUPFER
GN 1/2, 325 x 265 mm
Ohne Griffe
Sans poignées

Art-Nr./No d'article	Tiefe/profondeur	Inhalt/capacité	Preis/prix
01.3075.2 H	20 mm	–	21.85
01.3076.2 H	40 mm	1,7 l	28.20
01.3077.2 H	65 mm	3,3 l	32.30
01.3078.2 H	100 mm	5,3 l	36.95
01.3079.2 H	150 mm	8,4 l	56.40
01.3080.2 H	200 mm	10,9 l	68.20

01.3165.2 H	Deckel mit Griffmulde Couvercle avec moulure centrale et poignées	27.75
01.3229.2 HD	Deckel mit Dichtung Couvercle étanche	99.75

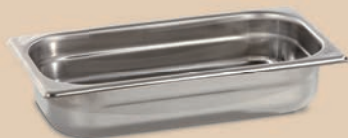

HUPFER
GN 1/3, 325 x 176 mm
Ohne Griffe
Sans poignées

Art-Nr./No d'article	Tiefe/profondeur	Inhalt/capacité	Preis/prix
01.3135.2 H	20 mm	–	21.15
01.3136.2 H	40 mm	1,0 l	23.50
01.3137.2 H	65 mm	2,0 l	28.20
01.3138.2 H	100 mm	3,3 l	34.65
01.3139.2 H	150 mm	4,9 l	49.35
01.3140.2 H	200 mm	6,6 l	62.30

01.3170.2 H	Deckel mit Griffmulde Couvercle avec moulure centrale et poignées	21.15
01.3231.2 HD	Deckel mit Dichtung Couvercle étanche	84.55



HUPFER
GN 1/4, 265 x 162 mm
Ohne Griffe
Sans poignées

Art-Nr./No d'article	Tiefe/profondeur	Inhalt/capacité	Preis/prix
01.3330.2 H	40 mm	–	23.50
01.3102.2 H	65 mm	1,5 l	27.75
01.3103.2 H	100 mm	2,3 l	31.70
01.3104.2 H	150 mm	3,6 l	40.65
01.3105.2 H	200 mm	5,0 l	55.25

01.3167.2 H	Deckel mit Griffmulde Couvercle avec moulure centrale et poignées	17.95
01.3233.2 HD	Deckel mit Dichtung Couvercle étanche	65.85

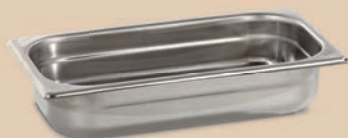

HUPFER
GN 2/8, 325 x 132 mm
Ohne Griffe
Sans poignées

Art-Nr./No d'article	Tiefe/profondeur	Inhalt/capacité	Preis/prix
01.3310.2 H	100 mm	2,6 l	36.95
01.3311.2 H	150 mm	3,9 l	46.90

01.3312.2 H	Deckel mit Griffmulde Couvercle avec moulure centrale et poignées	16.40
--------------------	---	--------------

GASTRONORM / GASTRONORME

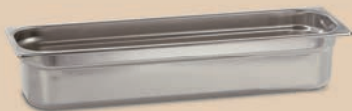

HUPFER
GN 2/4, 162 x 530 mm
 Ohne Griffe
 Sans poignées

Art-Nr./No d'article	Tiefe/profondeur	Inhalt/capacité	Preis/prix
01.3090.2 H	20 mm	–	32.30
01.3091.2 H	40 mm	1,7 l	39.95
01.3092.2 H	65 mm	3,3 l	43.50
01.3093.2 H	100 mm	5,3 l	64.65
01.3094.2 H	150 mm	8,4 l	81.15

01.3184.2 H Deckel mit Griffmulde
 Couverture avec moulure
 centrale et poignées **30.55**



HUPFER
GN 1/6, 162 x 176 mm
 Ohne Griffe
 Sans poignées

Art-Nr./No d'article	Tiefe/profondeur	Inhalt/capacité	Preis/prix
01.3150.2 H	65 mm	0,9 l	21.15
01.3151.2 H	100 mm	1,4 l	25.40
01.3152.2 H	150 mm	2,1 l	41.15
01.3153.2 H	200 mm	2,8 l	68.20

01.3171.2 H Deckel mit Griffmulde
 Couverture avec moulure
 centrale et poignées **14.80**

01.3235.2 HD Deckel mit Dichtung
 Couverture étanche **58.80**



HUPFER
GN 1/9, 176 x 108 mm
 Ohne Griffe
 Sans poignées

Art-Nr./No d'article	Tiefe/profondeur	Inhalt/capacité	Preis/prix
01.3162.2 H	65 mm	0,5 l	21.15
01.3163.2 H	100 mm	0,7 l	28.20

01.3172.2 H Deckel mit Griffmulde
 Couverture avec moulure
 centrale et poignées **11.70**

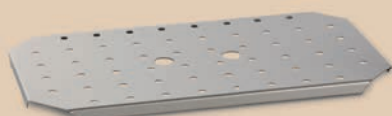

HUPFER
Einlegeboden gelocht
Fond perforé

Art-Nr./No d'article	Grösse/grandeur	Preis/prix
01.3252.2 HBGN 1/1		52.90
01.3253.2 HBGN 1/2		34.65



HUPFER
GN-Behälter zum Einsetzen
Bacs Gastronomique à emboîter
 Inox 18/10 gelocht, ohne Griffe
 Inox 18/10 perforé, sans poignées

GN 2/1, 650 x 530 mm

Art-Nr./No d'article	Tiefe/profondeur	Preis/prix
01.3331.2 H	65 mm	163.50
01.3313.2 H	100 mm	206.95
01.3314.2 H	150 mm	282.30

GN 1/1, 530 x 325 mm

Art-Nr./No d'article	Tiefe/profondeur	Preis/prix
01.3298.2 H	40 mm	55.25
01.3316.2 H	65 mm	86.90
01.3317.2 H	100 mm	107.60
01.3318.2 H	150 mm	152.90
01.3319.2 H	200 mm	178.80

GN 2/3, 325 x 352 mm

Art-Nr./No d'article	Tiefe/profondeur	Preis/prix
01.3306.2 H	20 mm	46.90
01.3320.2 H	65 mm	56.40
01.3321.2 H	100 mm	68.20
01.3322.2 H	150 mm	104.20
01.3323.2 H	200 mm	136.50

GN 1/2, 325 x 265 mm

Art-Nr./No d'article	Tiefe/profondeur	Preis/prix
01.3305.2 H	40 mm	32.30
01.3324.2 H	65 mm	38.20
01.3325.2 H	100 mm	55.25
01.3326.2 H	150 mm	81.15
01.3327.2 H	200 mm	89.75

GN 1/3, 325 x 176 mm

Art-Nr./No d'article	Tiefe/profondeur	Preis/prix
01.3328.2 H	40 mm	27.75
01.3329.2 H	65 mm	30.55
01.3307.2 H	100 mm	42.30
01.3303.2 H	150 mm	61.15
01.3304.2 H	200 mm	81.15



HUPFER
Stege für Behälter-Zusammenstellung
Barettes de composition

Art-Nr./No d'article	Grösse/grandeur	Preis/prix
01.3251.2 H	GN 1/1 - 530 mm	10.55
01.3252.2 H	GN 1/2 - 325 mm	7.25

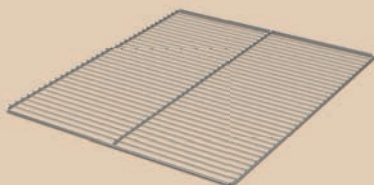

Gastronormroste
Grilles Gastronomique

Inox 18/10
 Inox 18/10

Art-Nr./No d'article	Grösse/grandeur	Preis/prix
01139029	GN 1/1	41.15
01139129	GN 2/1	86.90

Rieber

RIEBER
Gastronormbehälter
Bac gastronorme



RIEBER
GN 2/1, 650 x 530 mm

Ohne Griffe
Sans poignées

Art-Nr./No d'article	Tiefe/profondeur	Inhalt/capacité	Preis/prix
8122.20000	20 mm	–	102.10
8122.20001	40 mm	10,0 l	123.50
8122.20002	65 mm	17,0 l	138.60
8122.20003	100 mm	27,0 l	166.90
8122.20004	150 mm	41,0 l	249.35
8122.20005	200 mm	55,0 l	319.35



RIEBER
GN 1/1, 530 x 325 mm

Ohne Griffe
Sans poignées

Art-Nr./No d'article	Tiefe/profondeur	Inhalt/capacité	Preis/prix
8122.20010	20 mm	–	44.65
8122.20011	40 mm	3,4 l	58.55
8122.20013	65 mm	7,0 l	61.15
8122.20014	100 mm	11,7 l	73.85
8122.20015	150 mm	18,4 l	117.25
8122.20016	200 mm	26,0 l	138.60

8122.20110 Deckel mit Griffmulde **56.40**

Couvercle avec moule
centrale et poignées

8122.20111 Deckel mit Löffelausschnitt **66.95**

Couvercle avec découpes
pour louche

8122.20112 Steckdeckel **76.20**

Couvercle emboîtable

8122.20113 Deckel mit Dichtung **211.55**

Couvercle étanche

8122.20114 Universal-Scharnierdeckel **161.15**

Couvercle à charnières

8122.20115 Universal-Scharnierdeckel **163.50**

mit Löffelaussparung

Couvercle à charnières

avec découpes pour louche



RIEBER
GN 1/1, 530 x 325 mm

Mit versenkbaren Griffen
Avec poignées escamotables

Art-Nr./No d'article	Tiefe/profondeur	Inhalt/capacité	Preis/prix
8122.21010	55 mm	5,6 l	88.20
8122.21011	65 mm	7,0 l	93.75
8122.21012	100 mm	11,7 l	111.25
8122.21013	150 mm	18,4 l	143.50
8122.21014	200 mm	26,0 l	181.15

8122.21110 Deckel mit Griffaussparung **63.50**

Couvercle avec découpes
pour poignées escamotables

8122.21111 Deckel mit Griff- **73.85**

u. Löffelaussparung
Couvercle avec découpes
pour poignées et louche

8122.21112 Steckdeckel **85.75**

mit Griffaussparung

Couvercle encastrable

avec découpes pour poignées

8122.21113 Scharnierdeckel **171.70**

mit Griffaussparung

Couvercle à charnières

avec découpes pour poignées

8122.21114 Scharnierdeckel mit Löffel- **188.20**

u. Griffaussparung

Couvercle à charnières avec

découpes pour louche et poignées



RIEBER
GN 2/3, 325 x 352 mm
Ohne Griffe
Sans poignées

Art-Nr./No d'article	Tiefe/profondeur	Inhalt/capacité	Preis/prix
8122.20020	20 mm	–	43.50
8122.20021	40 mm	2,4 l	51.70
8122.20022	65 mm	4,3 l	63.50
8122.20023	100 mm	7,4 l	73.85
8122.20024	150 mm	11,8 l	102.10
8122.20025	200 mm	15,3 l	152.90

- 8122.20120** Deckel mit Griffmulde **46.90**
Couvercle avec moulure centrale et poignées
- 8122.20121** Deckel mit Löffelausschnitt **56.40**
Couvercle avec découpes pour louche
- 8122.20122** Steckdeckel **69.35**
Couvercle encastrable
- 8122.20123** Deckel mit Dichtung **188.20**
Couvercle étanche



RIEBER
GN 2/3, 325 x 352 mm
Mit versenkbaren Griffen
Avec poignées escamotables

Art-Nr./No d'article	Tiefe/profondeur	Inhalt/capacité	Preis/prix
8122.21020	65 mm	4,3 l	91.60
8122.21021	100 mm	7,4 l	107.60
8122.21022	150 mm	11,8 l	138.60
8122.21023	200 mm	15,3 l	181.15

- 8122.21120** Deckel mit Griffaussparung **54.05**
Couvercle avec découpes pour poignées escamotables
- 8122.21121** Deckel mit Griff- **66.95**
u. Löffelaussparung
Couvercle avec découpes poignées et louche
- 8122.21122** Steckdeckel **93.75**
mit Griffaussparung
Couvercle encastrable avec découpes pour poignées



RIEBER
GN 1/2, 325 x 265 mm
Ohne Griffe
Sans poignées

Art-Nr./No d'article	Tiefe/profondeur	Inhalt/capacité	Preis/prix
8122.20030	20 mm	–	32.90
8122.20031	40 mm	1,7 l	44.65
8122.20032	55 mm	2,6 l	46.90
8122.20033	65 mm	3,3 l	44.65
8122.20034	100 mm	5,3 l	50.55
8122.20035	150 mm	8,4 l	79.85
8122.20036	200 mm	10,9 l	91.60

- 8122.20130** Deckel mit Griffmulde **35.15**
Couvercle avec moulure centrale et poignées
- 8122.20131** Deckel mit Löffelausschnitt **46.90**
Couvercle avec découpes pour louche
- 8122.20132** Deckel mit Dichtung **138.60**
Couvercle étanche
- 8122.20133** Scharnierdeckel **129.35**
Couvercle à charnières
- 8122.20134** Steckdeckel **52.90**
Couvercle encastrable



RIEBER
GN 1/2, 325 x 265 mm
Mit versenkbaren Griffen
Avec poignées escamotables

Art-Nr./No d'article	Tiefe/profondeur	Inhalt/capacité	Preis/prix
8122.21030	55 mm	2,6 l	76.20
8122.21031	65 mm	3,3 l	64.65
8122.21032	100 mm	5,3 l	73.85
8122.21033	150 mm	8,4 l	102.10
8122.21034	200 mm	10,9 l	111.25

- 8122.21130** Deckel mit Griffaussparung **49.35**
Couvercle avec découpes pour poignées escamotables
- 8122.21131** Deckel mit Griff- **54.05**
u. Löffelaussparung
Couvercle avec découpes poignées et louche
- 8122.21132** Steckdeckel mit **61.15**
Griffaussparung
Couvercle encastrable avec découpes pour poignées

GASTRONORM / GASTRONORME



RIEBER
GN 1/3, 325 x 176 mm
Ohne Griffe
Sans poignées

Art-Nr./No d'article	Tiefe/profondeur	Inhalt/capacité	Preis/prix
8122.20040	20 mm	–	33.50
8122.20041	40 mm	1,0 l	40.65
8122.20042	65 mm	2,0 l	39.40
8122.20043	100 mm	3,3 l	49.35
8122.20044	150 mm	4,9 l	73.85
8122.20045	200 mm	6,6 l	91.60

8122.20140	Deckel mit Griffmulde Couvercle avec moulure centrale et poignées	31.70
8122.20141	Deckel mit Löffelausschnitt Couvercle avec découpes pour louche	40.65
8122.20142	Deckel mit Dichtung Couvercle étanche	123.50
8122.20143	Steckdeckel Couvercle encastrable	44.65



RIEBER
GN 1/3, 325 x 176 mm
Mit versenkbaren Griffen
Avec poignées escamotables

Art-Nr./No d'article	Tiefe/profondeur	Inhalt/capacité	Preis/prix
8122.21040	65 mm	2,0 l	72.65
8122.21041	100 mm	3,3 l	82.10
8122.21042	150 mm	4,9 l	102.10
8122.21043	200 mm	6,6 l	111.25

8122.21140	Deckel mit Griffaussparung Couvercle avec découpes pour poignées escamotables	40.65
8122.21141	Deckel mit Griff- u. Löffelaussparung Couvercle avec découpes poignées et louche	46.90
8122.21142	Steckdeckel mit Griffaussparung Couvercle encastrable avec découpes pour poignées	54.05



RIEBER
GN 1/4, 265 x 162 mm
Ohne Griffe
Sans poignées

Art-Nr./No d'article	Tiefe/profondeur	Inhalt/capacité	Preis/prix
8122.20050	20 mm	–	30.55
8122.20051	65 mm	1,5 l	46.90
8122.20052	100 mm	2,3 l	50.55
8122.20053	150 mm	3,6 l	70.55
8122.20054	200 mm	5,0 l	91.60

8122.20150	Deckel mit Griffmulde Couvercle avec moulure centrale et poignées	27.75
8122.20151	Deckel mit Löffelausschnitt Couvercle avec découpes pour louche	35.15
8122.20152	Deckel mit Dichtung Couvercle étanche	117.25
8122.20153	Steckdeckel Couvercle encastrable	40.65



RIEBER
GN 1/4, 265 x 162 mm
Mit versenkbaren Griffen
Avec poignées escamotables

Art-Nr./No d'article	Tiefe/profondeur	Inhalt/capacité	Preis/prix
8122.21050	65 mm	1,5 l	64.65
8122.21051	100 mm	2,3 l	82.10
8122.21052	150 mm	3,6 l	102.10
8122.21053	200 mm	5,0 l	117.25

8122.21150	Deckel mit Griffaussparung Couvercle avec découpes pour poignées escamotables	38.20
8122.21151	Deckel mit Griff- u. Löffelaussparung Couvercle avec découpes poignées et louche	46.90



RIEBER
GN 2/8, 325 x 132 mm
Ohne Griffe
Sans poignées

Art-Nr./No d'article	Tiefe/profondeur	Inhalt/capacité	Preis/prix
8122.20060	20 mm	–	49.35
8122.20061	65 mm	1,3 l	54.05
8122.20062	100 mm	2,6 l	70.55
8122.20063	150 mm	3,9 l	105.70
8122.20064	200 mm	5,6 l	138.60

8122.20160	Deckel mit Griffmulde Couvercle avec moulure centrale et poignées	40.65
8122.20161	Deckel mit Löffelausschnitt Couvercle avec découpes pour louche	49.35
8122.20162	Deckel mit Dichtung Couvercle étanche	99.75
8122.20163	Steckdeckel Couvercle encastrable	42.30



RIEBER
GN 2/8, 325 x 132 mm
Mit versenkbaren Griffen
Avec poignées escamotables

Art-Nr./No d'article	Tiefe/profondeur	Inhalt/capacité	Preis/prix
8122.21060	65 mm	1,3 l	79.85
8122.21061	100 mm	2,6 l	91.60
8122.21062	150 mm	3,9 l	130.55
8122.21063	200 mm	5,6 l	171.70

8122.21160	Deckel mit Griffaussparung Couvercle avec découpes pour poignées escamotables	50.55
8122.21161	Deckel mit Griff- u. Löffelaussparung Couvercle avec découpes poignées et louche	61.15



RIEBER
GN 2/4, 162 x 530 mm
Ohne Griffe
Sans poignées

Art-Nr./No d'article	Tiefe/profondeur	Inhalt/capacité	Preis/prix
8122.20070	20 mm	–	54.05
8122.20071	40 mm	1,7 l	77.60
8122.20072	65 mm	3,3 l	82.10
8122.20073	100 mm	5,3 l	117.25
8122.20074	150 mm	8,4 l	157.60

8122.20170	Deckel mit Griffmulde Couvercle avec moulure centrale et poignées	45.85
8122.20171	Deckel mit Löffelausschnitt Couvercle avec découpes pour louche	54.05



RIEBER
GN 2/4, 162 x 530 mm
Mit versenkbaren Griffen
Avec poignées escamotables

Art-Nr./No d'article	Tiefe/profondeur	Inhalt/capacité	Preis/prix
8122.21070	40 mm	1,7 l	111.25
8122.21071	65 mm	3,3 l	117.25
8122.21072	100 mm	5,3 l	132.90
8122.21073	150 mm	8,4 l	195.25

8122.21170	Deckel mit Griffaussparung Couvercle avec découpes pour poignées escamotables	54.05
8122.21171	Deckel mit Griff- u. Löffelaussparung Couvercle avec découpes poignées et louche	66.95

GASTRONORM / GASTRONORME



RIEBER
GN 1/6, 162 x 176 mm
 Ohne Griffe
 Sans poignées

Art-Nr./No d'article	Tiefe/profondeur	Inhalt/capacité	Preis/prix
8122.20080	65 mm	0,9 l	37.60
8122.20081	100 mm	1,4 l	44.65
8122.20082	150 mm	2,1 l	52.90
8122.20083	200 mm	2,8 l	62.30

8122.20180	Deckel mit Griffmulde Couvercle avec moulure centrale et poignées	22.95
8122.20181	Deckel mit Löffelausschnitt Couvercle avec découpes pour louche	31.70
8122.20182	Deckel mit Dichtung Couvercle étanche	91.60
8122.20183	Steckdeckel Couvercle encastrable	37.60



RIEBER
GN 1/6, 162 x 176 mm
 Mit versenkbaren Griffen
 Avec poignées escamotables

Art-Nr./No d'article	Tiefe/profondeur	Inhalt/capacité	Preis/prix
8122.21080	65 mm	0,9 l	61.15
8122.21081	100 mm	1,4 l	70.55
8122.21082	150 mm	2,1 l	82.10
8122.21083	200 mm	2,8 l	96.20

8122.21180	Deckel mit Griffaussparung Couvercle avec découpes pour poignées escamotables	32.90
8122.21181	Deckel mit Griff- u. Löffelaussparung Couvercle avec découpes poignées et louche	42.30



RIEBER
GN 1/9, 176 x 108 mm
 Ohne Griffe
 Sans poignées

Art-Nr./No d'article	Tiefe/profondeur	Inhalt/capacité	Preis/prix
8122.20090	65 mm	0,5 l	42.30
8122.20091	100 mm	0,7 l	44.65

8122.20190	Deckel mit Griffmulde Couvercle avec moulure centrale et poignées	25.85
8122.20191	Deckel mit Löffelausschnitt Couvercle avec découpes pour louche	34.65
8122.20192	Steckdeckel Couvercle encastrable	37.60



RIEBER
GN 1/9, 176 x 108 mm
 Mit versenkbaren Griffen
 Avec poignées escamotables

Art-Nr./No d'article	Tiefe/profondeur	Inhalt/capacité	Preis/prix
8122.21090	65 mm	0,5 l	63.50
8122.21091	100 mm	0,7 l	64.65

8122.21190	Deckel mit Griffaussparung Couvercle avec découpes pour poignées escamotables	34.65
8122.21191	Deckel mit Griff- u. Löffelaussparung Couvercle avec découpes poignées et louche	42.30





**«Easyline»
GN-Behälter, Inox
Bac GN, inox**

BEST PRICE

Art-Nr./No d'article	Tiefe/profondeur	Inhalt/capacité	Preis/prix
8582.81000	20 mm	5,0 L	58.80

GN 1/1, 325 x 530 mm

Art-Nr./No d'article	Tiefe/profondeur	Inhalt/capacité	Preis/prix
8582.81095	10 mm	1,25 L	21.15
8582.81100	20 mm	2,5 L	23.50
8582.81101	40 mm	5,0 L	25.85
8582.81109	55 mm	6,5 L	26.95
8582.81102	65 mm	9,0 L	28.20
8582.81104	100 mm	14,0 L	34.05
8582.81106	150 mm	21,0 L	51.70
8582.81108	200 mm	28,0 L	62.30

GN 1/2, 325 x 265 mm

Art-Nr./No d'article	Tiefe/profondeur	Inhalt/capacité	Preis/prix
8582.81200	20 mm	1,0 L	10.55
8582.81201	40 mm	2,0 L	14.80
8582.81209	55 mm	2,8 L	15.25
8582.81202	65 mm	4,0 L	16.40
8582.81204	100 mm	6,5 L	21.15
8582.81206	150 mm	9,5 L	32.90
8582.81208	200 mm	12,5 L	42.30

GN 1/3, 325 x 176 mm

Art-Nr./No d'article	Tiefe/profondeur	Inhalt/capacité	Preis/prix
8582.81300	20 mm	0,75 L	8.20
8582.81302	65 mm	2,5 L	11.70
8582.81304	100 mm	4,0 L	16.40
8582.81306	150 mm	5,7 L	22.30
8582.81308	200 mm	7,8 L	30.55

GN 1/4, 265 x 162 mm

Art-Nr./No d'article	Tiefe/profondeur	Inhalt/capacité	Preis/prix
8582.81400	20 mm	0,5 L	8.20
8582.81401	40 mm	1,0 L	9.35
8582.81402	65 mm	1,8 L	10.55
8582.81404	100 mm	2,8 L	14.05
8582.81406	150 mm	4,0 L	22.30
8582.81408	200 mm	5,5 L	26.95

GN 1/6, 162 x 176 mm

Art-Nr./No d'article	Tiefe/profondeur	Inhalt/capacité	Preis/prix
8582.81602	65 mm	1,0 L	8.20
8582.81604	100 mm	1,6 L	10.55
8582.81606	150 mm	2,4 L	17.60
8582.81608	200 mm	3,0 L	21.15

GN 1/9, 108 x 176 mm

Art-Nr./No d'article	Tiefe/profondeur	Inhalt/capacité	Preis/prix
8582.81502	65 mm	0,6 L	5.85
8582.81504	100 mm	1,0 L	9.35
8582.81506	150 mm	1,5 L	12.25

GN 2/3, 354 x 325 mm

Art-Nr./No d'article	Tiefe/profondeur	Inhalt/capacité	Preis/prix
8582.81700	20 mm	1,5 L	17.60
8582.81701	40 mm	3,0 L	22.30
8582.81702	65 mm	5,5 L	25.85
8582.81704	100 mm	9,0 L	34.05
8582.81706	150 mm	13,0 L	51.70
8582.81707	200 mm	18,0 L	54.05

GN 2/4, 162 x 530 mm

Art-Nr./No d'article	Tiefe/profondeur	Inhalt/capacité	Preis/prix
8582.81800	20 mm	1,2 L	14.05
8582.81801	40 mm	2,4 L	18.80
8582.81802	65 mm	3,6 L	22.30
8582.81804	100 mm	5,6 L	30.55
8582.81806	150 mm	8,7 L	37.60



**«Easyline»
Perforierte GN-Behälter
Bac GN perforée**

BEST PRICE

GN 1/1, 325 x 530 mm

Art-Nr./No d'article	Tiefe/profondeur	Preis/prix
8582.81911	40 mm	26.95
8582.81907	65 mm	28.20
8582.81908	100 mm	34.05
8582.81909	150 mm	51.70
8582.81910	200 mm	62.30

GN 1/2, 325 x 265 mm

Art-Nr./No d'article	Tiefe/profondeur	Preis/prix
8582.81901	65 mm	16.40
8582.81902	100 mm	21.15
8582.81903	150 mm	32.90
8582.81904	200 mm	43.50

GN 2/3, 354 x 325 mm

Art-Nr./No d'article	Tiefe/profondeur	Preis/prix
8582.81905	65 mm	26.95
8582.81906	100 mm	35.15

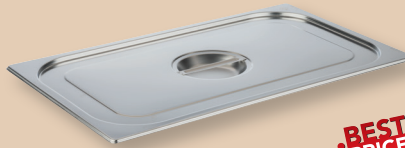

**«Easyline»
GN-Deckel
GN-Couvercle**

BEST PRICE

Art-Nr./No d'article	Grösse/grandeur	Preis/prix
8582.81195	GN 1/1	22.30
8582.81295	GN 1/2	11.70
8582.81395	GN 1/3	9.35
8582.81495	GN 1/4	8.20
8582.81695	GN 1/6	5.85
8582.81591	GN 1/9	4.95
8582.81795	GN 2/3	23.50
8582.81895	GN 2/4	17.60

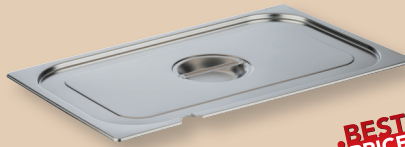

**«Easyline»
GN-Deckel mit Löffelaussparung
Couvercle GN avec découpes pour louche**

BEST PRICE

Art-Nr./No d'article	Grösse/grandeur	Preis/prix
8582.81191	GN 1/1	25.85
8582.81292	GN 1/2	12.25
8582.81391	GN 1/3	10.55
8582.81492	GN 1/4	9.35
8582.81692	GN 1/6	6.45
8582.81595	GN 1/9	5.85
8582.81791	GN 2/3	25.85
8582.81891	GN 2/4	18.80



BEST PRICE

**«Easyline»
GN Steck-Deckel
GN-Couvercle**

Silikondichtung, Griffmulde und Loch gegen Unterdruck, nicht über 100°C erwärmen, nicht für Kombidämpfer geeignet, nur für Schalen ab 100 mm Höhe.

Bourrage en silicone, creux pour poignée et trou contre dépressurisation, ne pas chauffer plus que 100°C, ne pas fait pour combi-steamer, seulement pour bacs à partir de 100 mm d'hauteur.

Art-Nr./No d'article	Grösse/grandeur	Preis/prix
8582.80023	GN 1/1	56.40
8582.80024	GN 1/2	34.65
8582.80025	GN 1/3	30.55
8582.80026	GN 1/4	25.40
8582.80027	GN 1/6	21.85
8582.80028	GN 2/4	50.55
8582.80029	GN 2/3	55.25

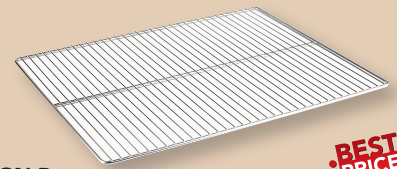

**GN-Roste
Grilles GN**

BEST PRICE

Art-Nr./No d'article	Grösse/grandeur	Preis/prix
8582.81199	GN 2/1 - 65,0 x 53,0 cm	66.95
8582.81198	GN 1/1 - 53,0 x 32,5 cm	31.70
8582.81296	GN 1/2 - 32,5 x 26,5 cm	17.60
8582.81796	GN 2/3 - 32,5 x 35,4 cm	22.30

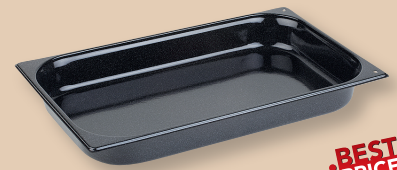

BEST PRICE

**GN-Konvektomatenblech, emailliert
Tôle GN pour four à convection, émaillée**

Sehr schwere Qualität. Beidseitig beschichtet mit hochtemperaturfähiger Granitemaille.

Qualité lourde, pelliculé double face avec émail de granite capable à haute températures

GN 1/1, 325 x 530 mm

Art-Nr./No d'article	Tiefe/profondeur	Preis/prix
8006.40641	20 mm	30.55
8006.40642	40 mm	33.75
8006.40643	65 mm	35.05

GN 1/2, 325 x 265 mm

Art-Nr./No d'article	Tiefe/profondeur	Preis/prix
8006.40640	40 mm	24.90
8006.40645	65 mm	26.95

GN 1/3, 325 x 176 mm

Art-Nr./No d'article	Tiefe/profondeur	Preis/prix
8006.40650	65 mm	24.90

GASTRONORM / GASTRONORME

GN-Behälter Porzellan
Bac GN en porcelaine
GN 1/1, 325 x 530 mm

Art-Nr./No d'article	Tiefe/profondeur	Preis/prix
8001.55511	65 mm	129.35

GN 2/4, 162 x 530 mm

Art-Nr./No d'article	Tiefe/profondeur	Preis/prix
8001.55708	65 mm	85.75

GN 2/3, 325 x 354 mm

Art-Nr./No d'article	Tiefe/profondeur	Preis/prix
8001.55518	65 mm	62.30

GN 1/2, 325 x 265 mm

Art-Nr./No d'article	Tiefe/profondeur	Preis/prix
8001.55512	65 mm	46.90

GN 1/3, 325 x 176 mm

Art-Nr./No d'article	Tiefe/profondeur	Preis/prix
8001.55519	65 mm	34.65

GN 1/4, 162 x 265 mm

Art-Nr./No d'article	Tiefe/profondeur	Preis/prix
8001.55520	65 mm	30.20

GN 1/6, 162 x 176 mm

Art-Nr./No d'article	Tiefe/profondeur	Preis/prix
8001.55521	65 mm	23.50

GN-Platte Porzellan
Bac GN en porcelaine
GN 1/1, 325 x 530 mm

Art-Nr./No d'article	Tiefe/profondeur	Preis/prix
8001.55510	20 mm	109.85

GN 2/4, 162 x 530 mm

Art-Nr./No d'article	Tiefe/profondeur	Preis/prix
8001.55522	20 mm	74.95

GN 2/3, 325 x 354 mm

Art-Nr./No d'article	Tiefe/profondeur	Preis/prix
8001.55523	20 mm	57.60

GN 1/2, 325 x 265 mm

Art-Nr./No d'article	Tiefe/profondeur	Preis/prix
8001.55524	20 mm	42.30

GN 1/3, 325 x 176 mm

Art-Nr./No d'article	Tiefe/profondeur	Preis/prix
8001.55525	20 mm	30.20

GN 1/4, 162 x 265 mm

Art-Nr./No d'article	Tiefe/profondeur	Preis/prix
8001.55526	20 mm	29.35

GN 1/6, 162 x 176 mm

Art-Nr./No d'article	Tiefe/profondeur	Preis/prix
8001.55527	20 mm	21.15

GN-Behälter Porzellan
Bac GN en porcelaine

Weiss, geeignet für Backofen und Mikrowelle, spülmaschinenfest
 Blanc, convient au four et au micro-ondes ainsi qu'au lave-vaisselle

GN 1/1, 325 x 530 mm

Art-Nr./No d'article	Tiefe/profondeur	Preis/prix
8582.82100	65 mm	92.80

GN 1/2, 325 x 265 mm

Art-Nr./No d'article	Tiefe/profondeur	Preis/prix
8582.82100	65 mm	43.50

GN 1/3, 325 x 176 mm

Art-Nr./No d'article	Tiefe/profondeur	Preis/prix
8582.82300	65 mm	33.50

GN 2/4, 530 x 162 mm

Art-Nr./No d'article	Tiefe/profondeur	Preis/prix
8582.82301	65 mm	58.80

GN 2/3, 354 x 325 mm

Art-Nr./No d'article	Tiefe/profondeur	Preis/prix
8582.82306	65 mm	62.30



Bestecksammler GN 1/3
Collecteur de couverts GN 1/3

Art-Nr./No d'article	Grösse/grandeur	Preis/prix
8582.11978	32,5 x 17,5 x H 15 cm	38.80

Abfallbehälter
Collecteur de déchets

Inox, mit 2 Haken zum Einhängen an Servier- oder Transportwagen, schwere Qualität
 Acier inoxydable, avec 2 crochets pour accrocher au chariot de transport ou de service, qualité lourde

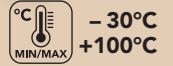
Art-Nr./No d'article	Grösse/grandeur	Preis/prix
8006.42330	18 x 23 x H 18,5 cm	82.10

GN-Behälter Polycarbonat
Bacs Gastronorme en polycarbonat

schwarz, aussen graduiert
 noir, graduée en externe

GN 1/1, 325 x 530 mm

Art-Nr./No d'article	Tiefe/profondeur	Inhalt/capacité	Preis/prix
8006.40900	65 mm	8,3 l	32.30
8006.40901	100 mm	13 l	40.65
8006.40902	150 mm	19,5 l	44.65

GN 1/2, 325 x 265 mm

Art-Nr./No d'article	Tiefe/profondeur	Inhalt/capacité	Preis/prix
8006.40903	65 mm	3,96 l	15.25
8006.40904	100 mm	6,15 l	17.95
8006.40905	150 mm	9,16 l	24.90

GN 1/3, 325 x 176 mm

Art-Nr./No d'article	Tiefe/profondeur	Inhalt/capacité	Preis/prix
8006.40906	65 mm	2,71 l	11.70
8006.40907	100 mm	4,1 l	13.95
8006.40908	150 mm	5,43 l	18.80

GN 1/4, 162 x 265 mm

Art-Nr./No d'article	Tiefe/profondeur	Inhalt/capacité	Preis/prix
8006.40909	65 mm	1,73 l	9.35
8006.40910	100 mm	2,89 l	10.55
8006.40911	150 mm	3,72 l	15.25

GN 1/6, 162 x 176 mm

Art-Nr./No d'article	Tiefe/profondeur	Inhalt/capacité	Preis/prix
8006.40912	65 mm	0,85 l	6.80
8006.40913	100 mm	1,56 l	7.95
8006.40914	150 mm	2,25 l	11.70

GN 1/9, 108 x 176 mm

Art-Nr./No d'article	Tiefe/profondeur	Inhalt/capacité	Preis/prix
8006.40915	100 mm	1,06 l	5.85

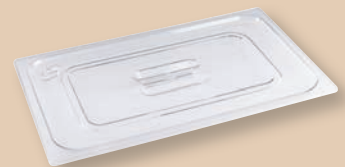
GN-Auflagedeckel, polycarbonat
GN-Couvercle, polycarbonat

Art-Nr./No d'article	Grösse/grandeur	Preis/prix
8006.40920	GN 2/1	54.05
8006.40921	GN 1/1	19.95
8006.40922	GN 1/2	10.55
8006.40923	GN 1/3	7.95
8006.40924	GN 1/4	6.55
8006.40925	GN 1/6	4.90
8006.40926	GN 1/9	3.45



Melamin
Mélangine



- 40°C
+ 90°C

GN-Platten & Behälter aus Melamin
Bacs et plats Gastronorme en mélamine

Melamin
extrem bruchsicher
glänzende und harte Oberfläche
spülmaschinen- und tiefkühlfest lebensmittelecht,
hygienisch, geruchs- und geschmacksneutral
nicht für den Backofen geeignet
keinen Temperaturschocks unterziehen
Nicht auf heißen Flächen liegen lassen!
hitzebeständig: max. 15 Minuten bei 100° C

Mélangine
haute force de rupture
Surface brillante et dure
Convient au lave-vaisselle et congélateur,
hygiénique, inodore et sans goût.
Ne résiste pas au four
Ne pas soumettre à des chocs de température
Ne pas laisser sur une surface chaude.
Résistant à la chaleur: max. 15 minutes à 100°C

Buffetplatte GN, Melamin
Plate à buffet GN, mélamine

GN 1/1, 325 x 530 mm x H 20 mm

Art-Nr./No d'article	Tiefe/profondeur	Preis/prix
8582.83401	H 20 mm	66.95
8582.83479	H 20 mm	66.95

GN 1/2, 325 x 265 mm x H 20 mm

Art-Nr./No d'article	Tiefe/profondeur	Preis/prix
8582.83480	H 20 mm	35.15
8582.83490	H 20 mm	35.15

GN 1/3, 325 x 175 mm x H 20 mm

Art-Nr./No d'article	Tiefe/profondeur	Preis/prix
8582.83481	H 20 mm	31.70
8582.83491	H 20 mm	31.70

GN 1/4, 162 x 265 mm x H 20 mm

Art-Nr./No d'article	Tiefe/profondeur	Preis/prix
8582.83482	H 20 mm	18.80
8582.83492	H 20 mm	18.80

GN 2/4, 162 x 530 mm x H 20 mm

Art-Nr./No d'article	Tiefe/profondeur	Preis/prix
8582.83433	H 20 mm	38.80
8582.83434	H 20 mm	38.80

GN-Behälter
Bac-gastronormé

GN 1/1, 325 x 530 mm

Art-Nr./No d'article	Tiefe/profondeur	Preis/prix
8582.83759	65 mm	50.55
8582.84300	100 mm	56.40
8582.83758	65 mm	50.55
8582.84306	100 mm	56.40
8582.82001	Deckel/Couvercle	17.40

GN 1/2, 325 x 265 mm

Art-Nr./No d'article	Tiefe/profondeur	Preis/prix
8582.83757	65 mm	28.90
8582.84301	100 mm	34.65
8582.83756	65 mm	28.90
8582.84307	100 mm	34.65
8582.82013	Deckel/Couvercle	9.85

GN 2/4, 162 x 530 mm

Art-Nr./No d'article	Tiefe/profondeur	Preis/prix
8582.83755	65 mm	33.50
8582.84302	100 mm	41.15
8582.83754	65 mm	33.50
8582.84308	100 mm	41.15

GN 1/3, 325 x 175 mm

Art-Nr./No d'article	Tiefe/profondeur	Preis/prix
8582.83753	65 mm	24.90
8582.84303	100 mm	28.90
8582.83752	65 mm	24.90
8582.84309	100 mm	28.90
8582.82019	Deckel/Couvercle	8.20

GN 1/4, 162 x 265 mm

Art-Nr./No d'article	Tiefe/profondeur	Preis/prix
8582.83751	65 mm	21.15
8582.84304	100 mm	25.85
8582.83750	65 mm	21.15
8582.84310	100 mm	25.85
8582.82029	Deckel/Couvercle	6.95

GN 1/6, 162 x 176 mm

Art-Nr./No d'article	Tiefe/profondeur	Preis/prix
8582.83749	65 mm	17.60
8582.84305	100 mm	18.80
8582.83748	65 mm	17.60
8582.84311	100 mm	18.80
8582.82037	Deckel/Couvercle	4.90

GASTRONORM / GASTRONORME



- 30°C
+ 100°C



Polycarbonat

HUPFER
GN-Polycarbonatschalen
Bacs Gastronorme en polycarbonat

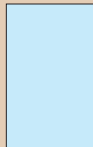

GN 1/1, 325 x 530 mm

Art-Nr./No d'article	Tiefe/profondeur	Inhalt/capacité	Preis/prix
01.3062.2 P	65 mm	7,0 l	28.90
01.3063.2 P	100 mm	12,0 l	34.65
01.3064.2 P	150 mm	18,0 l	42.30
01.3065.2 P	200 mm	24,0 l	50.55

01.3164.2 P	Deckel/Couvercle	21.85
01.3252.2 P	Einlegeboden/Fond	13.95



GN 1/2, 325 x 265 mm

Art-Nr./No d'article	Tiefe/profondeur	Inhalt/capacité	Preis/prix
01.3077.2 P	65 mm	3,5 l	17.40
01.3078.2 P	100 mm	5,5 l	18.80
01.3079.2 P	150 mm	8,0 l	23.50
01.3080.2 P	200 mm	11,0 l	27.75

01.3165.2 P	Deckel/Couvercle	13.25
01.3253.2 P	Einlegeboden/Fond	8.90



GN 2/1, 650 x 530 mm

Art-Nr./No d'article	Tiefe/profondeur	Inhalt/capacité	Preis/prix
01.3065.3 P	200 mm	48 l	112.30

01.3065.4 P	Deckel/Couvercle	50.55
01.3065.5 P	Einlegeboden/Fond	50.55

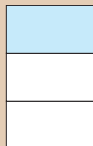

GN 1/3, 325 x 176 mm

Art-Nr./No d'article	Tiefe/profondeur	Inhalt/capacité	Preis/prix
01.3305.2 P	65 mm	2,0 l	13.50
01.3138.2 P	100 mm	3,2 l	15.25
01.3139.2 P	150 mm	5,0 l	19.15
01.3304.2 P	200 mm	7,0 l	22.95

01.3170.2 P	Deckel/Couvercle	10.55
--------------------	------------------	--------------



GN 1/4, 162 x 265 mm

Art-Nr./No d'article	Tiefe/profondeur	Inhalt/capacité	Preis/prix
01.3303.2 P	65 mm	1,5 l	10.55
01.3103.2 P	100 mm	2,2 l	11.70
01.3104.2 P	150 mm	3,6 l	13.85
01.3302.2 P	200 mm	5,0 l	14.55

01.3167.2 P	Deckel/Couvercle	8.90
--------------------	------------------	-------------

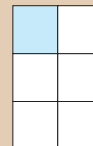

GN 1/6, 162 x 176 mm

Art-Nr./No d'article	Tiefe/profondeur	Inhalt/capacité	Preis/prix
01.3306.2 P	65 mm	0,9 l	7.95
01.3151.2 P	100 mm	1,4 l	9.85
01.3152.2 P	150 mm	2,1 l	11.25
01.3303.3 P	200 mm	2,8 l	11.70

01.3171.2 P	Deckel/Couvercle	6.95
--------------------	------------------	-------------

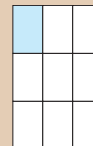

GN 1/9, 108 x 176 mm

Art-Nr./No d'article	Tiefe/profondeur	Inhalt/capacité	Preis/prix
01.3308.2 P	65 mm	0,5 l	6.10
01.3307.2 P	100 mm	0,7 l	6.80

01.3309.2 P	Deckel/Couvercle	4.90
--------------------	------------------	-------------

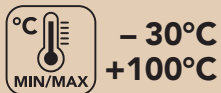

**BEST
SELLER**



**Schwappsichere Deckel zu unschlagbaren Preisen!
Couvercles hermetiques pour des prix imbattables!**

**GN-Polycarbonatschalen
Bacs Gastronorme en polycarbonat**

Hochgradig beanspruchbarer Kunststoff. Ist gegen Salzlösungen, Laugen und Säuren weitgehend beständig.

Matière synthétique très connu (est utilisé, entre autres, pour les fameuses pièces LEGO). Existe en apparence transparente ou colorée. Belle surface brillante.



**Araven Stift
Araven Stylo**
Einfache Reinigung/Facile à effacer
Art-Nr./No d'article
8310.39301 schwarz/noir **7.25**



permanentes Label
Label permanent



GN 1/1, 325 x 530 mm

Art-Nr./No d'article	Tiefe/profondeur	Inhalt/capacité	Preis/prix
8310.00010	65 mm	9,0 l	35.10
8310.00011	100 mm	13,0 l	42.30
8310.00012	150 mm	20,0 l	55.25
8310.00013	200 mm	15,3 l	58.80

Deckel hermetisch/Couvercle hermetique
8310.00014 22 mm GN 1/1 **21.15**

Deckel transparent/Couvercle
8310.00015 20 mm GN 1/1 **31.70**



GN 1/2, 325 x 265 mm

Art-Nr./No d'article	Tiefe/profondeur	Inhalt/capacité	Preis/prix
8310.00020	65 mm	3,8 l	23.50
8310.00021	100 mm	6,0 l	28.20
8310.00022	150 mm	9,5 l	32.30
8310.00023	200 mm	11,3 l	35.15

Deckel hermetisch/Couvercle hermetique
8310.00024 22 mm GN 1/2 **13.50**

Deckel transparent/Couvercle
8310.00025 20 mm GN 1/2 **18.80**



GN 1/3, 325 x 176 mm

Art-Nr./No d'article	Tiefe/profondeur	Inhalt/capacité	Preis/prix
8310.00030	65 mm	2,5 l	18.80
8310.00031	100 mm	4,0 l	19.50
8310.00032	150 mm	6,0 l	22.95
8310.00033	200 mm	6,7 l	28.20

Deckel hermetisch/Couvercle hermetique
8310.00034 22 mm GN 1/3 **11.25**

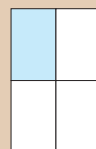

GN 1/4, 162 x 265 mm

Art-Nr./No d'article	Tiefe/profondeur	Inhalt/capacité	Preis/prix
8310.00040	65 mm	1,8 l	15.25
8310.00041	100 mm	2,8 l	17.15
8310.00042	150 mm	4,3 l	19.75

Deckel hermetisch/Couvercle hermetique
8310.00044 22 mm GN 1/4 **9.85**

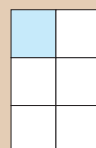

GN 1/6, 162 x 176 mm

Art-Nr./No d'article	Tiefe/profondeur	Inhalt/capacité	Preis/prix
8310.00050	65 mm	1,1 l	11.70
8310.00051	100 mm	1,7 l	13.25
8310.00052	150 mm	2,15 l	15.25

Deckel hermetisch/Couvercle hermetique
8310.00054 22 mm GN 1/6 **7.95**

GASTRONORM / GASTRONORME



- 30°C
+ 75°C



Polypropylen
polypropylène

HUPFER GN-Polypropylenschalen Bacs Gastronorme en polypropylène

Hygienisch, absolut geruchs- und geschmacksneutral, schwappsicherer Clipdeckel, im Gegensatz zu herkömmlichen Kunststoff-GN-Schalen bruchfest und schlagzäh auch im Tiefkühlbereich.

Hygiénique, neutre au goût et absolument inodore, couvercle clip pour éviter le débordement, contraire aux autres produits synthétiques Gatsronorme résistant à la casse et aux chocs, aussi dans le domaine du congelé.



GN 1/1, 325 x 530 mm

Art-Nr./No d'article	Tiefe/profondeur	Inhalt/capacité	Preis/prix
PR11065	65 mm	7 l	18.80
PR11100	100 mm	12 l	19.15
PR11150	150 mm	18 l	23.50
PR11200	200 mm	26 l	27.75
PRC11	Deckel/Couvercle		13.95
PRFFF11	Einlegeboden gelocht Fond perforé		11.25



GN 1/2, 325 x 265 mm

Art-Nr./No d'article	Tiefe/profondeur	Inhalt/capacité	Preis/prix
PR12065	65 mm	3,5 l	9.85
PR12100	100 mm	6,0 l	10.55
PR12150	150 mm	8,5 l	11.40
PR12200	200 mm	12 l	14.80
PRC12	Deckel/Couvercle		8.20
PRFFF12	Einlegeboden gelocht Fond perforé		8.20

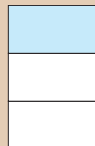

GN 1/3, 325 x 176 mm

Art-Nr./No d'article	Tiefe/profondeur	Inhalt/capacité	Preis/prix
PR13065	65 mm	2 l	8.90
PR13100	100 mm	3 l	9.85
PR13150	150 mm	5 l	11.70
PR13200	200 mm	6 l	13.25
PRC13	Deckel/Couvercle		7.95

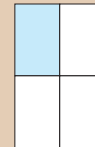

GN 1/4, 162 x 265 mm

Art-Nr./No d'article	Tiefe/profondeur	Inhalt/capacité	Preis/prix
PR14065	65 mm	1,5 l	7.95
PR14100	100 mm	2,2 l	8.90
PR14150	150 mm	3,6 l	10.55
PR14200	200 mm	5,0 l	11.25
PRC14	Deckel/Couvercle		7.25

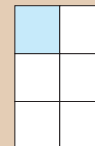

GN 1/6, 162 x 176 mm

Art-Nr./No d'article	Tiefe/profondeur	Inhalt/capacité	Preis/prix
PR16065	65 mm	0,9 l	6.80
PR16100	100 mm	1,4 l	7.25
PR16150	150 mm	2,1 l	8.90
PR16200	200 mm	2,8 l	9.30
PRC16	Deckel/Couvercle		5.85

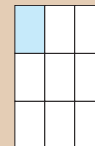

GN 1/9, 108 x 176 mm

Art-Nr./No d'article	Tiefe/profondeur	Inhalt/capacité	Preis/prix
PR19065	65 mm	0,5 l	5.40
PR19100	100 mm	0,7 l	5.85
PRC19	Deckel/Couvercle		4.90



GN-Frischhaltebox mit Deckel
GN-Box fraîcheur avec couvercle

Polypropylen, transparent, stapelbar, luftdicht verschliessbar, gefriertruhen- und mikrowellengeeignet, spülmaschinenfest, geschmacks- und geruchsneutral
Farbcodesystem: 2 x 4 Klammern in grün, gelb, blau und rot, gemäss HACCP-Normen werden mitgeliefert (passend für Deckel und Behälter).

Polypropylène, transparent, empilable, étanche fermable, convient au congélateur et micro-onde, concient au lave-vaisselle, neutre de goût et d'odeur
Système code couleur: livraison avec 2 x 4 clips en vert, jaune, bleu et rouge selon les normes HACCP (pour le couvercle et récipient)



Araven Stift
Araven Stylo

Einfache Reinigung/Facile à effacer

Art-Nr./No d'article 8310.39301 schwarz/noir Preis/prix 7.25



permanentes Label
Label permanent



GN 1/1, 325 x 530 mm

Deckel und Behälter/Couvercle et récipient

Art-Nr./No d'article	Tiefe/profondeur	Inhalt/capacité	Preis/prix
8582.82417	150 mm	21 l	45.85
8582.82418	200 mm	28 l	51.70



GN 1/2, 325 x 265 mm

Deckel und Behälter/Couvercle et récipient

Art-Nr./No d'article	Tiefe/profondeur	Inhalt/capacité	Preis/prix
8582.82412	100 mm	6,5 l	27.75
8582.82413	150 mm	10,0 l	32.30
8582.82414	200 mm	12,5 l	36.95

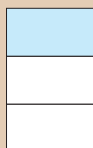

GN 1/3, 325 x 176 mm

Deckel und Behälter/Couvercle et récipient

Art-Nr./No d'article	Tiefe/profondeur	Inhalt/capacité	Preis/prix
8582.82409	65 mm	2,5 l	16.10
8582.82410	100 mm	4,0 l	19.50
8582.82411	150 mm	6,0 l	21.15



GN 1/4, 162 x 265 mm

Deckel und Behälter/Couvercle et récipient

Art-Nr./No d'article	Tiefe/profondeur	Inhalt/capacité	Preis/prix
8582.82406	65 mm	1,8 l	11.70
8582.82407	100 mm	2,8 l	13.95
8582.82408	150 mm	4,3 l	14.80

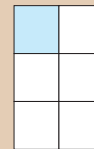

GN 1/6, 162 x 176 mm

Deckel und Behälter/Couvercle et récipient

Art-Nr./No d'article	Tiefe/profondeur	Inhalt/capacité	Preis/prix
8582.82403	65 mm	1,1 l	9.35
8582.82404	100 mm	1,7 l	10.55
8582.82405	150 mm	2,6 l	11.70

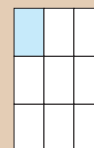

GN 1/9, 108 x 176 mm

Deckel und Behälter/Couvercle et récipient

Art-Nr./No d'article	Tiefe/profondeur	Inhalt/capacité	Preis/prix
8582.82400	65 mm	0,6 l	7.50
8582.82401	100 mm	1,0 l	8.90
8582.82402	150 mm	1,5 l	10.55

GASTRONORM / GASTRONORME



- 40°C
+ 190°C

CAMBRO H-Pan GN-Schalen Bacs Gastronorme H-Pan

Diese hitzebeständigen GN-Behälter sind wandlungsfähig und passen sich unterschiedlichen Temperaturen an (kalt und heiß), und sie können bei Temperaturen bis zu 190 °C sicher eingesetzt werden. Die hitzebeständigen GN-Behälter können vom Kühlraum in den Ofen und auf den Dampftisch benutzt werden und reduzieren so die unnötige Handhabung. Außerdem eignen sie sich hervorragend zum Einfrieren, Kochen und Aufwärmen. Das System kann mit transparenten Deckeln, Ablaufschalen und Siebschalen vervollständigt werden. Diese hitzebeständigen Schalen und Zubehörteile halten Temperaturen von -40 °C bis 190 °C stand und sind im Gegensatz zu Metallschalen auch für die Mikrowelle geeignet.

Ces bacs hautes températures sont modulables et adaptés à différentes températures, du froid au chaud. Ils s'utilisent sans danger dans diverses applications culinaires jusqu'à 190 °C. Les bacs hautes températures peuvent passer directement de la zone de préparation au réfrigérateur puis au four ou sur la table à vapeur, limitant ainsi les manipulations inutiles. Ils sont aussi parfaits pour congeler, cuire ou réchauffer. Vous pouvez les compléter avec des couvercles transparents hautes températures, des bacs-égouttoirs et des bacs perforés assortis. Ces bacs et les accessoires acceptent des températures comprises entre -40 °C et 190 °C, et contrairement aux bacs métalliques, ils s'utilisent dans les fours à micro-ondes.



GN 1/1, 325 x 530 mm

Art-Nr./No d'article	Tiefe/profondeur	Inhalt/capacité	Preis/prix
8323.80005	65 mm	8,5 l	98.55
8323.80010	100 mm	13 l	117.25
8323.80015	150 mm	19,5 l	152.90
8323.80020	Deckel/Couvercle		89.90

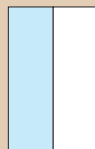

GN 2/4, 325 x 265 mm

Art-Nr./No d'article	Tiefe/profondeur	Inhalt/capacité	Preis/prix
8323.80125	65 mm	3 l	72.65
8323.80130	100 mm	5 l	86.90
8323.80135	Deckel/Couvercle		51.70



GN 1/2, 325 x 265 mm

Art-Nr./No d'article	Tiefe/profondeur	Inhalt/capacité	Preis/prix
8323.80025	65 mm	3,9 l	49.35
8323.80030	100 mm	5,9 l	64.65
8323.80035	150 mm	8,9 l	82.10
8323.80040	Deckel/Couvercle		38.20

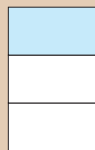

GN 1/3, 325 x 176 mm

Art-Nr./No d'article	Tiefe/profondeur	Inhalt/capacité	Preis/prix
8323.80045	65 mm	2,4 l	42.30
8323.80050	100 mm	3,6 l	56.40
8323.80055	150 mm	5,3 l	72.65
8323.80060	Deckel/Couvercle		28.20



GN 1/4, 162 x 265 mm

Art-Nr./No d'article	Tiefe/profondeur	Inhalt/capacité	Preis/prix
8323.80065	65 mm	1,7 l	35.15
8323.80070	100 mm	2,5 l	45.85
8323.80075	150 mm	3,7 l	58.80
8323.80080	Deckel/Couvercle		22.95

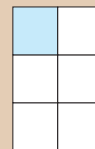

GN 1/6, 162 x 176 mm

Art-Nr./No d'article	Tiefe/profondeur	Inhalt/capacité	Preis/prix
8323.80085	65 mm	1 l	28.20
8323.80090	100 mm	1,5 l	34.65
8323.80095	150 mm	2,2 l	46.90
8323.80100	Deckel/Couvercle		21.15

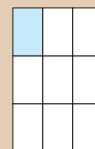

GN 1/9, 108 x 176 mm

Art-Nr./No d'article	Tiefe/profondeur	Inhalt/capacité	Preis/prix
8323.80105	65 mm	0,57 l	21.15
8323.80110	100 mm	0,85 l	23.50
8323.80115	150 mm	1,4 l	35.15
8323.80120	Deckel/Couvercle		13.95

FOOD-BOXEN / BOXES À FOOD



GN-Zutatenbehälter GN-Bac pour ingrédients

Behälter zur Aufbewahrung trockener Lebensmittel. Die Behälter sind mit dem FIFO-System (first in-first out) ausgestattet. So haben diese hinten einen Deckel zum Befüllen und vorne eine Deckel zum Entnehmen von Lebensmitteln.
Réceptacle de stockage pour aliments secs. Les boîtes sont conçues avec le système FIFO (first in-first out). Le couvercle à double ouverture permet de remplir les ingrédients par l'arrière et de les prélever par l'avant.

GN 1/1, 565 x 340 mm

Art-Nr./No d'article	Höhe/hauteur	Inhalt/capacité	Preis/prix
8310.00801	200 mm	23 L	44.65
8310.00802	400 mm	50 L	86.90

GN 1/3, 395 x 200 mm

Art-Nr./No d'article	Höhe/hauteur	Inhalt/capacité	Preis/prix
8310.00803	200 mm	7 L	19.50

GN 2/3, 415 x 340 mm

Art-Nr./No d'article	Höhe/hauteur	Inhalt/capacité	Preis/prix
8310.00804	200 mm	16 L	38.20



Zutatenbehälter mit Schiebedeckel Bac avec couvercle coulissant

Behälter zur Aufbewahrung trockener Lebensmittel. Mit resistenten Polyamid-Rollen und transparentem Schiebedeckel.
Réceptacle pour conserver les aliments secs. Avec roulettes résistantes en polyamide et couvercle coulissant transparent.

Art-Nr./No d'article	Grösse/grandeur	Preis/prix
8310.00805	80 L / 65,5 x 43,5 x H 56 cm	206.95
8310.00806	100 L / 70,5 x 46,5 x H 58 cm	223.45

Zubehör/Accessoires

8310.00807	Schaufel Robinet de rechange 95 cl / 28 x 12 cm	13.25
------------	---	-------



Lebensmittel-Transportbehälter Conteneur de transport alimentaire

Behälter mit Deckel zum Transport von Lebensmitteln. Integrierte permanente Etikette, Color-Clip um Verwechslungen der verschiedenen Nahrungsmittel zu vermeiden, leer oder mit Deckel stapelbar, seitliche Griffe mit Klammer für einfache Handhabung und Transport
Bac avec couvercle pour le transport des denrées alimentaires. L'étiquette permanente ColorClip intégrée permet d'éviter les contaminations croisées, empilable avec couvercle et emboîtable à vide, poignées latérales à fermeture pour faciliter la manipulation et le transport.

Art-Nr./No d'article	Höhe/hauteur	Inhalt/capacité	Preis/prix
8310.00810	40 L / 83 x 46 x H 18 cm		84.55
8310.00820	30 L / 53 x 39,6 x H 15,9 cm		50.55
8310.00830	40 L / 53 x 39,6 x H 22,5 cm		56.40
8310.00840	60 L / 53 x 39,6 x H 37,8 cm		104.20

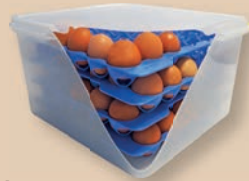

GN-Eierbox Bac GN pour œufs

Eierbehälter zur verschlossenen Aufbewahrung im Kühlraum. Inklusive 4 Eiereinsätze für je 30 Eier.
Casier à œufs pour conservation hermétique en réfrigérateur. 4 supports inclus pouvant contenir 30 œufs chacun.

GN 2/3, 354 x 325 mm

Art-Nr./No d'article	Höhe/hauteur	Inhalt/capacité	Preis/prix
8310.00881	200 mm	9 L	46.80



Flüssigkeitendispenser Distributeur de liquides

mit einstellbarem Ablaufhahn, mit Messskala, inkl. Farbclip, seitliche Tragegriffe.
avec robinet réglable doté d'une échelle graduée, d'attaches colorées et de poignées latérales.

Art-Nr./No d'article	Grösse/grandeur	Preis/prix
8310.00885	18 L / 285 x 285 x H 320 mm	79.85

Ersatzteile/Pièces de rechange

8310.00886	Ersatz-Ablaufhahn Robinet de rechange	23.50
------------	--	-------



«Bactainer» Lebensmittel-Transportbehälter Conteneur de transport alimentaire

Der BACTAINER ist nahezu unverwundlich, hat eine glatte, leicht zu reinigende Oberfläche, ist lebensmittelecht und dank der leichten V-Form ineinander stapelbar. Polyethylen, lebensmittelecht, bnehmbarer Deckel mit 1/2 Öffnung, mit integriertem Ablaufhahn (3/4 Zoll), stapelbar, 2Lenk- und 2 Bockrollen Ø100 mm (180 L) / Ø150 mm (360 L)
BACTAINER peut avoir plusieurs utilisations. C'est un container étanche très solide. Grâce à sa forme en V, il est empilable. Structure étanche en PE rigide sur châssis de fixation de roulettes en acier, couvercle amovible et articulé sur une charnière inox, bonde de vidange, empilable, 2 roulettes fixes et 2 pivotantes Ø100 mm (180 L) / Ø150 mm (360 L)

Art-Nr./No d'article	Grösse/grandeur	Preis/prix
8490.00160	180 L / 84 x 64 x H 69 cm	939.85
8490.00165	360 L / 115 x 73 x H 82 cm	1352.90



Lebensmittel-Transportbehälter Conteneur de transport alimentaire

Behälter mit Deckel für die Aufbewahrung und den Transport von Lebensmitteln mit hohem Wassergehalt wie Obst und Gemüse. Die Lüftungsluke gewährleistet die Luftzirkulation beim Transport und verringert Kondensation. Resistente Polyamid-Rollen. Mit Deckel stapelbar.
Bac avec couvercle pour la conservation et le transport des produits alimentaires avec une forte teneur en eau, tels que les fruits et légumes. L'ouverture d'aération garantit une circulation d'air durant le transport et réduit la condensation. Roulettes résistantes en polyamide. Empilable avec couvercle.

Art-Nr./No d'article	Grösse/grandeur	Preis/prix
8310.00860	70 L / 65,5 x 43,5 x H 45,5 cm	112.30
8310.00870	90 L / 70,5 x 46,5 x H 48 cm	136.50

KONDITIONUTENSILIEN / USTENSILES DE PÂTISSERIES



Backblech rund Plaque à gâteau ronde

glatter Rand, Exopan antihaft-beschichtet
bord lisse, revêtement Exopan, anti-adhésif

Art-Nr./No d'article	Grösse/grandeur	Preis/prix
8006.90621	Ø 12 cm x H 2,1 cm	11.25
8006.90622	Ø 14 cm x H 2,2 cm	12.25
8006.90623	Ø 16 cm x H 2,2 cm	16.40
8006.90624	Ø 18 cm x H 2,3 cm	17.40
8006.90625	Ø 20 cm x H 2,3 cm	21.15
8006.90626	Ø 22 cm x H 2,3 cm	23.50
8006.90627	Ø 24 cm x H 2,3 cm	25.85
8006.90628	Ø 26 cm x H 2,3 cm	29.60
8006.90629	Ø 28 cm x H 2,3 cm	30.55
8006.90630	Ø 30 cm x H 2,5 cm	34.65
8006.90631	Ø 32 cm x H 2,7 cm	39.95



«Exal» Rundes Blaublech Plaque à gâteau ronde

mit Exal-Beschichtung, Höchsttemperatur 250°C
avec revêtement Exal, Température maximum
250°C

Art-Nr./No d'article	Grösse/grandeur	Preis/prix
8006.90775	Ø 24 cm	31.70
8006.90776	Ø 26 cm	34.65
8006.90777	Ø 28 cm	41.15
8006.90778	Ø 30 cm	44.65
8006.90779	Ø 32 cm	45.85



«Exopan» Backform rund Manque rond

glatter Rand, Exopan antihaft-beschichtet
bord lisse, revêtement Exopan anti-adhésif

Art-Nr./No d'article	Grösse/grandeur	Preis/prix
8006.90650	Ø 10 cm x H 3,0 cm	10.55
8006.90651	Ø 12 cm x H 3,2 cm	13.25
8006.90652	Ø 14 cm x H 3,5 cm	15.25
8006.90653	Ø 16 cm x H 3,7 cm	16.40
8006.90654	Ø 18 cm x H 4,0 cm	19.95
8006.90655	Ø 20 cm x H 4,0 cm	23.50
8006.90656	Ø 22 cm x H 4,2 cm	25.85
8006.90657	Ø 24 cm x H 4,2 cm	28.20
8006.90658	Ø 26 cm x H 4,5 cm	30.55
8006.90659	Ø 28 cm x H 4,5 cm	34.05
8006.90660	Ø 30 cm x H 4,7 cm	41.15
8006.90661	Ø 32 cm x H 5,0 cm	44.65
8006.90662	Ø 34 cm x H 5,2 cm	51.70
8006.90663	Ø 36 cm x H 5,5 cm	54.05



«Exoglass®» Moule-Formen Moule à Quiche

Starre Form, leicht auslegbar, gleichmässiges
Backen, formbeständig, antihaft-beschichtet
Forme rigide facile à foncer, cuisson homogène
de la pâte, revêtement anti-adhésif

Art-Nr./No d'article	Grösse/grandeur	Preis/prix
8006.90862	Ø 9 cm x H 2 cm	12 pcs. 76.20 (6.35 p.pc)
8006.90863	Ø 12 cm x H 2 cm	12 pcs. 104.20 (8.69 p.pc)

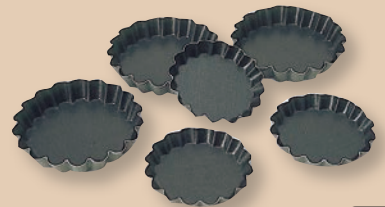

«Exopan» Törtchenform Tartelette ronde

Art-Nr./No d'article	Grösse/grandeur	Preis/prix
8006.90780	Ø 8 cm x H 1,2 cm	25 pcs. 81.15 (3.25 p.pc)
8006.90781	Ø 10 cm x H 1,8 cm	12 pcs. 55.25 (4.61 p.pc)



**Springform
Moule à charnières**

aus 0,38 mm starkem Stahl, PTFE antihafbeschichtet
En acier 0.38 mm, revêtement antiadhésif PTFE

Art-Nr./No d'article	Grösse/grandeur	Preis/prix
8006.94032	Ø 22,5 x H 6,5 cm	25.85
8006.94033	Ø 24,5 x H 6,5 cm	26.10
8006.94034	Ø 26,5 x H 6,5 cm	28.20



**«Exoglass®»
Kuchenform
Moule à cake**

auf beiden Seiten um 5 mm weiter werdend
Evasement 5 mm par côté

Art-Nr./No d'article	Grösse/grandeur	Preis/prix
8006.95701	14 x 8 cm x H 8 cm	39.95
8006.95702	18 x 8 cm x H 8 cm	45.85
8006.95703	20 x 8 cm x H 8 cm	46.90
8006.95704	25 x 8 cm x H 8 cm	55.25
8006.95705	30 x 8 cm x H 8 cm	57.60



**«Exoglass®»
Einzelform rechteckig, 6er Set
Cake rectangulaire, set à 6**

auf beiden Seiten um 5 mm weiter werdend
Evasement 5 mm par côté

Art-Nr./No d'article	Grösse/grandeur	Preis/prix
8006.95706	9 x 4 cm x H 4 cm	57.60/Set (9.60 p.pc)

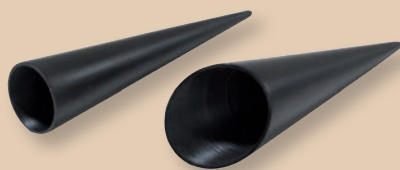

**«Exoglass®»
Hörnchen, 12er Set
Cornets, set à 12**

formbeständig, antihafbeschichtet
revêtement anti-adhésif

Art-Nr./No d'article	Grösse/grandeur	Preis/prix
8006.90782	Ø 3,5 cm x H 14 cm	86.90/Set (7.24 p.pc)



**«Exopan»
Backblech rund
Plaque à gâteau ronde**

gerillter Rand, Exopan antihafbeschichtet,
fester Boden
bord cannelé, revêtement Exopan, anti-adhésif,
fond fixe

Art-Nr./No d'article	Grösse/grandeur	Preis/prix
8006.90632	Ø 16 cm x H 2,0 cm	11.70
8006.90633	Ø 18 cm x H 2,5 cm	13.25
8006.90634	Ø 20 cm x H 2,5 cm	13.95
8006.90635	Ø 22 cm x H 2,5 cm	16.40
8006.90636	Ø 24 cm x H 2,5 cm	17.15
8006.90637	Ø 26 cm x H 2,5 cm	17.40
8006.90638	Ø 28 cm x H 2,5 cm	18.80
8006.90639	Ø 30 cm x H 2,5 cm	24.90
8006.90640	Ø 32 cm x H 2,5 cm	28.90



**«Exopan»
Geriffelte Kuchen- und Pastetenform
Plaque à gâteau ronde**

geriffelt, mit herausnehmbarem Boden, der
Kuchen lässt sich mühelos aus der Form nehmen
Fond mobile exopan, facilite le démoulage

Art-Nr./No d'article	Grösse/grandeur	Preis/prix
8006.95715	Ø 20 x H 2,5 cm	16.40
8006.95716	Ø 24 x H 2,5 cm	21.15
8006.95717	Ø 28 x H 2,5 cm	29.60

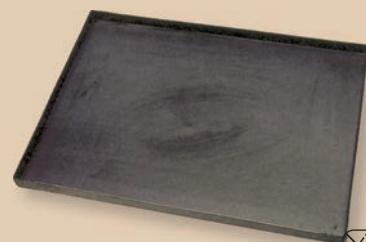

**Backblech
Plaque à pâtisserie**

aus gebläutem Stahl, gerader Rand
en tôle bleuie, bord droit

Art-Nr./No d'article	Grösse/grandeur	Preis/prix
8006.90666	60 x 40 cm x H 2 cm	66.95



**Backblech
Plaque à pâtisserie**

aus gebläutem Stahl
en tôle bleuie

Art-Nr./No d'article	Grösse/grandeur	Preis/prix
8006.90667	GN 1/1 - H 9 mm	38.80
8006.90668	GN 2/1 - H 9 mm	66.95



**Backblech
Plaque à pâtisserie**

aus Aluminium
en aluminium

Art-Nr./No d'article	Grösse/grandeur	Preis/prix
8270.80000	60 x 40 cm	28.20

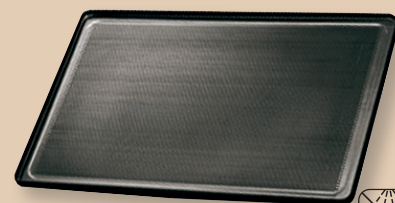

**Backblech gelocht
Plaque à pâtisserie perforée**

aus Aluminium, teflonbeschichtet
en aluminium, revêtement teflon

Art-Nr./No d'article	Grösse/grandeur	Preis/prix
8270.80001	60 x 40 cm	81.15

KONDITORENUTENSILIEN / USTENSILES DE PÂTISSERIES

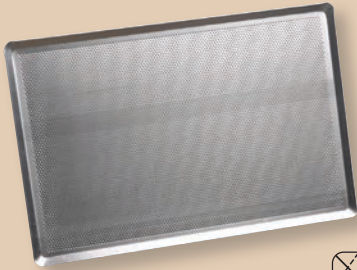
Backblech gelocht
Plaque à pâtisserie perforée

 aus Aluminium
 en aluminium

Art-Nr./No d'article	Grösse/grandeur	Preis/prix
8006.90783	GN 1/1 - 53 x 32,5 cm	44.65
8270.80002	GN 2/3 - 35,4 x 32,5 cm	34.05
8006.90784	60 x 40 cm	51.70

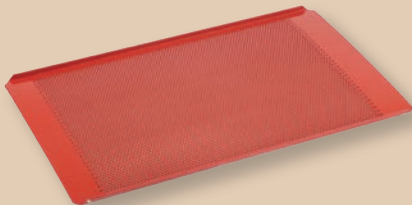
Backblech gelocht
Plaque à pâtisserie perforée

 gelocht Ø 3 mm, Materialstärke 1,5 mm, Silikon beschichtet, Temperaturbeständig bis 240°C
 perforée Ø 3 mm, épaisseur de matière 1,5 mm, revêtement silicone, résistant jusqu'à 240°C

Art-Nr./No d'article	Grösse/grandeur	Preis/prix
8582.88285	GN 1/1 - 53 x 32,5 cm	46.80
8270.80003	GN 2/3 - 35,4 x 32,5 cm	44.45
8270.80004	60 x 40 cm	46.80

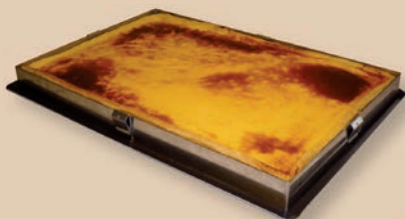
Erweiterbarer Rahmen
Cadre extensible

 4-teiliger Rahmen aus Inox
 Cadre composé de 4 pièces en inox

Art-Nr./No d'article	Grösse/grandeur	Preis/prix
8006.90786	30 x 20 cm – 56 x 36 cm	148.20
8006.90787	20 x 15 cm – 36 x 27 cm	114.65

Backmatte
Toile de cuisson

 Robuste Fiberglas-Silikon-Folie, Temperaturbeständig von -40°C bis +300°C
 Tricot de verre imprégné de silicone, résistant de -40°C à +300°C

Art-Nr./No d'article	Grösse/grandeur	Preis/prix
8006.90698	GN 1/1 - 53 x 32,5 cm	33.50
8006.90699	60 x 40 cm	42.30

«Ecopap»
Backpapier
Papier silicone

Ungebleichtes Backpapier, beidseitig beschichtet mit Silikon, 7-8 mal wiederverwendbar. 100% Biologisch abbaubar.

Papier kraft brun non blanchi, siliconé 2 faces, anti-adhérent et utilisable 7 à 8 fois. 100% biodégradable.

Art-Nr./No d'article	Grösse/grandeur	Preis/prix
8006.96213	60 x 40 cm 500 Stk./pcs.	61.15
8006.96214	53 x 32 cm 500 Stk./pcs.	44.65

Backkugeln
Noyaux de cuisson

 Keramik, lebensmittelecht, zum Blindbacken
 Céramique, garantis alimentaire, pour la cuisson à blanc

Art-Nr./No d'article	Grösse/grandeur	Preis/prix
8006.90785	500 gr	30.55

Gasbrenner/Karamellisierer
Brûleur à gaz/caraméliseur

Stabile Metallkonstruktion mit rutschfestem Kolben für Einhandbedienung, Sicherheitsschalter, kann mit handelsüblichem Universalgas nachgefüllt werden.

Solide construction en métal avec poignées anti-glisse pour un service à une main, interrupteur de sécurité,

Peut être rempli avec n'importe quel récipient en verre vendu dans le commerce

Art-Nr./No d'article	Grösse/grandeur	Preis/prix
8006.42324	Ø 3 cm x H 15 cm	58.80

Zubehör/Accessoires

8005.31402	Kisag Nachfüllgas Gaz Kisag 400 ml	6.55
-------------------	--	-------------

Flambierbrenner
Chalumeau de cuisine

 Edelstahl/Aluminium/Kunststoff (PP), stufenlos verstellbare Flamme, standsicher, nachfüllbar mit herkömmlichem Feuerzeuggas, mit Sicherung
 Acier inoxydable/aluminium/plastique (PP), flamme à réglage progressif, stable, rechargeable avec gaz à briquet classique, sécurité intégrée

Art-Nr./No d'article	Grösse/grandeur	Preis/prix
8102.15338	H 18 cm	43.50

Backhandschuh, 1 Paar
Gants de cuisson, 1 pair

 Fäustlinge ganz aus Baumwolle, dopplete Schlinge (Frottee), Stulpe Canvas
 Moufles en coton, boucle double (frotté), manche Canvas

Art-Nr./No d'article	Grösse/grandeur	Preis/prix
8006.94035	30 x 15 cm	13.95
8006.94036	38 x 17 cm	15.25



**Topflappen, 1 Paar
Manique, 1 pair**

Ganz aus Baumwolle, doppelte Schlinge (Frottee), Rückseite mit Gummibandschleife, waschbar bei +60°C, schwere Qualität
En coton, boucle double (frotté), l'envers avec boucle en élastique, lavable à +60°C, qualité lourde

Art-Nr./No d'article	Grösse/grandeur	Preis/prix
8006.94037	30 x 24 cm	13.25



**Darioleform Aluminium
Moule Dariole Alu**



Art-Nr./No d'article	Grösse/grandeur	Preis/prix
8006.43240	Ø 3 x H 3,5 cm	3.75
8006.43241	Ø 4 x H 4,5 cm	3.75
8006.43242	Ø 5 x H 5,5 cm	4.65
8006.43243	Ø 6 x H 6,0 cm	4.90
8006.43244	Ø 7 x H 7,0 cm	5.40
8006.43245	Ø 8 x H 8,0 cm	6.10



**«Exoglass®»
Darioleform, 6er Set
Moule Dariole, set à 6**

Art-Nr./No d'article	Grösse/grandeur	Preis/prix
8006.95707	Ø 4,5 x H 4,5 cm	67.65/Set (11.28 p.pc)
8006.95708	Ø 5,0 x H 5,0 cm	70.55/Set (11.76 p.pc)
8006.95709	Ø 5,5 x H 5,5 cm	73.85/Set (12.31 p.pc)
8006.95710	Ø 6,0 x H 6,0 cm	81.15/Set (13.53 p.pc)
8006.95711	Ø 7,0 x H 7,0 cm	91.60/Set (15.25 p.pc)



**Darioleform Edelstahl, 6er Set
Moule Dariole Inox, set à 6**

Art-Nr./No d'article	Grösse/grandeur	Preis/prix
8006.95712	Ø 4,5 x H 4,3 cm	55.25/Set (9.21 p.pc)
8006.95713	Ø 5,5 x H 5,3 cm	57.60/Set (9.60 p.pc)
8006.95714	Ø 6,5 x H 6,3 cm	62.30/Set (10.39 p.pc)



**Dessertringe mit Drücker
Moules à desserts avec poussoirs**

6-teiliges Set bestehend aus zwei Dessertringen Ø 47 mm und zwei Dessertringen Ø 73 mm sowie jeweils einem passendem Drücker.

Le set d'anneaux à desserts comprend 6 pièces: deux cercles de Ø 47 mm et deux cercles de Ø 73 mm avec un poussoir pour chaque dimension.

Art-Nr./No d'article	Grösse/grandeur	Preis/prix
8102.14156	Ø 47+73 mm x H 6 cm	27.75



**Mousse-Ring
Cercle à mousse**

aus Inox
en inox

Art-Nr./No d'article	Grösse/grandeur	Preis/prix
8006.90854	Ø 8 cm x H 4,5 cm	Set à 4 45.85 (11.46 p.pc)
8006.90855	Ø 12 cm x H 4,5 cm	15.25
8006.90856	Ø 16 cm x H 4,5 cm	19.15
8006.90857	Ø 24 cm x H 4,5 cm	24.90
8006.90858	Ø 28 cm x H 4,5 cm	34.65



**PVC-Konditorband
Ruban pâtissier PVC**

150 Mikrometer, sehr transparent und glänzend, formbeständig, für Mousses, Süsspreisen und Charlotten, mit Doppelklebeband
Épaisseur 150 microns, très transparent et brillant, grande rigidité, pour mousses, entremets et charlottes, livré avec un adhésif double face

Art-Nr./No d'article	Grösse/grandeur	Preis/prix
8006.90859	45 mm x 250 m	85.75
8006.90860	60 mm x 250 m	98.70

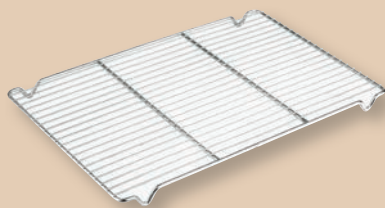

KONDITIONENUTENSILIEN / USTENSILES DE PÂTISSERIES

Kuchengitter
Grille plate

Art-Nr./No d'article	Grösse/grandeur	Preis/prix
8582.88033	47 x 31 cm x H 2,2 cm	44.65
8582.88034	59 x 39 cm x H 2,6 cm	56.40

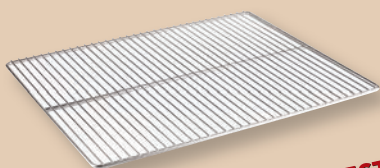
GN-Roste
Grilles GN
BEST PRICE

Art-Nr./No d'article	Grösse/grandeur	Preis/prix
8582.81199	GN 2/1 - 65,0 x 53,0 cm	66.95
8582.81198	GN 1/1 - 53,0 x 32,5 cm	31.70
8582.81296	GN 1/2 - 32,5 x 26,5 cm	17.60
8582.81796	GN 2/3 - 32,5 x 35,4 cm	22.30

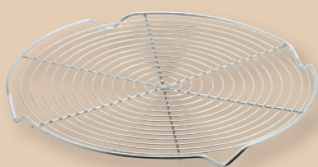
Kuchengitter
Grille à gâteau

Art-Nr./No d'article	Grösse/grandeur	Preis/prix
8102.11032	Ø 32 cm	29.35
8102.11036	Ø 36 cm	35.15

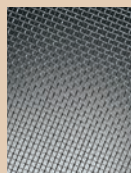

Mehlbürste
Brosse à farine
 schwarze Borsten
 soies noires

Art-Nr./No d'article	Grösse/grandeur	Preis/prix
8006.90100	L 21 cm	27.75

Mehlsieb
Tamis à farine

 Inox 18/10, 20 Löcher pro 2,5 cm²
 Inox 18/10, 20 trous par 2,5 cm²

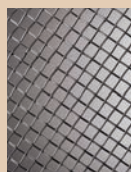
Art-Nr./No d'article	Grösse/grandeur	Preis/prix
8006.50226	Ø 22 cm x H 9 cm	55.25
8006.50208	Ø 30 cm x H 10 cm	79.85
8006.50209	Ø 35 cm x H 11 cm	94.50

Pâtisserie-Sieb
Tamis à pâtissier

 Inox 18/10, 10 Löcher pro 2,5 cm²
 Inox 18/10, 10 trous par 2,5 cm²

Art-Nr./No d'article	Grösse/grandeur	Preis/prix
8006.50227	Ø 30 cm x H 10 cm	76.20
8006.50228	Ø 35 cm x H 11 cm	88.10

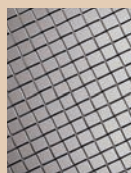
Brotsieb
Tamis à pain

 Inox 18/10, 8 Löcher pro 2,5 cm²
 Inox 18/10, 8 trous par 2,5 cm²

Art-Nr./No d'article	Grösse/grandeur	Preis/prix
8006.50225	Ø 22 cm x H 9 cm	54.05
8006.50206	Ø 30 cm x H 10 cm	78.55
8006.50207	Ø 35 cm x H 11 cm	92.80

Sieb
Tamis

 Inox 18/10, 4 Löcher pro 2,5 cm²
 Inox 18/10, 4 trous par 2,5 cm²

Art-Nr./No d'article	Grösse/grandeur	Preis/prix
8006.50210	Ø 30 cm x H 10 cm	74.95
8006.50211	Ø 35 cm x H 11 cm	98.70

Vorrats-/Streudosen
Bôte à réserve/Saupoudreuses
 Ø 7 cm x H 10 cm

Art-Nr./No d'article	Ausführung/version	Preis/prix
8102.14901	Netzstreuer Saupoudreuse	17.95
8102.14902	Salz-/Zuckerstreuer Saupoudreuse à sel/sucre	17.95
8102.14903	Gewürzstreuer Saupoudreuse à épices	17.95
8102.14904	Käsestreuer Saupoudreuse à fromage	17.95

Spritzflasche
Flacon-décor

 Biegsame Flasche aus Polyethylen mit Verschlusskappe
 Flacon souple en polyéthylène avec capuchon

Art-Nr./No d'article	Grösse/grandeur	Preis/prix
8006.90861	25 cl / Ø 6 cm x H 19,5 cm	11.70

Quetschflasche mini, 4er Set
Bouteille verseuse souple, set à 4
 Mit Schraubdeckel und Verschlusskappe
 Bouchon à vis de étanche, avec bouchon

Art-Nr./No d'article	Grösse/grandeur	Preis/prix
8582.93225	3 cl / Ø 3,0 x H 8,5 cm	8.20/Set (2.05 p.pc)
8582.93226	5 cl / Ø 3,5 x H 9,5 cm	9.40/Set (2.35 p.pc)



**Dressiersack
Poche à dresser**

extra geschmeidig, nylongeschweisst
extra-souple, en nylon soudé

Art.-Nr./No d'article	Länge/longueur	Preis/prix
8006.90676	25 cm	11.25
8006.90677	30 cm	11.70
8006.90678	35 cm	13.95
8006.90679	40 cm	16.40
8006.90680	45 cm	18.80
8006.90681	50 cm	23.50
8006.90682	60 cm	29.60



**Wegwerf-Dressiersack, 100er Set
Poches jetables, set à 100**

aus transparentem Polyethylen, Dicke 85 µm
en polyéthylène transparent, épaisseur de 85 micros

Art.-Nr./No d'article	Größe/grandeur	Preis/prix
8006.90683	54 x 30 cm	41.15/Set



**Dressiersack
Poche à dresser**

aus Kunststoffgewebe, verklebt, undurchlässig,
mit einstellbarer enger Spritze
Poche en tissu plastifié, collé, imperméable,
embout étroit, ajustable

Art.-Nr./No d'article	Länge/longueur	Preis/prix
8006.90371	31 cm	13.95
8006.90372	34 cm	14.55
8006.90373	40 cm	17.95
8006.90374	46 cm	21.15
8006.90375	50 cm	21.85
8006.90376	60 cm	28.90
8006.90377	70 cm	35.15



**Dressiersack-Halter
Support poche**

Aus Polypropylen, praktisch um den Dressiersack
während der Arbeit abzustellen und zu füllen,
verhindert, dass die Tüllen beschmutzt werden,
Sockel mit 8 Tüllenablagen

En polypropylène, très pratique pour poser la
poche pendant le travail et pour la remplir, évite de
souiller la douille, socle avec 8 trous pour range-
ment des douilles

Art.-Nr./No d'article	Größe/grandeur	Preis/prix
8006.90684	Ø 19,5 cm x H23 cm	27.75



**Sterntülle
Douille cannelée**

Inox 18/10
Inox 18/10

Art.-Nr./No d'article	Größe/grandeur	Preis/prix
8006.91201	Ø 4 mm	3.75
8006.91202	Ø 6 mm	3.75
8006.91203	Ø 7 mm	3.75
8006.91204	Ø 8 mm	3.75
8006.91205	Ø 9 mm	3.75
8006.91206	Ø 10 mm	3.75
8006.91207	Ø 11 mm	3.75
8006.91208	Ø 12 mm	3.75
8006.91209	Ø 14 mm	3.75



**Lochtülle
Douilles unie**

Inox 18/10
Inox 18/10

Art.-Nr./No d'article	Größe/grandeur	Preis/prix
8006.91301	Ø 4 mm	3.75
8006.91302	Ø 6 mm	3.75
8006.91303	Ø 7 mm	3.75
8006.91304	Ø 8 mm	3.75
8006.91305	Ø 10 mm	3.75
8006.91306	Ø 11 mm	3.75
8006.91307	Ø 12 mm	3.75
8006.91308	Ø 13 mm	3.75
8006.91309	Ø 14 mm	3.75



**Sterntüllen-Satz, 12er Set
Set de douilles cannelées, set à 12**

Inox 18/10, Schachtel à 12 Stk.
Inox 18/10, boîte de 12 pièces

Art.-Nr./No d'article	Preis/prix
8006.90688	79.85/Set (6.65 p.pc)



**Lochtüllen-Satz, 12er Set
Set de douilles unies, set à 12**

Inox 18/10, 4-15 mm Schachtel à 12 Stk.
Inox 18/10, Ø 4 à 15 mm, boîte de 12 douilles

Art.-Nr./No d'article	Preis/prix
8006.90687	74.95/Set (6.25 p.pc)



**Sterntüllen-Satz, 6er Set
Set de douilles cannelées, set à 6**

Polypropylen, 6 Stück, Ø 3/5/7/9/11/13 mm,
temperaturresistent bis +120° C, bruchfest,
sterilisierbar
Polypropylène, 6 pièces, Ø 3/5/7/9/11/13 mm,
Résistance à la température jusqu'à +120 °C,
résistance à la casse, stérilisable

Art.-Nr./No d'article	Preis/prix
8006.91150	10.55/Set (1.76 p.pc)



**Lochtüllen-Satz, 6er Set
Set de douilles unies, set à 6**

Polypropylen, 6 Stück, Ø 3/5/7/9/11/13 mm,
temperaturresistent bis +120° C, bruchfest,
sterilisierbar
Polypropylène, 6 pièces, Ø 3/5/7/9/11/13 mm,
Résistance à la température jusqu'à +120 °C,
résistance à la casse, stérilisable

Art.-Nr./No d'article	Preis/prix
8006.91160	10.55/Set (1.76 p.pc)

KONDITIONENUTENSILIEN / USTENSILES DE PÂTISSERIES

Passierbeutel-Vorsätze
Douilles interchangeables

Aus Polycarbonat, lebensmittelgerecht, verwendbar für alle Dressiersäcke, Schachtel mit 10 Tüllen für verschiedene Zwecke
 En polycarbonate agréé au contact alimentaire, adaptable sur tous types de poches, boîte composée de 10 douilles pour divers usages

Art-Nr./No d'article	Grösse/grandeur	Preis/prix
8006.90686	10-teilig	98.70/Set (9.87 p.pc)

Spritztülle für Gläser
Douille à verrines

vereinfacht diese lange und praktische Spritztülle die Befüllung der Verrine-Gläser, ohne die Glaswände zu beschmieren
 cette douille à embout long facilite le remplissage pratique des verrines sans en salir les parois

Art-Nr./No d'article	Länge/longueur	Grösse/grandeur	Preis/prix
8006.90797	10,5 cm	Ø 1 cm	29.35

Vermicelli-Spritztüllen, 2er Set
Douille vermicelli, set à 2

Ermöglicht in einem Handgriff das Spritzen von 4 Streifen mit je 2 mm Durchmesser
 Permet de déposer 4 filets de 2 mm d'un seul geste

Art-Nr./No d'article	Preis/prix
8006.90798	25.40/Set (12.20 p.pc)

Bandtüllen, 2er Set
Douille ruban, set à 2

Dicke: 1,5 mm und 5,5 mm
 Ep. 1,5 mm et 5,5 mm

Art-Nr./No d'article	Länge/longueur	Preis/prix
8006.90799	3 cm	25.40/Set (12.20 p.pc)

Automatischer Mini-Trichter
Entonnoir automatique mini

Inox. Dieser Trichter ist ideal zum Füllen kleiner Förmchen, Anrichten von Saucen, Dekorieren von Gebäck.

Inox. Cet entonnoir est idéal pour le remplissage de mini-moules, le dressage d'assiette avec coulis ou sauce, la décoration de pâtisseries.

Art-Nr./No d'article	Grösse/grandeur	Preis/prix
8006.96820	1 L / Ø 13,3 x H 28 cm	69.90

Gewerbe-Ausroller
Rouleau à pâte professionnel

Buche mit Kugellager
 Hêtre, roulement à bille

Art-Nr./No d'article	Grösse/grandeur	Preis/prix
8006.60136	30 x 8 cm	90.45
8006.60137	35 x 8 cm	98.70
8006.60138	40 x 8 cm	105.70
8006.60139	45 x 8 cm	111.25

Teigroller
Rouleau à pâte

aus Aluminium, mit gelagerten Griffen
 en aluminium, avec poignées tournantes sur roulements

Art-Nr./No d'article	Grösse/grandeur	Preis/prix
8006.90695	Ø 9 cm x 38 cm	178.80

Teigroller
Rouleau à pâte

aus Polyethylen
 en polyethylene

Art-Nr./No d'article	Grösse/grandeur	Preis/prix
8006.96216	Ø 4,8 cm x 50 cm	64.65

Lineal
Règle graduée
 aus Kunststoff
 Plastique

Art-Nr./No d'article	Grösse/grandeur	Preis/prix
8006.90796	64 cm	16.40

Spachtel
Racloir

aus Polyon, Patent Matfer
 en polyon, breveté Matfer

Art-Nr./No d'article	Grösse/grandeur	Preis/prix
8006.90697	12 x 9,5 cm	8.80

Spachtel
Racloir

aus Kunststoff
 en plastique

Art-Nr./No d'article	Grösse/grandeur	Preis/prix
8006.90250	1 - 11,3 cm x 7,5 cm	2.10
8006.90251	2 - 12,0 cm x 8,6 cm	3.25
8006.90252	3 - 14,8 cm x 9,9 cm	3.50

Schaber-Set 5-tlg.
Jeu de 5 racloirs

bestehend aus 4 Teigschabern und 1 Zierkamm
 comprenant de 4 cornes à pâte et 1 peigne à decor

Art-Nr./No d'article	Grösse/grandeur	Preis/prix
8006.90824	11 cm	13.95/Set (2.79 p.pc)



Teigschaber Silikon
Racloir siliconisé

Art-Nr./No d'article	Schaber/racloir	Stiel/manche	Preis/prix
8102.10610	8,2 x 4,8 cm	14 cm	9.85
8102.10611	8,8 x 5,7 cm	20 cm	10.60



Backpinsel
Pinceau à pâtissier

helle Borsten
Soies blanches

Art-Nr./No d'article	Grösse/grandeur	Preis/prix
8006.90500	10 x 4,5 mm	3.85
8006.90501	15 x 5 mm	3.85
8006.90502	20 x 5 mm	3.85
8006.90503	25 x 5 mm	3.85
8006.90504	30 x 6 mm	5.15
8006.90508	35 x 6 mm	5.15
8006.90505	40 x 6 mm	5.15
8006.90506	50 x 7 mm	7.95
8006.90507	60 x 7 mm	9.35
8006.90509	80 x 7 mm	14.30



Bäckerpinsel
Pinceau de pâtissier

Griff synthetisch, Bürste Polyamid
Manche synthétique, fibres polyamide

Art-Nr./No d'article	Breite/largeur	Preis/prix
8006.90689	3 cm	9.85
8006.90690	4 cm	11.25
8006.90691	5 cm	13.50
8006.90692	6 cm	16.80
8006.90693	7 cm	19.95



Back-/Grillpinsel
Pinceau à pâtisserie/grillade

Edelstahl/Silikon, Griffstärke 3,4 mm
Inox/silicone, l'épaisseur de la poignée 3,4 mm

Art-Nr./No d'article	Grösse/grandeur	Preis/prix
8102.10653	2,2 x 6,0 cm, L 24,8 cm	7.25
8102.10673	4,3 x 6,8 cm, L 25,5 cm	8.90
8102.10657	2,2 x 6,0 cm, L 24,8 cm	7.25
8102.10667	4,0 x 6,0 cm, L 25,0 cm	7.50
8102.10677	4,3 x 6,8 cm, L 25,5 cm	8.90



Back-/Grillpinsel XL
Pinceau à pâtisserie/grillade XL

Edelstahl/Silikon, Griffstärke 4 mm
Inox/silicone, l'épaisseur de la poignée 4 mm

Art-Nr./No d'article	Grösse/grandeur	Preis/prix
8102.10697	6,5 x 9,2 cm, L 32,5 cm	13.25



Messerabstreichbehälter
Support de racloir de couteau

aus Edelstahl 18/10, hochglänzend poliert, schwere Qualität, Bodeneinlage aus POM zum schonen der Messerspitzen, Abstreichbacken aus Gummi (Hitzebeständig bis +80°C)

En Inox 18/10, poli brillant, qualité lourde, dépôt de fond en POM pour ménagé les pointes des couteaux

Art-Nr./No d'article	Grösse/grandeur	Inhalt/capacité	Preis/prix
8006.94030	Ø 11 x H 20 cm	1,5 L	96.20
8006.94031	Ø 11 x H 30 cm	2,3 L	114.65



Teigrädchen
Roulette à pâte

glattes Rädchen aus matt poliertem Klingenstahl, mit Fingerschutz
Roue unie en acier poli mat, avec protection pour doigts

Art-Nr./No d'article	Grösse/grandeur	Länge/largeur	Preis/prix
8006.94009	Ø 5,7 cm	18,5 cm	6.95



Teigrädchen
Roulette à pâte

gewelltes Rädchen aus matt poliertem Klingenstahl, mit Fingerschutz
Roue annelé en acier poli mat, avec protection pour doigts

Art-Nr./No d'article	Grösse/grandeur	Länge/largeur	Preis/prix
8006.94029	Ø 5,7 cm	18,5 cm	7.50

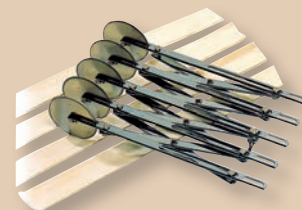

Teigeinteiler
Rouleau extensible Multicoupe

Chromstahl, für Breiten 10-120 mm
en acier chromé, pour largeur de 10 à 120 mm

Art-Nr./No d'article	Grösse/grandeur	Preis/prix
8006.90261	5 Rollen/5 roulettes Ø 55mm	125.00

KONDITIONENUTENSILIEN / USTENSILES DE PÂTISSERIES



Rauten-Rolle
Rouleau à losanges
aus Kunststoff
en plastique

Art-Nr./No d'article Grösse/grandeur Preis/prix
8006.90794 Ø 4,5 cm x 10 cm **19.15**



Stech-Rolle
Rouleau pic-vite
aus Kunststoff
en plastique

Art-Nr./No d'article Grösse/grandeur Preis/prix
8006.90795 Ø 6,5 cm x 11 cm **21.15**



Kuchenteil-Markierer
Diviseur à gâteaux

aus Kunststoff, markiert Kuchen in gleich grosse Stücke
en plastique, pour le marquage des gâteaux afin d'effectuer un découpage en parts régulières

Art-Nr./No d'article	anz. Stücke/parts	Ø	Preis/prix
8006.70122	10	Ø 26.5 cm	15.25
8006.70123	14	Ø 26.5 cm	15.95
8006.70124	12/18	Ø 27 cm	17.15



Koffer mit 10 Tauchgabeln
Boîte de 10 broches à tremper

4 runde Tauchgabeln Ø 14, 16, 18 und 20 mm,
1 ovale Tauchgabel, 1 birnenförmige Gabel, 1
Tauchspirale, 3 Gabeln mit 2, 3 und 4 Zacken
4 broches rondes Ø 14, 16, 18 und 20 mm, 1
broche ovale, 1 broche poire, 1 broche spirale, 3
fourchettes 2, 3 et 4 dents

Art-Nr./No d'article Preis/prix
8006.90820 **254.05**



Koffer mit 5 Tauchgabeln
Boîte de 5 broches à tremper

1 runde Tauchgabel Ø 16 mm, 1 Tauchspirale,
3 Gabeln mit 2, 3 und 4 Zacken
1 broche ronde Ø 16 mm, 1 broche spirale, 3
fourchettes 2, 3 et 4 dents

Art-Nr./No d'article Preis/prix
8006.90821 **178.80**

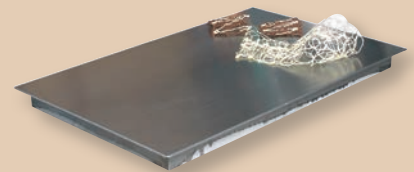

«Cool Décor»
Kühlplatte
Plaque à restitution de froid

Kühlplatte zur Herstellung von leicht formbaren
Schokoladen-Dekors
Plaque à restitution de froid pour la réalisation de
décor en chocolat facilement façonnables

Art-Nr./No d'article Grösse/grandeur Preis/prix
8006.90822 60 x 40 cm / 9,2 kg **388.20**



Schokoladen-Schaber
Racloir à chocolat

mit 3 verschiedenen Schabkanten, geeignet zum
Abschaben der Schokolade auf Cool-Décor-
Platten
avec 3 côtés différents pour racler le chocolat sur
la plaque Cool-Décor

Art-Nr./No d'article Grösse/grandeur Preis/prix
8006.90823 19 cm **13.50**



**Eisportionierer
Portionneur à glace**

Aluminium, PTFE-beschichtet, mit wärmeleitender Flüssigkeit im Griff, Länge 17,5 cm
Aluminium, recouvert PTFE, poignée avec liquide conducteur de chaleur, longueur 17,5 cm

Art-Nr./No d'article	Grösse/grandeur	Preis/prix
8006.91920	1/12 l - 6,0 x 5,0 cm	15.25
8006.91921	1/16 l - 6,0 x 4,5 cm	15.25
8006.91922	1/20 l - 5,0 x 4,0 cm	15.25
8006.91923	1/24 l - 5,0 x 3,5 cm	15.25

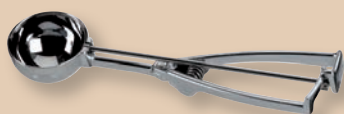

**STÖCKEL
Eisportionierer
Portionneur à glace**

Inox 18/10, mit Feder, schwere Qualität
Inox 18/10, avec ressort, forte qualité

Art-Nr./No d'article	Grösse/grandeur	Preis/prix
8006.95740	1/8 l - Ø 8,0 cm	73.85
8006.95741	1/10 l - Ø 7,0 cm	73.85
8006.95742	1/12 l - Ø 6,7 cm	73.85
8006.95743	1/16 l - Ø 5,9 cm	73.85
8006.95744	1/20 l - Ø 5,6 cm	73.85
8006.95745	1/24 l - Ø 5,1 cm	73.85
8006.95746	1/30 l - Ø 4,9 cm	73.85
8006.95747	1/36 l - Ø 4,7 cm	73.85
8006.95748	1/40 l - Ø 4,5 cm	73.85
8006.95749	1/50 l - Ø 4,0 cm	69.35
8006.95750	1/60 l - Ø 3,5 cm	69.35
8006.95751	1/70 l - Ø 3,0 cm	69.35
8006.95752	1/100 l - Ø 2,5 cm	69.35



**STÖCKEL
Ovaler Eisportionierer
Portionneur à glace ovale**

Inox 18/10, mit Feder, schwere Qualität
Inox 18/10, avec ressort, forte qualité

Art-Nr./No d'article	Grösse/grandeur	Preis/prix
8006.90889	1/30 l - Ø 6,2 x 4,3 cm	76.20
8006.90890	1/40 l - Ø 5,7 x 3,8 cm	76.20



**Ausstechersatz rund
Découpoirs ronds**
aus Weissblech, 14 Stück in der Dose
fer-blanc, en boîte de 14 pièces

glatt lisse		
Art-Nr./No d'article	Grösse/grandeur	Preis/prix
8006.90234	Ø 2,2 - 11,3 cm	28.90

gewellt cannelés		
Art-Nr./No d'article	Grösse/grandeur	Preis/prix
8006.90233	Ø 2 - 10,5 cm	31.70

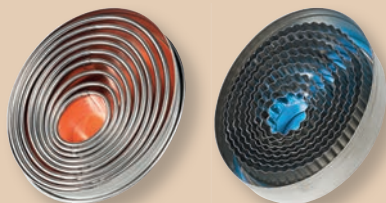

**Ausstechersatz oval
Découpoirs ovales**
aus Weissblech, 9 Stück in der Dose
fer-blanc, en boîte de 9 pièces

glatt lisse		
Art-Nr./No d'article	Grösse/grandeur	Preis/prix
8006.90236	2,5 x 2 - 8,5 x 7,2 cm	22.95

gewellt cannelés		
Art-Nr./No d'article	Grösse/grandeur	Preis/prix
8006.90235	2,5 x 2 - 8 x 6,5 cm	23.50

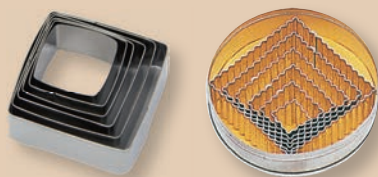

**Ausstechersatz «Quadrate»
Découpoirs «carrée»**
6 Stück in der Dose
en boîte de 6 pièces

glatt lisse		
Art-Nr./No d'article	Grösse/grandeur	Preis/prix
8006.81101	Ø 12 cm x H 3 cm	14.30

gewellt cannelés		
Art-Nr./No d'article	Grösse/grandeur	Preis/prix
8006.81102	Ø 12,5 cm x H 3,5 cm	16.10



**Ausstechersatz «Hexagon»
Découpoirs «hexagon»**
6 Stück in der Dose
en boîte de 6 pièces

glatt lisse		
Art-Nr./No d'article	Grösse/grandeur	Preis/prix
8006.81103	Ø 10 cm x H 3 cm	14.30

gewellt cannelés		
Art-Nr./No d'article	Grösse/grandeur	Preis/prix
8006.81104	Ø 10 cm x H 3,5 cm	16.40



**Ausstechersatz «Tropfen»
Découpoirs «goutteau»**
6 Stück in der Dose
en boîte de 6 pièces

glatt lisse		
Art-Nr./No d'article	Grösse/grandeur	Preis/prix
8006.81105	Ø 12 cm x H 3 cm	14.30

gewellt cannelés		
Art-Nr./No d'article	Grösse/grandeur	Preis/prix
8006.81106	Ø 12,5 cm x H 3,5 cm	16.40

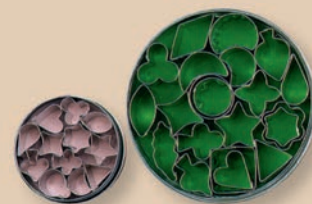

**Garnier-Ausstecher-Set
Jeu de découpoirs**
aus Weissblech, komplett in der Dose
fer-blanc, complet en boîte

Art-Nr./No d'article	Grösse/grandeur	Ø	Preis/prix
8006.90231	12 Stk/pce	1,6 - 2,2 cm	15.25
8006.90232	21 Stk/pce	2,5 - 4,0 cm	26.95

KONDITIONENUTENSILIEN / USTENSILES DE PÂTISSERIES



Ausstechersatz «Geometric»
Découpoirs «geometric»
42 Stück in der Dose
en boîte de 42 pièces

Art-Nr./No d'article Grösse/grandeur Preis/prix
8006.81100 Ø 6-22 mm **35.15**



Ausstechersatz «Herz»
Découpoirs «Cœur»
6 Stück in der Dose
en boîte de 6 pièces

Art-Nr./No d'article Grösse/grandeur Preis/prix
8006.81107 Ø 10 cm x H 3 cm **14.30**



Ausstechersatz «Stern»
Découpoirs «étoile»
6 Stück in der Dose
en boîte de 6 pièces

Art-Nr./No d'article Grösse/grandeur Preis/prix
8006.81108 Ø 10 cm x H 3 cm **14.30**



Ausstechersatz «Halbmond»
Découpoirs «demi-lune»
6 Stück in der Dose
en boîte de 6 pièces

Art-Nr./No d'article Grösse/grandeur Preis/prix
8006.81109 Ø 10 cm x H 3 cm **14.30**



Ausstechersatz «Schneeflocke»
Découpoirs «flocon de neige»
Polyamid, 7 Stück in der Dose
Polyamide, en boîte de 7 pièces

Art-Nr./No d'article Grösse/grandeur Preis/prix
8006.40550 Ø 40-130 mm x H 35 mm **35.15**

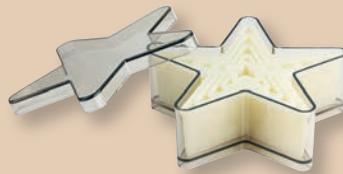

Ausstechersatz «Stern»
Découpoirs «étoile»
Polyamid, 7 Stück in der Dose
Polyamide, en boîte de 7 pièces

Art-Nr./No d'article Grösse/grandeur Preis/prix
8006.40551 Ø 22-120 mm x H 35 mm **35.15**



Ausstechersatz «Herz»
Découpoirs «Cœur»
Polyamid, 7 Stück in der Dose
Polyamide, en boîte de 7 pièces

Art-Nr./No d'article Grösse/grandeur Preis/prix
8006.40552 Ø 22-110 mm x H 35 mm **35.15**



Ausstechersatz «Tropfen»
Découpoirs «goutteau»
Polyamid, 8 Stück in der Dose
Polyamide, en boîte de 8 pièces

Art-Nr./No d'article Grösse/grandeur Preis/prix
8006.40553 Ø 15-90 mm x H 35 mm **35.15**



«Exoglass®»
Ausstechersatz rund
Découpoirs rondes

glatte Form, fäulnisfrei, spülmaschinenfest, sterilisierbar, dauerhaft scharfe Schnittkanten, dauerhaft formbeständig, 9 Stück in der Dose
Découpoirs lisses, imputrescible, adapté au passage au lave-vaisselle et à stérilisation, il garantit un tranchant des découpoirs de longue durée, conserve toujours sa forme d'origine, boîte de 9 pièces

Art-Nr./No d'article Grösse/grandeur Preis/prix
8006.90825 Ø 2-10 cm **76.20**



«Exoglass®»
Ausstechersatz rund
Découpoirs rondes

gewellte Form, fäulnisfrei, spülmaschinenfest, sterilisierbar, dauerhaft scharfe Schnittkanten, dauerhaft formbeständig, 9 Stück in der Dose
Découpoirs cannelés, imputrescible, adapté au passage au lave-vaisselle et à stérilisation, il garantit un tranchant des découpoirs de longue durée, conserve toujours sa forme d'origine, boîte de 9 pièces

Art-Nr./No d'article Grösse/grandeur Preis/prix
8006.90826 Ø 2-10 cm **105.70**

KONDITIONENUTENSILIEN / USTENSILES DE PÂTISSERIES

**Silikonbackformen GN 1/3 «Gastroflex»
Moules à pâtisserie GN 1/3 «Gastroflex»**

Produktvorteile

- Einfache Handhabung (GN1/3)
- Hitzebeständig von -50° bis 250°C
- Zum Backen auf Gitter aus Edelstahlbraht oder gelochtem Backblech
- Aus purem injiziertem lebensmittelechtem Silikon
- Starke mechanische Resistenz
- Keine Probleme mit Erschütterungen
- Spülmaschinengeeignet (90°C)

Avantages produit

- Facilité de manipulation (GN 1/3)
- Résistance de -50°C à +250°C
- Utiliser sur grille fil inox ou plaque à pâtisserie perforée
- En silicone alimentaire pur injecté
- Forte résistance mécanique
- Aucun problème de résistance aux chocs
- Résistance aux cycles de lavage à 90°C

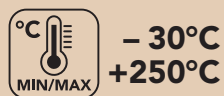

Halbkreise
Demi-sphères
8006.90830 Ø 40 mm x H 20 mm **17.60**



Halbkreise
Demi-sphères
8006.90831 Ø 70 mm x H 35 mm **17.60**



Hefeteilchen
Briochettes
8006.90832 Ø 79 mm x H 37 mm **17.60**

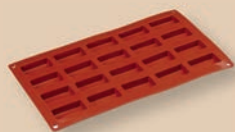

Financiers
Financier
8006.90833 49 x 26 mm x H 11 mm **17.60**

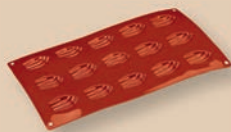

Mini-Madeleins
Mini-madeleines
8006.90846 65 x 32 mm x H 13 mm **17.60**



Savarins
Savarins
8006.90847 Ø 40 mm x H 12 mm **17.60**

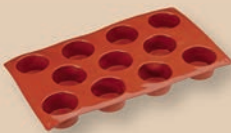

Mini-Muffins
Mini-muffins
8006.90836 Ø 50 mm x H 28 mm **17.60**

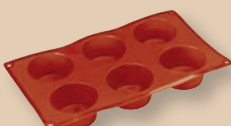

Muffins
Muffins
8006.90837 Ø 70 mm x H 37 mm **17.60**

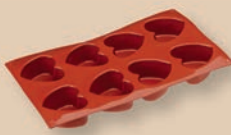

Herzen
Cœurs
8006.90848 65 x 60 mm x H 35 mm **17.60**

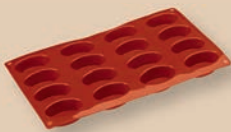

Petits-Fours oval
Petits-fours ovales
8006.90839 53 x 33 mm x H 33 mm **17.60**



Mini-Pyramiden
Mini-pyramides
8006.90840 36 x 36 mm x H 22 mm **17.60**



Pyramiden
Pyramides
8006.90841 71 x 71 mm x H 40 mm **17.60**

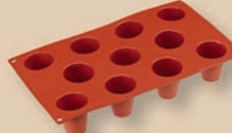

Cremetörtchen
Darioles rondes
8006.90842 Ø 45 mm x H 48 mm **17.60**

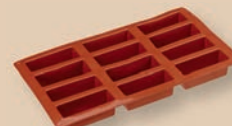

Mini-Kuchen
Mini-cakes
8006.90844 80 x 30 mm x H 30 mm **17.60**

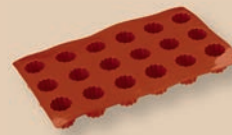

Mini-Puddingform
Mini canelés bordelais
8006.90845 Ø 35 mm x H 35 mm **17.60**

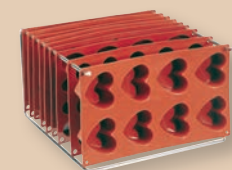

Ständer zu Silikonbackformen, Edelstahl 18/10
Support pour moules à pâtisserie, en inox 18/10
8006.90866 30 x 30 x H 17,5 cm **72.65**

PIZZA-PASTAUTENSILIEN / USTENSILES DE PIZZA-PASTA



Pizzablech Plaque à Pizza

aus gebläutem Stahl
en tôle bleue

Art-Nr./No d'article	Grösse/grandeur	Preis/prix
8006.90101	Ø 24 cm x H 2,5 cm	7.50
8006.90102	Ø 26 cm x H 2,5 cm	8.90
8006.90103	Ø 28 cm x H 2,5 cm	9.85
8006.90104	Ø 30 cm x H 2,5 cm	11.15
8006.90105	Ø 32 cm x H 2,5 cm	11.75
8006.90106	Ø 36 cm x H 2,5 cm	13.50
8006.90107	Ø 40 cm x H 2,5 cm	16.40



Pizzablech-Zange Pince à plaques à pizza

Inox 18/10
Inox 18/10

Art-Nr./No d'article	Grösse/grandeur	Preis/prix
8006.90108	22 x 1,8 cm	31.70



Pizzaschieber Pelle à enfourner

aus Aluminium, mit schwarzem Griff
en alu, avec manche noir

Art-Nr./No d'article	Grösse/grandeur	Länge/longueur	Preis/prix
8006.90800	33 x 33 cm	180 cm	176.20
8006.90801	36 x 36 cm	183 cm	188.20
8006.90802	40 x 40 cm	187 cm	249.35
8006.90803	45 x 45 cm	192 cm	272.90
8006.90804	50 x 50 cm	197 cm	319.95



Ofenschieber Palette à pizza

Inox, schwere Qualität
Inox, qualité lourde

Art-Nr./No d'article	Grösse/grandeur	Länge/longueur	Preis/prix
8006.90805	Ø 18 cm	180 cm	161.15
8006.90806	Ø 22 cm	184 cm	176.20



Ofenbürste mit Stiel Brosse de four avec manche

Holz/Edelstahl, naturborsten, robuste und langlebige Ausführung, schwere Qualität
Bois / acier inoxydable, poils naturels, robuste et durable, qualité lourde

Art-Nr./No d'article	Grösse/grandeur	Preis/prix
8006.90810	180 cm	198.95

Ersatzteile/Pièces de rechange

8006.90812	Ersatzbürste Brosse de rechange	43.50
------------	------------------------------------	-------

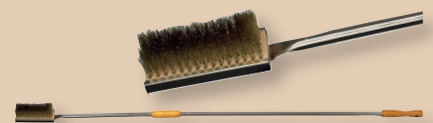

Ofenbürste mit Stiel Brosse de four avec manche

Holz/Edelstahl, messingborsten, robuste und langlebige Ausführung, schwere Qualität
Bois / acier inoxydable, poils en laiton, robuste et durable, qualité lourde

Art-Nr./No d'article	Länge/longueur	Preis/prix
8006.90811	180 cm	188.20

Ersatzteile/Pièces de rechange

8006.90813	Ersatzbürste Brosse de rechange	63.50
------------	------------------------------------	-------

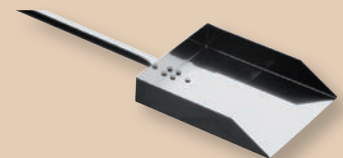

Kohlenschaufel Pelle à braise

Inox, schwere Qualität
Inox, qualité lourde

Art-Nr./No d'article	Länge/longueur	Preis/prix
8006.90807	180 cm	143.50



Ölkanne Arrosoir à huile

Inox 18/10
Inox 18/10

Art-Nr./No d'article	Grösse/grandeur	Preis/prix
8006.91850	0,5 l - H 15 cm	35.15
8006.91851	1,0 l - H 16,5 cm	44.65
8006.91852	2,0 l - H 21,5 cm	56.40



Pizzaballenbehälter

Récipient de pizza

aus weissem HD-Polyethylen, schwere Qualität
En polyéthylène-HD blanc, qualité lourde

Art-Nr./No d'article Grösse/grandeur Preis/prix
8006.94038 60 x 40 x H 7,5 cm **32.90**

Deckel separat

Couvercle séparément

Art-Nr./No d'article Grösse/grandeur Preis/prix
8006.94039 60 x 40 x H 2,5 cm **29.35**



Stapelbare Rechteckkörbe

Cagette empilable

Teigbehälter, durchbrochener Korb aus Polyethylen
Ou cuisse à pâtons cagette ajourée, en polyéthylène

Art-Nr./No d'article Grösse/grandeur Preis/prix
8006.95718 60 x 40 x H 10 cm **26.95**

Deckel separat

Couvercle séparément

Art-Nr./No d'article Grösse/grandeur Preis/prix
8006.95719 60 x 40 cm **23.50**



Stapelbare Rechteckkörbe

Cagette empilable

Teigbehälter, durchbrochener Korb aus Polyethylen
Ou cuisse à pâtons cagette ajourée, en polyéthylène

Art-Nr./No d'article Grösse/grandeur Preis/prix
8006.95720 40 x 30 x 10 cm **18.80**

Deckel separat

Couvercle séparément

Art-Nr./No d'article Grösse/grandeur Preis/prix
8006.95721 40 x 30 cm **17.40**



Holzrolle für Pappardelle

Rouleau en bois pour Pappardelle

Ergibt Pasta mit einer Breite von 13 mm
Pour pâtes avec une largeur de 13 mm

Art-Nr./No d'article Grösse/grandeur Preis/prix
8006.95100 Ø 4 cm x 32 cm **18.80**



Holzrolle für breite Tagliatelle

Rouleau en bois pour Tagliatelle larges

Ergibt Pasta mit einer Breite von 6 mm
Pour pâtes avec une largeur de 6 mm

Art-Nr./No d'article Grösse/grandeur Preis/prix
8006.95101 Ø 4 cm x 32 cm **18.80**



Holzrolle für Tagliatelle

Rouleau en bois pour Tagliatelle

Ergibt Pasta mit einer Breite von 4 mm
Pour pâtes avec une largeur de 4 mm

Art-Nr./No d'article Grösse/grandeur Preis/prix
8006.95102 Ø 4 cm x 32 cm **18.80**



Nudelroller

Roulette à pâtes

Ausgestattet mit 9 gezackten und herausnehmbaren Teigrollern, Abstand zwischen den Rollen 15 mm, für 6 oder 3 Rollen für 30-45 mm breite Teigplatte

Equipée de 9 roulettes cannelées amovibles, espacées de 15 mm, par 6 ou 3 pour les largeurs de bandes de 30 à 40 mm

Art-Nr./No d'article Preis/prix
8006.95722 **39.95**



Ravioliformen, 3er Set

Moules à raviolis, set à 3

Satz mit 3 Formen für die Zubereitung von Maultaschen, Ravioli, Mini-Calzone etc. Formen aus Polypropylen, spülmaschinenfest.

Set de 3 moules pour préparer les raviolis, les mini-calzones et autres pâtisseries. Moules en polypropylène, compatibles lave-vaisselle.

Art-Nr./No d'article Grösse/grandeur Preis/prix
8006.95103 Ø 9,5 / 12 / 15,5 cm **23.50**



Ravioliausstecher quadratisch

Découpeur de ravioli rectangulaire

mit seidenmatt poliertem Griff aus Edelstahl 18/10, Ausstecher aus hartverchromtem Zinkguss
avec manche poli mat en acier inoxydable 18/10, découpeur en fonte zinc chromé

Art-Nr./No d'article Grösse/grandeur Länge/longueur Preis/prix
8006.94040 6,5 x 6,5 cm 15,5 cm **9.85**



Ravioliausstecher rund

Découpeur de ravioli rond

mit seidenmatt poliertem Griff aus Edelstahl 18/10, Ausstecher aus hartverchromtem Zinkguss
avec manche poli mat en acier inoxydable 18/10, découpeur en fonte zinc chromé

Art-Nr./No d'article Grösse/grandeur Länge/longueur Preis/prix
8006.94041 Ø 6 cm 15,5 cm **9.85**

PIZZA-PASTAUTENSILIEN / USTENSILES DE PIZZA-PASTA

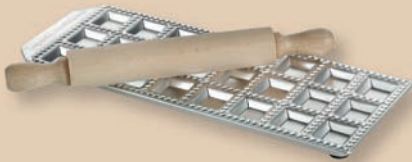
**IMPERIA «Raviolamp»****Ravioliform
Moule à ravioli**

Für 24 quadratische Ravioli 35 x 35 mm.
Ravioliform aus gepresstem Aluminium, Boden aus emailliertem Stahl, mit Gummifüssen, inklusive Teigrolle aus Holz.

Pour 24 raviolis carrés 35 x 35 mm.

En aluminium embouti monté sur une base en acier muni de pieds en caoutchouc assurant une adhérence parfaite, livré avec un rouleau bois.

Art-Nr./No d'article	Grösse/grandeur	Preis/prix
8006.95104	27 x 10,5 cm	51.70

**IMPERIA «Raviolamp»****Ravioliform
Moule à ravioli**

Für 36 quadratische Ravioli 35 x 35 mm.
Ravioliform aus gepresstem Aluminium, Boden aus emailliertem Stahl, mit Gummifüssen, inklusive Teigrolle aus Holz.

Pour 36 raviolis carrés 35 x 35 mm.

En aluminium embouti monté sur une base en acier muni de pieds en caoutchouc assurant une adhérence parfaite, livré avec un rouleau bois.

Art-Nr./No d'article	Grösse/grandeur	Preis/prix
8006.95105	30 x 14 cm	51.70

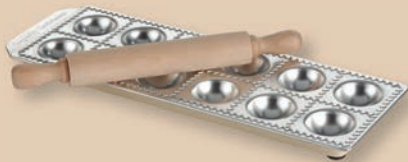
**IMPERIA «Raviolamp»****Ravioliform
Moule à ravioli**

Für 12 quadratische Ravioli 52 x 52 mm.
Ravioliform aus gepresstem Aluminium, Boden aus emailliertem Stahl, mit Gummifüssen, inklusive Teigrolle aus Holz.

Pour 12 raviolis carrés 52 x 52 mm.

En aluminium embouti monté sur une base en acier muni de pieds en caoutchouc assurant une adhérence parfaite, livré avec un rouleau bois.

Art-Nr./No d'article	Grösse/grandeur	Preis/prix
8006.95106	34 x 14 cm	51.70

**Teigrädchen
Roulette à pâte**

glattes Rädchen aus matt poliertem Klingenschliff, mit Fingerschutz
Roue unie en acier poli mat, avec protection pour doigts

Art-Nr./No d'article	Grösse/grandeur	Länge/largeur	Preis/prix
8006.94009	Ø 5,7 cm	18,5 cm	6.95

**Teigrädchen
Roulette à pâte**

gewelltes Rädchen aus matt poliertem Klingenschliff, mit Fingerschutz
Roue annelé en acier poli mat, avec protection pour doigts

Art-Nr./No d'article	Grösse/grandeur	Länge/largeur	Preis/prix
8006.94029	Ø 5,7 cm	18,5 cm	7.50

**TRIANGLE
Pizzaschneider
Roulette à pizza**

Edelstahl
Inox

Art-Nr./No d'article	Länge/largeur	Preis/prix
8006.42638	19 cm	19.50

**Pizzaschneider
Roulette à pizza**

Art-Nr./No d'article	Grösse/grandeur	Preis/prix
8102.17410	100 mm	11.70



Diverse Pastamaschinen finden Sie im Kapitel Apparate.

Vous trouvez les machines à pâte dans le chapitre «Appareils»

THERMOMETER / THERMOMÈTRES



**«TESTO 103»
Klapp-Thermometer
Thermomètre rabattable**

Länge 11 cm, klein, praktisch, handlich, Schutzklasse IP55, inkl. Batterien
Longueur 11 cm, pratique, classe protection IP55, incl. piles

Art-Nr./No d'article	Messbereich/portée de mesure	Preis/prix
8006.95030	-30 ... +220 °C	85.75



**«TESTO 104»
Klapp-Thermometer
Thermomètre rabattable**

wasserdicht, klappbar, Schutzklasse IP65, Auto-Hold, beleuchtetes Display, robustes Metall-Klappgelenk mit stabilem Messfühler, inkl. Batterien
étanche à l'eau, repliable, classe protection IP65, Auto-Hold, display illuminé, charnière robuste avec sonde solide, incl. piles

Art-Nr./No d'article	Messbereich/portée de mesure	Preis/prix
8006.95040	-30 ... +220 °C	138.60



**«TESTO»
Mini-Einstechthermometer
Mini-thermomètre rapide**

Zum schnellen Erfassen der Temperatur in der Luft, in Flüssigkeiten, in weichen oder pulverigen Stoffen, inkl. Schutzhülle für Sondenrohr. Knopfzelle 3 V, Betriebsdauer 150 h, Länge: 200 mm. Garantie 6 Monate
Pour rapidement prendre la température de l'air, dans les liquides et les poudres, compris tube protecteur, pile bouton 3 V, autonomie de la pile env. 150 h, longueur 200 mm, garantie 6 mois

Genauigkeit/Exactitude $\pm 2\%$ (+100 - +200°C)
 $\pm 3\%$ (+200 - +250°C) $\pm 1^\circ\text{C}$ (-50 - +100°C)

Art-Nr./No d'article	Messbereich/portée de mesure	Preis/prix
8006.95002	-50 - +250°C	61.15



**Digitaler Temperaturfühler
Thermomètre sonde électronique**

Thermoelement K, Edelstahlfühler L 110 mm mit Schutzhülle, Wasserdichtes Gehäuse IP65, Auflösung 1°C ab 200°C, °C/°F konvertierbar
Thermocouple K, sonde inox L 110 mm avec étui de protection, boîtier étanche IP65, Résolution 0,1°C / 1°C au delà de 200°C, convertible °C/°F

Genauigkeit / Exactitude $\pm 0,8^\circ\text{C}$

Art-Nr./No d'article	Länge/longueur	Preis/prix
8006.90850	21 cm	104.20



**«TESTO 104-IR»
Infrarot/Einstech-Thermometer
Thermomètre rabattable à infra-rouge**

Wie Testo104, aber zusätzlich mit Infrarot für berührungslose Messung.
Comme Testo 104, additionel avec infra-rouge pour mesure sans contact.

Art-Nr./No d'article	Messbereich/portée de mesure	Preis/prix
8006.95041	-50 ... +250 °C	195.25

THERMOMETER / THERMOMÈTRE

Infrarot-Thermometer + Fühler
Thermomètre infra-rouge + sonde

Extra HACCP, mit Alarmsignal bei nicht konformer Temperatur, Infrarotmessung für ein schneller Ergebnis und Messung per Fühler für ein genaues Ergebnis, Wasserdichtes Thermometer IP65, Auflösung 0,2°C, einklappbarer Edelstahlfühler, °C/°F konvertierbar

Spécial HACCP, avec alerte de T° mesurée non conforme, mesure par infrarouge pour relevé rapide ou par sonde pour la précision, thermomètre étanche IP65, Résolution 0,2°C, sonde inox repliable, convertible °C/°F

Genauigkeit Infrarot / Exactitude infra-rouge
± 1°C (-0°C...+65°C)

Genauigkeit Fühler/ Exactitude sonde
± 0,5°C (-5°C...+65°C)

Art-Nr./No d'article	Messbereich/portée de mesure	Preis/prix
8006.90851	-55°C - +330°C	296.40

Thermometer
Thermomètre

Prüfstab und Fassung mit Klemme aus Inox 18/10, Schutzkappe aus Kunststoff, kalibrierbar, Skala -10° bis +100° C
gradué de -10° à +100° C

Genauigkeit / Exactitude ± 2°C

Art-Nr./No d'article	Länge/longueur	Preis/prix
8006.42323	14 cm	7.95

«TESTO 270»
Frittieröltester
Testeur d'huile de friture

Der Frittieröltester Testo270 stellt einfach, schnell und zuverlässig die Qualität von Frittieröl fest. Ist das Öl zu alt, wird qualitativ schlechtes Frittiertgut produziert. Zudem können dann gesundheitlich bedenkliche Stoffe darin enthalten sein. Die regelmässige Messung mit dem Testo270 verhindert dies. Ebenso schliesst der Einsatz des Messgerätes aus, dass Frittieröl zu früh gewechselt wird. Das reduziert den Frittierölverbrauch um bis zu 20% und senkt so die Kosten. Eindeutige Alarmierung nach dem Ampelprinzip über beleuchtetes Display. Abwaschbar unter fließendem Wasser. **Die Lebensdauer des Frittieröls wird optimal genutzt. Das Öl wird erst gewechselt, wenn der Grenzwert erreicht ist.**

*Le testeur d'huile de friture Testo270 détermine aisément, rapidement et de manière fiable la qualité des huiles de friture. Une huile trop ancienne réduit la qualité des aliments frits. Ils peuvent en outre contenir des substances nocives pour la santé. Une mesure régulièrement au moyen du Testo270 permet d'empêcher cela. L'utilisation de l'appareil de mesure permet en outre d'éviter de remplacer l'huile de friture trop tôt. La consommation d'huile de friture peut ainsi être réduite de jusqu'à 20%. Alarme claire selon un principe de feux de signalisation. Lavable sous l'eau courante. **La durée de vie de l'huile de friture est utilisée de façon optimale. L'huile ne doit être changée que lorsque la valeur limite est atteinte.***

Genauigkeit/Exactitude ± 2%TPM (+40...+190°C)
± 1,5°C

Art-Nr./No d'article	Messbereich/portée de mesure	Preis/prix
8006.95000	+40...+200°C	647.00

«TESTO»
Referenzöl
Huile de référence

Mit Hilfe des Referenzöls können Sie einen Testo Frittieröltester kalibrieren oder justieren. Tauchen Sie einfach das Messgerät (im Kalibriermodus) in das auf ca. 50° C erhitzte Öl. Für die Kalibrierung wird die Anzeige auf dem Messgerät mit dem aufgedruckten Wert auf der Flasche des Referenzöls verglichen und notiert. Oder justieren Sie das Messgerät auf diesen Wert.

L'huile de référence vous permet d'étalonner ou d'ajuster un testeur d'huile de friture de Testo. Plongez tout simplement l'appareil de mesure (en mode d'étalonnage) dans l'huile chauffée à env. 50° C. Pour l'étalonnage, l'affichage de l'appareil de mesure est comparé à la valeur imprimée sur le flacon de l'huile de référence et noté. Ou bien vous ajustez l'appareil de mesure sur cette valeur.

Art-Nr./No d'article	Grösse/grandeur	Preis/prix
8006.95001	100 ml	35.05

Kühlschrank-Thermometer
Thermomètre frigo

Skala -50° bis 50° C
gradué de -50° à + 50° C

Art-Nr./No d'article	Grösse/grandeur	Preis/prix
8006.90852	Ø 60 mm	13.50

Kühlschrank-Thermometer
Thermomètre frigo

Skala -20 bis + 50° C
gradué de -20° à + 50° C, à alcool

Art-Nr./No d'article	Länge/longueur	Preis/prix
8006.90564	14,5 cm	8.20

Thermometer Tiefkühler
Thermomètre congélateur

voll synthetisch, mit Alkohol, Skala -40° bis +50° C
en plastique, à alcool, gradué de -40° à + 50° C

Art-Nr./No d'article	Länge/longueur	Preis/prix
8006.95071	20 cm	6.10



Ofen-Thermometer
Thermomètre pour four
Skala +50° bis 300° C
gradué de + 50° à + 300° C

Art-Nr./No d'article
8006.90568

Preis/prix
32.30



Fleischthermometer
Thermomètre à viande
Skala 0° bis 120° C, Sonde Inox 18/10
gradué de 0° à + 120° C, sonde en inox 18/10

Art-Nr./No d'article Länge/longueur
8006.90569 95 mm

Preis/prix
24.90



TTM Thermometer «Culinaire»
Thermomètre TTM «Culinaire»
Inox 18/10, verstellbare indexanzeige,
Skala 0° bis 200° C
Inox 18/10, index mobile, gradué de 0° à 200° C

Art-Nr./No d'article Länge/longueur
8006.90567 12 cm

Preis/prix
37.60



Barista-Thermometer
Thermomètre à barista
Messbereich -15°C bis +100°C, kalibrierbar,
Prüfstab und Fassung mit Klemme aus Edelstahl,
Schutzkappe aus Polycarbonat, einschliesslich Clip
Plage de mesure de -15 °C à + 100 °C, calibrable,
doté d'un témoin de contrôle, d'un support avec
pince en acier inoxydable et d'un capuchon de
protection en polycarbonate, attache incluse

Art-Nr./No d'article Länge/longueur
8006.40610 16,5 cm

Preis/prix
11.70

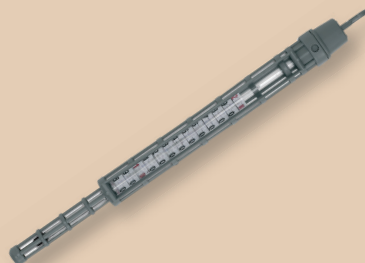

Zucker-Thermometer
Thermomètre confiseur
Edelstahlhülle, Skala 80° bis 200° C
Gaine en inox, gradué de 80° à 200° C

Art-Nr./No d'article Länge/longueur
8006.90864 30 cm

Preis/prix
49.35



Zuckerwaage
Pèse-Sirop
Glas, mit Skala von 1100 bis 1400g/l, mit Umrech-
nungsskala in Baumé-Grad
en verre, gradué de 1100 à 1400 g/l, avec conver-
sion en degré Baumé

Art-Nr./No d'article Länge/longueur
8006.95097 16 cm

Preis/prix
19.95



Testrohr für Zuckerwaage
Eprouvette Pèse-Sirop
Inox 18/10
Inox 18/10

Art-Nr./No d'article Länge/longueur Ø
8006.95099 17,5 cm 36 mm

Preis/prix
51.70



20 Stunden Timer-Schaltuhr
Minuteur 20 heures
Mit Digitalanzeige, Magnetrückwand mit Clip,
praktisches Taschenformat
A affichage digital, dos aimanté avec pince, tient
aisément dans une poche

Art-Nr./No d'article Grösse/grandeur
8006.90853 6 x 5 cm

Preis/prix
27.75



99 Minuten Timer
Minuteur 99 minutes
Für genaue Garzeiten in Sekunden einstellbar,
lauter Klingelton, Magnetrückwand mit Clip,
praktisches Taschenformat
Paramétrable en secondes pour les justes cuis-
sons, sonnerie puissante, dos aimanté avec pince,
modèle de poche

Art-Nr./No d'article Grösse/grandeur
8006.95084 6 x 5 cm

Preis/prix
21.15

ETIKETTIERGERÄTE / ÉTIQUETEUSES



abgepackt am:
24.12.19

«Swing 8.26» Set Handetikettierapparat, 1 Zeiler Appareil d'étiquetage à mains

Auszeichnungsgerät für Etiketten, für Preisdarstellung oder Datum geeignet, 1 x 8-stelliges Druckwerk

Appareil d'étiquetage, approprié pour descriptions de prix ou de dates, Élément d'impression à 1 ligne

Art-Nr./No d'article	Grösse/grandeur		Preis/prix
8006.92200	26 x 12 mm	Deutsch	324.65/Set
8006.92210	26 x 12 mm	Français	324.65/Set

Gratis im Set 1 x Kleinkarton mit Etiketten Gratuit dans le set 1 x carton d'étiquettes petit

Tiefkühlgeeignet, 10 Rollen à 1500 Etiketten,
Vordruck: abgepackt am:

Approprié pour la surgélation, 10 rouleaux à 1500 étiquettes, Text français: emballé le:

abgepackt am:
24.12.19

emballé le:
24.12.19

Etiketten Ersatzrollen Rouleaux de rechange d'étiquettes

Tiefkühlgeeignet, 10 Rollen à 1500 Etiketten
Vordruck: abgepackt am:

Approprié pour la surgélation,
10 rouleaux à 1500 étiquettes,
Text français: emballé le:

Art-Nr./No d'article	Grösse/grandeur		Preis/prix
8006.92201	26 x 12 mm	Deutsch	109.85
8006.92211	26 x 12 mm	Français	109.85

Ersatz-Farbrolle schwarz Rouleaux dencre noir

Art-Nr./No d'article	Preis/prix
8006.92700	10.55



24.12.19
abgepackt am:
zu verbrauchen bis:
31.12.19

«Swing Sous-Vide» Set Handetikettierapparat, 2 Zeiler Appareil d'étiquetage à mains

Auszeichnungsgerät für Etiketten, für Preisdarstellung oder Datum geeignet, 2 x 9-stelliges Druckwerk

Appareil d'étiquetage, approprié pour descriptions de prix ou de dates, Élément d'impression à 2 lignes

Art-Nr./No d'article	Grösse/grandeur		Preis/prix
8006.92220	26 x 16 mm	Deutsch	489.35/Set
8006.92230	26 x 16 mm	Français	489.35/Set

Gratis im Set 1 x Kleinkarton mit Etiketten Gratuit dans le set 1 x carton d'étiquettes petit

Tiefkühlgeeignet, 10 Rollen à 1100 Etiketten,
Vordruck: abgepackt am: / zu verbrauchen bis:

Approprié pour la surgélation, 10 rouleaux à 1100 étiquettes, Text français: emballé le: / à consommer jusqu'au:

24.12.19
abgepackt am:
zu verbrauchen bis:
31.12.19

24.12.19
emballé le:
à consommer jusqu'au:
31.12.19

Etiketten Ersatzrollen Rouleaux de rechange d'étiquettes

Tiefkühlgeeignet, 10 Rollen à 1100 Etiketten,
Vordruck: abgepackt am: / zu verbrauchen bis:

Approprié pour la surgélation,
10 rouleaux à 1100 étiquettes,
Text français: emballé le: / à consommer jusqu'au:

Art-Nr./No d'article	Grösse/grandeur		Preis/prix
8006.92221	26 x 16 mm	Deutsch	117.25
8006.92231	26 x 16 mm	Français	117.25

Ersatz-Farbrolle schwarz Rouleaux dencre noir

Art-Nr./No d'article	Preis/prix
8006.92700	10.55





«Multitext» Set
Datiergerät mit 13 wählbaren Texten
Appareil de datation avec 13 textes à choisir

Deutsch: abgepackt am: | verbrauchen bis: | eingefroren am: | aufgetaut am: | aus Tiefkühler: | in Kühler: | aus Kühler: | produziert am: | geöffnet am: | mind. haltbar bis: | Wareneingang: | sterilisiert am: | verfallen am:

Français: emballé le: | à cons. Jusqu'au: | congelé le: | décongelé le: | du congélateur: | dans le frigo: | du refroidisseur à: | produit le: | ouvert le: | valable jusqu'au: | entrée de marchandises: | stérilisé le: | périmé le:

Italiano: Confezionato il: | Consumare entro: | Congelato il: | Scongelato il: | Produzione del: | Pastorizzato il: | Consumare pref. entro: | Prezzo Fr. | Aperto il: | Entrata merce: | L.int: | Lotto:

Gratis Starter-Set «tiefkühl»
Set de démarrage gratuit «surgélation»

5 Rollen à 1100 Etiketten, tiefkühlgeeignet,
 1 Ersatz-Farbrolle
 5 rouleaux à 1100 étiquettes, approprié pour la surgélation, 1 rouleaux dencre noir

Art-Nr./No d'article	Grösse/grandeur	Deutsch	Preis/prix
8006.92801	26 x 16 mm	Deutsch	446.80/Set
8006.92803	26 x 16 mm	Français	446.80/Set
8006.92805	26 x 16 mm	Italiano	446.80/Set

Gratis Starter-Set «ablösbar»
Set de démarrage gratuit «détachable»

5 Rollen à 1100 Etiketten, ablösbar,
 1 Ersatz-Farbrolle
 5 rouleaux à 1100 étiquettes, détachable, 1 rouleaux dencre noir

Art-Nr./No d'article	Grösse/grandeur	Deutsch	Preis/prix
8006.92802	26 x 16 mm	Deutsch	446.80/Set
8006.92804	26 x 16 mm	Français	446.80/Set
8006.92806	26 x 16 mm	Italiano	446.80/Set



Etiketten Ersatzrollen
Rouleaux de rechange d'étiquettes

10 Rollen à 1100 Etiketten, Total 11'000
 10 rouleaux à 1100 étiquettes, totale 11'000

weiss/blanc	ablösbar/détachable	Preis/prix
8006.92501	ablösbar/détachable	96.20
8006.92502	permanent/permanente	96.20
8006.92503	tiefkühl/surgelé	96.20

blau/bleu	tiefkühl/surgelé	Preis/prix
8006.92504	tiefkühl/surgelé	96.20

leuchtrot/rouge	tiefkühl/surgelé	Preis/prix
8006.92505	tiefkühl/surgelé	96.20
8006.92506	ablösbar/détachable	96.20

Ersatz-Farbrolle schwarz
Rouleaux dencre noir

Art-Nr./No d'article	Preis/prix
8006.92600	10.55



«Multitext PLUS» Set
Datiergerät mit 10 wählbaren Texten
Appareil de datation avec 10 textes à choisir

Deutsch: abgepackt am: | aus Tiefkühler: | produziert am: | in Kühler am: | geöffnet am: | eingefroren am: | aus Kühler am: | aufgetaut am: | sterilisiert am: | Wareneingang: | zu verbrauchen bis ist auf jedem Etikett vorhanden.

Français: emballé le: | du congélateur: | produit le: | congelé le: | stérilisé le: | mis au frigo: | ouvert le: | sorti du frigo: | décongelés le: | entrée de marchandises:

Italiano: Confezionato il: | Produzione del: | Congelato il: | Prezzo Fr. | Lotto: | Aperto il: | Entrata merce: | Scongelato il: | Pastorizzato il: | L.int:

Gratis Starter-Set «tiefkühl»
Set de démarrage gratuit «surgélation»

5 Rollen à 700 Etiketten, tiefkühlgeeignet,
 1 Ersatz-Farbrolle
 5 rouleaux à 700 étiquettes, approprié pour la surgélation, 1 rouleaux dencre noir

Art-Nr./No d'article	Grösse/grandeur	Deutsch	Preis/prix
8006.92810	29 x 28 mm	Deutsch	587.00/Set
8006.92820	29 x 28 mm	Français	587.00/Set
8006.92830	29 x 28 mm	Italiano	587.00/Set

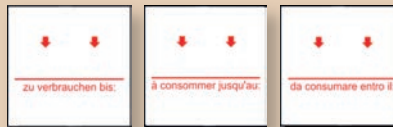

Etiketten Ersatzrollen
Rouleaux de rechange d'étiquettes

Tiefkühlgeeignet, 10 Rollen à 700 Etiketten,
 Vordruck: zu verbrauchen bis:
 Approprié pour la surgélation,
 10 rouleaux à 700 étiquettes,
 Text français: à consommer jusqu'au:
 Text italiano: da consumare entro il:

Art-Nr./No d'article	Grösse/grandeur	Deutsch	Preis/prix
8006.92835	29 x 28 mm	Deutsch	96.20
8006.92836	29 x 28 mm	Français	96.20
8006.92837	29 x 28 mm	Italiano	96.20

Ersatz-Farbrolle schwarz
Rouleaux dencre noir

Art-Nr./No d'article	Preis/prix
8006.92705	17.95

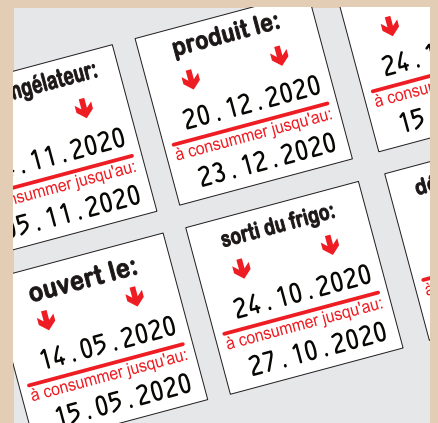
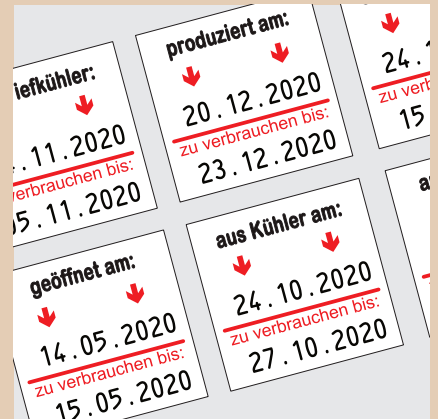

KOCHAPPARATE 568

Induktionskocher/Elektrokocher
 Kontaktgrill
 Sous-Vide-Garer
 Salamander
 Friteusen
 Reiskocher
 Eierkocher
 Toaster

WARMHALTEAPPARATE 584

Bain Marie
 Warmhalte-/Niedertemperatur-Gargerät
 Wärmebrücken/Wärmelampen
 Suppentöpfe
 Wärmeschrank/Tellerwärmer

HEISSGETRÄNKE 592

Glühwein- und Einkochautomat
 Heissgetränke-Dispenser
 Kaffeemaschinen
 Samovar

KÜCHENMASCHINEN 596

Mixer/Rührstab
 Rühr-, Knet-, Mischmaschine
 Saftpresse
 Pastamaschinen
 Schneidmaschinen
 Universalwaagen
 Vakuum-Verpackungsmaschinen

KÜHLAPPARATE 621

Kühlvitrienen/Kühlschränke
 Ice Crusher/Eiswürfelmaschinen

BARMASCHINEN 624

Blender/Mixer

RACLETTE 626**APPAREILS DE CUISSON 568**

Réchaud à induction/électrique
 Grill à plaques
 Cuisson-sous-vide
 Salamandre
 Friteuses
 Cuiseur à riz
 Cuiseur à œufs
 Toaster

APPAREILS CHAUFFANTS 584

Bain Marie
 Appareil de maintien au chaud
 Pont infrarouge/lampes
 Chaudrons à potage
 Armoire chauffante/chauffe-assiettes

BOISSONS CHAUDES 592

Stérilisateur automatique
 Distributeur à boissons chaudes
 Machines à café
 Samovar

MACHINES DE CUISINE 596

Mixeur
 Machine à malaxer, pétrir et mélanger
 Centrifugeuse
 Machine à pâtes
 Trancheuses
 Balances universelle
 Appareil à emballer sous vide

APPAREILS FRIGORIFIQUES 621



Vitrine réfrigérée/réfrigérateur
 Broyeur à glaçons/Machine à glaçons

MACHINES DU BAR 624

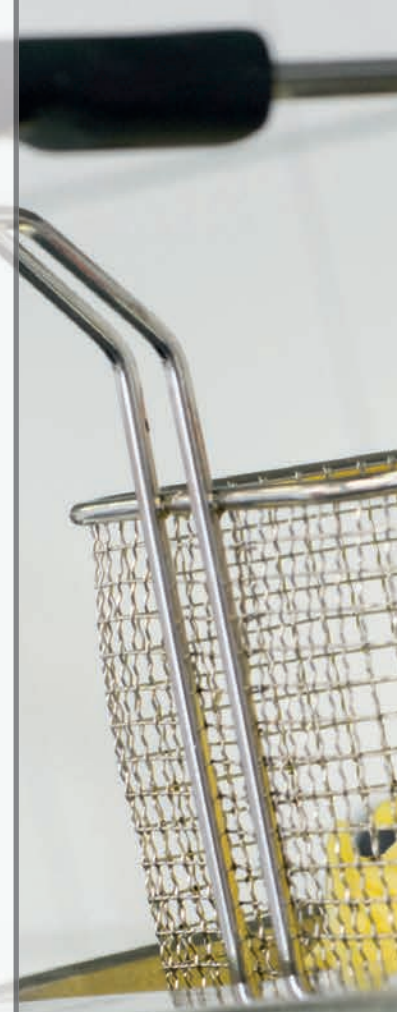
Mixer

RACLETTE 626

APPARATE APPAREILS

 Schwarze Artikelnummern: Numéros de référence noirs:	Lagerartikel (Zwischenverkauf vorbehalten) article en stock (sous réserve de vente intermédiaire)
 Grüne Artikelnummern: Numéros de référence verts :	Lieferzeit 2 bis max. 4 Wochen délai de livraison 2 à max. 4 semaines
 Rote Artikelnummern: Numéros de référence rouges:	Lieferzeit 4 bis max. 12 Wochen (Sonderanfertigungen) délai de livraison 4 à max. 12 semaines (réalisations spéciales)

Bei Lieferfristen von über 12 Wochen werden Sie informiert.
En cas de livraison de plus de 12 semaines, vous serez informés.

KOCHAPPARATE / APPAREILS DE CUISSON



T23



Heissluftofen Four à convection

Edelstahl innen und aussen, Innenbeleuchtung, Tür mit Doppelscheibe, abgerundete Backkammer, Temperaturschalter: 0 - 280 °C, Zeitschalter: 0-120 Minuten, Abstand zwischen den Blechen 75 mm, Einschübe: 4 (442 x 325mm), Multifunktionschalter für Grill, Heissluft und Ober-/Unterhitze, oberer und unterer Temperaturwahlschalter, mit Beschwadung, Lieferung inklusive 4 Bleche
Entièrement en acier inoxydable, éclairage intérieur, porte à double vitrage, enceinte à angles arrondis, plage de température : 0 - 280 °C, minuterie: 0-120 minutes, espacement entre grilles 75 mm, contenance: 4 x 442 x 325 mm, manette multifonction pour grill, convection, chaleur voûte/sol, sélection chaleur voûte ou sol, avec vapeur, dotation: 4 plaques

Art-Nr./No d'article	Grösse/grandeur	Gewicht/poids	Anschluss/puissance	Preis/prix
8270.90120	55 x 64 x H 54,5 cm	30,6 kg	230 V / 2,6 kW	2069.80

Zubehör/Accessoires

8270.90121	Blech/plaque	442 x 325 mm	44.65
8270.90122	Rost/grille	442 x 325 mm	41.15



T13



«Elegance» Induktionskochplatte Plaque de cuisson à induction

Induktionskochplatte mit 6 Leistungsstufen von 200 - 2000 W, Temperatureinstellung in 10 Stufen von 60°C bis 240°C, Glaskeramik-Oberfläche, Glasplattengrösse 29 x 28 cm für Induktionstöpfe, Touchpad-Bedienfeld mit grosser Digitalanzeige, Timer mit Zeitvorwahl von 0 bis 180 Minuten einstellbar, Automatische Anpassung an Stromschwankungen, automatische Abschaltung nach 2 Stunden, automatische Erkennung von geeigneten/ungeeigneten Töpfen, Timer mit Zeitvorwahl, Überhitzungsschutz, Kindersicherung

Plaque électrique à induction, 6 niveaux de puissance de 200 - 2000 W, réglage de la température à 10 positions de 60°C à 240°C, surface vitrocéramique, grandeur de la plaque de cuisson 29 x 28 cm, conçue pour des casseroles à induction, panneau de commande muni de touches à effleurement avec grand affichage numérique, minuterie avec présélection de 0 à 180 minutes, adaptation automatique du niveau de tension, arrêt automatique après 2 heures, détection automatique à savoir si les casseroles sont adaptées ou non, protection contre la surchauffe, sécurité enfants

Art-Nr./No d'article	Grösse/grandeur	Anschluss/puissance	Preis/prix
8006.96230	29 x 35,5 x 7 cm / 2,59 kg	230 V / 2 kW	109.85



T23



**Induktionskochplatte
Réchaud à induction**

Kochfläche Glas, Gehäuse Edelstahl, Timer, LED-Display, 10 Leistungsstufen (500 – 3500 W), 10-stufige Temperatureinstellung (60 °C – 240 °C)
Surface de cuisson en verre, boîtier: acier inoxydable, minuterie, affichage LED, 10 niveaux de puissance (500 – 3500 W), 10 niveaux de température (60 °C – 240 °C)

Art-Nr./No d'article	Grösse/grandeur	Anschluss/puissance	Preis/prix
8270.90075	34,3 x 44,3 x H 11,8 cm	230 V / 3,5 kW	489.35



T13

8270.90260



T23

**8270.90261
8270.90262**



**Induktionskochplatte
Réchaud à induction**

Extraflach, Gehäuse aus Edelstahl, Glaskeramik-Oberfläche, Touchpad-Bedienfeld mit Digitalanzeige, Temperatureinstellung in 15 Stufen, Timer mit Zeitwahl bis 99 Minuten einstellbar (ausser 1,8 kW), thermischer Überlastungsschutz der Induktion zur automatischen Heizleistungsminderung bei Überhitzung, zur Reinigung ausbaubarer Luftfilter, Anzeige bei Spannungsführung ohne Kochgefäss, Verwendbar mit induktionsfähigen Kochgefässen mit einem Durchmesser von 120 bis 280 mm (bis 320 mm bei Modell 3,5 kW).

Ultra-plate, carrosserie en inox, dessus vitrocéramique épaisseur, commandes à touches sensibles avec affichage digital, variateur de puissance à 15 positions, minuterie 99 minutes (sauf 1,8 kW), protection thermique de l'inducteur: puissance réduite en cas de surchauffe, filtre à air amovible et nettoyable, témoin visuel d'absence de récipient, accepte les récipients à induction de 120 à 280 mm (3,5 kW = à 320 mm de diamètre).

Art-Nr./No d'article	Grösse/grandeur	Gewicht/poids	Anschluss/puissance	Preis/prix
8270.90260	30,5 x 30,5 x 8,0 cm	4,35 kg	230 V / 1,8 kW	1398.75
8270.90261	46,0 x 36,5 x 8,0 cm	6,25 kg	230 V / 2,8 kW	1763.45
8270.90262	50,0 x 36,5 x 9,5 cm	8 kg	250 V / 3,5 kW	2341.15



T23



**Induktionskochplatte
Réchaud à induction**

Optimale Energieverteilung durch Leistungszuschaltung. Kochfläche aus Glas, 3 Kochfelder (Leistung max. 1000 W / 1400 W / 2000 W), 10 Temperaturstufen von 60°C bis 240°C, Zeiteinstellung 1 bis 180 Minuten, Überhitzungsschutz, Digitalanzeige auf der Kochfläche mit Touch-Steuerung
Répartition optimale de l'énergie grâce à une mise sous tension. Surface de cuisson en verre, 3 plaques de cuisson (puissance max. 1 000 W/1 400 W/2 000 W), 10 niveaux de température de 60 °C à 240 °C, réglage du temps de 1 à 180 minutes, protection contre la surchauffe, affichage numérique sur la surface de cuisson avec commande tactile

Art-Nr./No d'article	Grösse/grandeur	Gewicht/poids	Anschluss/puissance	Preis/prix
8270.90940	51 x 48,5 x 6,5 cm	6,6 kg	230 V / 3,4 kW	694.00



T13



Induktionskocher IK 20TC Réchaud à induction IK 20TC

Induktionskochfeld aus Glas, Regulierung von Leistung/Temperatur und Zeit möglich, Steuerung mit Touch-Funktion, Temperaturbereich zwischen 60°C bis 240°C, Durchmesser Kochfeld 22,8 cm.

Table de cuisson à induction en verre, réglage possible de la puissance/température et du temps, commande avec fonction tactile, plage de température entre 60°C et 240°C, diamètre de la table de cuisson 22,8 cm.

Art-Nr./No d'article	Grösse/grandeur	Anschluss/puissance	Preis/prix
8270.90073	33 x 40 x H 6,3 cm	230 V / 2000 W	234.05



T13



WMF «KultX» Induktionskochplatte Plaque de cuisson à induction

Einzel- Induktionskochplatte aus Glaskeramik, Kochplatte bis 28cm, 1 Kochfeld, 8 Stufen, Topferkennung, Touch-Display, mit Timer-Funktion, mit 6 Direktwahlprogrammen

Plaque de cuisson individuelle à induction en vitrocéramique, Plaque de cuisson jusqu'à 28cm, 1 foyer, 8 niveaux, détection de casserole, écran tactile, avec fonction minuterie, avec 6 programmes à sélection directe

Art-Nr./No d'article	Grösse/grandeur	Gewicht/poids	Anschluss/puissance	Preis/prix
04.1524.0011	29,1 x 37,1 x H 4,8 cm	2,3 kg	220 V / 2205w	93.85



T23



WMF «KultX» Induktionskochplatte Plaque de cuisson à induction

Doppel-Induktionskochplatte aus Glaskeramik, Kochplatte bis 28cm, 1 Kochfeld, 8 Stufen, Topferkennung, Touch-Display, mit Timer-Funktion, mit 6 Direktwahlprogrammen

Plaque de cuisson double à induction en vitrocéramique, plaque de cuisson jusqu'à 28cm, 1 foyer, 8 niveaux, détection de casserole, écran tactile, avec fonction minuterie, avec 6 programmes à sélection directe

Art-Nr./No d'article	Grösse/grandeur	Gewicht/poids	Anschluss/puissance	Preis/prix
04.1532.0011	29,1 x 37,1 x H 4,8 cm	2,3 kg	220 V / 3500 W	211.15



T13



Elektro-Kochplatte Réchaud électrique

Edelstahl, 1 Kochfeld Ø 185 mm, Leistung stufenlos verstellbar, Überhitzungsschutz, Kontrollleuchte

Inox, 1 zone de cuisson Ø 185 mm, contrôle de la température par réglage en continu, protection surchauffe, lampe de contrôle

Art-Nr./No d'article	Grösse/grandeur	Gewicht/poids	Anschluss/puissance	Preis/prix
8270.90910	30,5 x 24,5 x H 8,5 cm	2,1 kg	230 V / 1,5 kW	76.20



T23



Elektro-Kochplatte Réchaud électrique

Edelstahl, 2 Kochfelder nebeneinander, Kochfeld links Ø 155 mm (max. 1 kW), Kochfeld rechts Ø 190 mm (max. 1,5 kW), Leistung stufenlos verstellbar, Überhitzungsschutz, Kontrollleuchte

Inox, 2 zones de cuisson, zone de cuisson à gauche Ø 155 mm (1 kW max.), zone de cuisson à droite Ø 190 mm (1,5 kW max.), contrôle de la température par réglage en continu, protection surchauffe, lampe de contrôle

Art-Nr./No d'article	Grösse/grandeur	Gewicht/poids	Anschluss/puissance	Preis/prix
8270.90920	53,5 x 22,5 x H 9 cm	4 kg	230 V / 2,5 kW	104.20



T13



Elektro-Glaskeramik-Kochplatte Plaque de cuisson électrique vitrocéramique

Gehäuse und Boden aus hochwertigem Edelstahl, energiesparendes Infrarotheizelement und widerstandsfähige Kristallit-Glasplatte, Platte ca. Ø 20 cm, für alle Topf- und Pfannenarten geeignet, regelbares Thermostat, Betriebskontrollleuchte, Überhitzungsschutz, Cool-Touch-Griffe aus Aluminium, Antirutschfüsse für einen sicheren Stand

Boîtier et base en inox de haute qualité, élément chauffant infrarouge à économie d'énergie et plaque en verre cristallite résistant, plaque d'environ Ø 20 cm, convient à tous les types de casseroles et poêles, thermostat réglable, voyant de contrôle de fonctionnement, protection contre la surchauffe, poignées Cool-Touch en aluminium, pieds antidérapants pour un positionnement stable

Art-Nr./No d'article	Grösse/grandeur	Gewicht/poids	Anschluss/puissance	Preis/prix
8270.90931	35 x 32 x H 7 cm	2,04 kg	230 V / 2 kW	82.10

KOCHAPPARATE / APPAREILS DE CUISSON



T13

Elektro-Kontaktgrill
Grill contact

Robustes Gehäuse aus CNS, Grillplatten oben gerillt - unten glatt, aus Gusseisen für optimale Wärmeübertragung, Thermostat regelbar von 50° bis 300° C, Aufheizkontrollleuchte, Kontrollleuchte EIN/AUS, Fettauffangschale, Bratfläche: 1 x 21,4 x 21,4 cm

Habillage en inox, plaques dessus rainurée - dessous lisse, en fonte d'acier avec répartition optimale de la chaleur, thermostat réglable de 50° à 300° C, témoin de chauffe et d'enclenchement, bac récolte graisses, surface de cuisson: 1 x 21,4 x 21,4 cm

Art-Nr./No d'article	Grösse/grandeur	Gewicht/poids	Anschluss/puissance	Preis/prix
8270.90060	29 x 40 x H 20 cm	15 kg	230 V / 1,8 kW	489.35



T23

Elektro-Kontaktgrill
Grill contact

Robustes Gehäuse aus CNS, Grillplatten oben gerillt - unten glatt, aus Gusseisen für optimale Wärmeübertragung, Thermostat regelbar von 50° bis 300° C, Aufheizkontrollleuchte, Kontrollleuchte EIN/AUS, Fettauffangschale, Bratfläche: 2 x 21,5 x 21,5 cm

Habillage en inox, plaques dessus rainurée - dessous lisse, en fonte d'acier avec répartition optimale de la chaleur, thermostat réglable de 50° à 300° C, témoin de chauffe et d'enclenchement, bac récolte graisses, surface de cuisson: 2 x 21,5 x 21,5 cm

Art-Nr./No d'article	Grösse/grandeur	Gewicht/poids	Anschluss/puissance	Preis/prix
8270.90061	57 x 40 x H 20 cm	30,5 kg	230 V / 3,6 kW	869.95



T13

Elektro-Kontaktgrill
Grill contact

Robustes Gehäuse aus CNS, Grillplatten oben und unten gerillt, aus Gusseisen für optimale Wärmeübertragung, Thermostat regelbar von 50° bis 300° C, Aufheizkontrollleuchte, Kontrollleuchte EIN/AUS, Fettauffangschale, Bratfläche: 33,5 x 22 cm

Habillage en inox, plaques dessus et dessous rainurée, en fonte d'acier avec répartition optimale de la chaleur, thermostat réglable de 50° à 300° C, témoin de chauffe et d'enclenchement, bac récolte graisses, surface de cuisson: 33,5 x 22 cm

Art-Nr./No d'article	Grösse/grandeur	Gewicht/poids	Anschluss/puissance	Preis/prix
8270.90062	41 x 40 x H 20 cm	20 kg	230 V / 2,2 kW	552.90



T13



**Salamander
Salamandre**

Gehäuse Chromnickelstahl, Zeitschaltuhr, Simmerstat, inkl. 1 Rost
Habillage en acier inoxydable, minuterie, rhéostat, 1 grille incluse

Art.-Nr./No d'article	Grösse/grandeur	Gewicht/poids	Anschluss/puissance	Preis/prix
8270.90042	61 x 30,5 x H 28 cm	14,6 kg	230 V / 2,0 kW	541.15



T23



**Hi-Light-Salamander GN 2/3
Salamandre Hi-Light-Lift GN 2/3**

Sehr schnelle Aufheizzeit (ca. 5 Sekunden), erhebliche Energieeinsparung von bis zu 65% gegenüber herkömmlichen Salamandern, angenehmes Arbeitsklima in der Küche dank weniger Abwärme, Knebelbedienung, höhenverstellbare Heizelemente, Masse Grillrost 39 x 30,5 cm
Temps de chauffe très rapide (env. 5 secondes), économie d'énergie considérable allant jusqu'à 65% par rapport aux salamandres traditionnelles, ambiance de travail agréable dans la cuisine grâce à la réduction de la chaleur dégagée, commande par manette, éléments chauffants réglables en hauteur, dimensions de la grille 39 x 30,5 cm

Art.-Nr./No d'article	Grösse/grandeur	Gewicht/poids	Anschluss/puissance	Preis/prix
8270.90280	40 x 53 x H 51,5 cm	30 kg	230 V / 3 kW	2821.15



**ANSCHLUSS BAUSEITIG!
CONNEXION
MONTÉE SUR SITE!**



T15



**Hi-Light-Salamander GN 1/1
Salamandre Hi-Light-Lift GN 1/1**

Sehr schnelle Aufheizzeit (ca. 5 Sekunden), erhebliche Energieeinsparung von bis zu 65% gegenüber herkömmlichen Salamandern, angenehmes Arbeitsklima in der Küche dank weniger Abwärme, Knebelbedienung, höhenverstellbare Heizelemente, mit Warmhaltefunktion, Lieferung inklusive Wandbefestigung, Masse Grillrost 56 x 35,8 cm
Temps de chauffe très rapide (env. 5 secondes), économie d'énergie considérable allant jusqu'à 65% par rapport aux salamandres traditionnelles, ambiance de travail agréable dans la cuisine grâce à la réduction de la chaleur dégagée, commande par manette, éléments chauffants réglables en hauteur, avec fonction de maintien au chaud, livraison avec fixation murale, dimensions de la grille 56 x 35,8 cm

Art.-Nr./No d'article	Grösse/grandeur	Gewicht/poids	Anschluss/puissance	Preis/prix
8270.90281	57 x 50 x H 52 cm	50 kg	400 V / 4,5 kW	3517.40



**ANSCHLUSS BAUSEITIG!
CONNEXION
MONTÉE SUR SITE!**

GOURMET-THERMAILISIERER THERMALISEUR GOURMET

Der Gourmet-Thermalisierer wurde in enger Zusammenarbeit mit erfahrenen Köchen für den Dauerbetrieb in Küchen entwickelt und optimiert.

Le thermaliseur Gourmet a été développé et optimisé en collaboration étroite avec des chefs expérimentés pour un fonctionnement continu en cuisine.

DIE WICHTIGSTEN VORTEILE:

- Kompakt und formschön
- Kleine Stellfläche bei grossem Volumen
- Hervorragendes Preis-Leistungs-Verhältnis
- Leicht verständliches Bedienfeld
- Professionelle und kundengerechte Bedienungsanleitung
- Für den Dauerbetrieb konstruiert
- Thermalisierer hat keine Pumpe, damit ist das Wasserbad langlebig, wartungs- und verschleissfrei
- Digitale Zeitsteuerung
- Temperaturgenauigkeit durch PID-Regler
- Die Temperatur ist an der Steuerung in 0,1 Grad Schritten einstellbar
- Temperatur-Einstellungsbereich: +25 °C bis + 85 °C
- Hochwertiges Edelstahlgehäuse mit Edelstahldeckel

LES PRINCIPAUX AVANTAGES:

- Compact et élégant
- Faible encombrement pour des grands volumes
- Excellent rapport qualité/prix
- Panneau de commande facile à comprendre
- Notice d'utilisation professionnelle et adaptée aux clients
- Conçu pour le fonctionnement continu
- Thermaliseur sans pompe afin que le bain d'eau soit durable, ne nécessite pas d'entretien et ne s'use pas
- Commande du temps numérique
- Précision de la température grâce à un régulateur PID
- Température réglable au niveau de la commande par pas de 0,1 degré
- Plage de réglage de la température: +25 °C à + 85 °C
- Boîtier en acier inoxydable de qualité avec couvercle en acier inoxydable

ZWEI GRÖSSEN, IDEAL FÜR JEDEN EINSATZ:

Zum Anfreunden, als Zweitgerät, für den mobilen Einsatz, für den Dauerbetrieb, für kleine oder grosse Portionen. Volle Nutzbarkeit des ganzen Behälters möglich, da von aussen beheizt. Keine störenden Bauteile innerhalb des Behälter, die das Volumen verringern und schwer zu reinigen sind.

DEUX TAILLES, IDÉALES POUR CHAQUE USAGE:

Pour les amis, comme deuxième appareil, en déplacement, pour un fonctionnement continu, pour des petites ou grandes portions. Utilisation de tout le volume du récipient grâce à un chauffage par l'extérieur. Aucun composant dérangent à l'intérieur du récipient, réduisant le volume et rendant l'appareil difficile à nettoyer.



JULIA



MELANIE



T13



KOMET «Julia» GN 2/3
Sous-Vide-Garer
Cuisson-sous-vide

14 Liter Wasserbad, GN 2/3, Edelstahl, Digitale Zeitsteuerung, Temperatur in 0,1°C Schritten einstellbar / + 25°C bis + 85°C, nicht zu gross und nicht zu klein
 idéal zum Thermalisieren von Fleisch, Fisch, Gemüse
 14 litre bain d'eau, GN 2/3, inox, commande de temps digitale, température réglable en marche de 0,1°C / +25°C à 85°C,
 ni trop grande, ni trop petite
 idéale pour la thermalisation de viandes, poissons et légumes

Art-Nr./No d'article	Grösse/grandeur	Anschluss/puissance	Preis/prix
8270.90366	35,5 x 36,5 cm x H 27,5 cm	230 V / 1,0 kW	1763.45



T13



KOMET «Melanie» GN 1/1
Sous-Vide-Garer
Cuisson-sous-vide

23 Liter Wasserbad, GN 1/1, Edelstahl, Digitale Zeitsteuerung, Temperatur in 0,1°C Schritten einstellbar / + 25°C bis + 85°C, ideal zum Thermalisieren von mehreren Gargutstücken gleichzeitig ideal zum Vorgaren und späteren Regenerieren
 23 litre bain d'eau, GN 1/1, inox, commande de temps digitale, température réglable en marche de 0,1°C / +25°C à 85°C,
 idéale pour la thermalisation de plusieurs morceaux simultanément
 idéale pour une cuisson anticipée et son utilisation ultérieure

Art-Nr./No d'article	Grösse/grandeur	Anschluss/puissance	Preis/prix
8270.90367	32,5x56,5cm xH 27,5 cm	230 V / 1,6 kW	2341.15

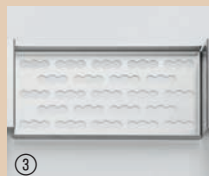

KOMET
Zubehör zu Sous-Vide-Garer
Accessoires por cuisson-sous-vide

Art-Nr./No d'article	Artikel/article	Preis/prix
8270.90372	① Elektrische Entleerung «Profí» Vidage electr. «Profí»	99.75
8270.90375	② Abtrenngitter zu «Julia» und «Melanie» Grille de séparation pour «Julia» et «Melanie»	123.50
8270.90376	③ Abdeckgitter zu «Julia» und «Melanie» Grille de protection pour «Julia» et «Melanie»	161.15
8270.90374	④ Anti-Dampf-Kugeln Set «Julia» Boules anti-vapeur en set «Julia»	104.20
8270.90380	④ Anti-Dampf-Kugeln Set «Melanie» Boules anti-vapeur en set «Melanie»	151.70



PEARL

Pearl garantiert eine Temperaturkonstanz von ± 0.03 °C in beliebigen Behältern mit einem Fassungsvermögen bis zu 58 Liter. Das mitgelieferte Schutzgitter verhindert den Kontakt der Vakuumbutel mit Heizspirale, Pumpe und Schwimmer. Durch die starke Umwälzpumpe ist eine optimale Temperaturkonstanz und gleichmässige Wasserverteilung im gesamten Bad garantiert. Dies wirkt sich auch positiv auf die Aufheizzeiten und beim Einlegen der gekühlten Lebensmittel aus.

Der integrierte Timer gibt jederzeit den Überblick über die noch verbleibende Garzeit. Darüber hinaus verfügt das Gerät über einen integrierten Dampfschutz, einen Alarm bei Wasserunterniveau sowie einen Spritzwasserschutz gemäss IPX4, wodurch ein sicheres Arbeiten gewährleistet wird. Die hygienische Antifingerprint-Edelstahlhaube sowie das leuchtstarke Display liefern ein modernes und passendes Design für Ihre Küche.

Pearl garantit une température constante à $\pm 0,03$ °C dans tout type de récipient d'une contenance allant jusqu'à 58 litres. La grille de protection, livrée avec l'appareil, empêche le contact du sachet sous vide avec la résistance chauffante, la pompe et le flotteur. La pompe de circulation puissante assure une température constante optimale et un brassage uniforme de l'eau dans toute la cuve. Cela a également un impact positif sur les temps de chauffe et la conservation des aliments réfrigérés.

La minuterie intégrée vous permet de garder constamment un œil sur le temps de cuisson restant. L'appareil est également équipé d'une protection antivapeur intégrée, d'une alerte en cas de niveau d'eau insuffisant, ainsi que d'une protection antiprojections d'eau selon IPX4, ce qui garantit un travail en toute sécurité. La tête de thermostat hygiénique en acier inoxydable antitrace et l'écran lumineux en font un objet moderne et design pour votre cuisine.



DIAMOND

Diamond vereint die einzigartigen Vorteile des Pearl mit zusätzlichen innovativen Funktionen wie vorprogrammierter Speichertaste für Fleisch, Fisch und Gemüse, einfaches HACCP Datalogging und Kalibrierfunktionen.

In Verbindung mit dem Kerntemperaturfühler wird bei Erreichen der eingestellten Kerntemperatur ein Alarm ausgegeben. Mit der Software Easy fusionchef können Sie bis zu 24 Diamond gleichzeitig steuern, visualisieren und die HACCP-relevanten Daten protokollieren.

Die getrennt voneinander startbaren Timer lassen Sie auch in hektischen Situationen stets den Überblick behalten. Der als nächstes ablaufende Timer wird ständig angezeigt, ein visuelles und akustisches Signal informiert Sie über den Ablauf der gewünschten Zeit. Anschliessend läuft der Timer ins Minus, damit Sie immer wissen, wie lange die eingestellte Zeit bereits abgelaufen ist.

Le modèle Diamond allie les avantages uniques du Pearl à des fonctions innovantes supplémentaires telles qu'une touche mémoire préprogrammée pour la viande, le poisson et les légumes, un enregistrement de données simple et conforme aux normes HACCP et des fonctions de calibration. Grâce à la sonde de température à cœur, une alarme se déclenche lorsque la température à cœur réglée est atteinte. Le logiciel Easy fusionchef permet de piloter et visualiser jusqu'à 24 appareils Diamond simultanément et de consigner les données pertinentes HACCP.

Les minuteries, qui peuvent être déclenchées séparément, permettent de toujours conserver une vue d'ensemble, même en cas de situations de stress. La prochaine minuterie à expirer s'affiche en permanence et un signal visuel et sonore vous informe de la fin de la durée souhaitée. Ensuite, la minuterie décompte le temps écoulé, afin que vous sachiez depuis combien de temps la durée réglée est dépassée.



T13



**FUSION CHEF by Julabo «Pearl»
Sous-Vide-Thermostat
Thermostat sous vide**

Basic-Thermostat zur Montage auf beliebigen Behältern (bis zu 58 Liter), einfache Montage mittels Befestigungsklammer (inkl.), Temperaturkonstanz von ± 0.03 °C, Temperaturbereich 20-95 °C, Wasserunterniveaualarm, Timer, Spritzwasserschutz gemäss IPX4, leuchtstarkes Display, Dampfschutz, Schutzgitter
 Thermostat de base pouvant être monté sur tout type de récipient (jusqu'à 58 litres), montage facile à l'aide d'attaches de fixation (fournies), température constante à $\pm 0,03$ °C, plage de températures de 20 à 95 °C, alerte de niveau d'eau insuffisant, minuteur, protection antiprojections d'eau selon IPX4, écran lumineux, protection antivapeur, grille de protection

Art.-Nr./No d'article	Grösse/grandeur	Gewicht/poids	Anschluss/puissance	Preis/prix
8270.96001	13,3 x 21,2 x H 33 cm	4,8 kg	230 V / 2 kW	2116.40



T13



**FUSION CHEF by Julabo «Diamond»
Sous-Vide-Thermostat
Thermostat sous vide**

Profi-Thermostat zur Montage auf beliebigen Behältern (bis zu 58 Liter), einfache Montage mittels Befestigungsklammer (inkl.), Temperaturkonstanz von ± 0.03 °C, Temperaturbereich 20-95 °C, Anschluss für Kerntemperaturfühler, Kerntemperaturalarm, Wasserunterniveaualarm, 3 Timer, Benutzergeführte Selbstkalibrierung, Spritzwasserschutz gemäss IPX4, leuchtstarkes Display, Dampfschutz, Schutzgitter
 Thermostat professionnel pouvant être monté sur tout type de récipient (jusqu'à 58 litres), montage facile à l'aide d'attaches de fixation (fournies), température constante à $\pm 0,03$ °C, plage de températures de 20 à 95 °C, raccord pour sonde de température à cœur, alerte de température à cœur, alerte de niveau d'eau insuffisant, 3 minuteurs, autocalibrage intuitif, protection antiprojections d'eau selon IPX4, écran lumineux, protection antivapeur, grille de protection.

Art.-Nr./No d'article	Grösse/grandeur	Gewicht/poids	Anschluss/puissance	Preis/prix
8270.96003	13,3 x 21,2 x H 33 cm	5,0 kg	230 V / 2 kW	3729.20



T13



**FUSION CHEF by Julabo «Pearl Z»
Sous-Vide-Thermostat
Thermostat sous vide**

Basic-Thermostat zur Montage auf beliebigen Behältern (bis zu 58 Liter), durch ausziehbare Brücke flexibel auf vorhandenen Gefässen einsetzbar, Temperaturkonstanz von ± 0.03 °C, Temperaturbereich 20-95 °C, Wasserunterniveaualarm, Timer, Spritzwasserschutz gemäss IPX4, leuchtstarkes Display, Dampfschutz, Schutzgitter
 Thermostat de base pouvant être monté sur tout type de récipient grâce à son pont extensible, température constante à $\pm 0,03$ °C, plage de températures de 20 à 95 °C, alerte de niveau d'eau insuffisant, minuteur, protection antiprojections d'eau selon IPX4, écran lumineux, protection antivapeur, grille de protection

Art.-Nr./No d'article	Grösse/grandeur	Gewicht/poids	Anschluss/puissance	Preis/prix
8270.96002	33,5 x 19 x H 33 cm	6,1 kg	230 V / 2 kW	2341.15



T13



**FUSION CHEF by Julabo «Diamond Z»
Sous-Vide-Thermostat
Thermostat sous vide**

Profi-Thermostat zur Montage auf beliebigen Behältern (bis zu 58 Liter), durch ausziehbare Brücke flexibel auf vorhandenen Gefässen einsetzbar, Temperaturkonstanz von ± 0.03 °C, Temperaturbereich 20-95 °C, Anschluss für Kerntemperaturfühler, Kerntemperaturalarm, Wasserunterniveaualarm, 3 Timer, Benutzergeführte Selbstkalibrierung, Spritzwasserschutz gemäss IPX4, leuchtstarkes Display, Dampfschutz, Schutzgitter
 Thermostat professionnel pouvant être monté sur tout type de récipient (jusqu'à 58 litres), montage flexible sur tout type de récipient grâce à son pont extensible, température constante à $\pm 0,03$ °C, plage de températures de 20 à 95 °C, raccord pour sonde de température à cœur, alerte de température à cœur, alerte de niveau d'eau insuffisant, 3 minuteurs, autocalibrage intuitif, protection antiprojections d'eau selon IPX4, écran lumineux, protection antivapeur, grille de protection.

Art.-Nr./No d'article	Grösse/grandeur	Gewicht/poids	Anschluss/puissance	Preis/prix
8270.96004	33,5 x 19 x H 33 cm	6,3 kg	230 V / 2 kW	4223.30

KOCHAPPARATE / APPAREILS DE CUISSON



T13

**FUSION CHEF by Julabo «Pearl S»
Sous-Vide-Thermostat**
Thermostat sous vide

Basic-Thermostat auf fester Brücke mit 19 Liter Bad (ummantelt), stabile Tragegriffe, Ablaufhahn, Baddeckel, Temperaturkonstanz von ± 0.03 °C, Temperaturbereich 20-95 °C, Wasserunterniveaualarm, Timer, Spritzwasserschutz gemäss IPX4, leuchtstarkes Display, Dampfschutz, Schutzgitter

Thermostat de base sur pont fixe avec bain-marie de 19 litres (revêtu), poignées robustes, robinet de vidange, couvercle pour bain-marie, constance de température de $\pm 0,03$ °C, gamme de température de 20 à 95 °C, alarme de sous-niveau d'eau, minuterie, protection contre les éclaboussures selon IPX4, écran lumineux, protection contre la vapeur, grille de protection.

Art-Nr./No d'article	Grösse/grandeur	Gewicht/poids	Anschluss/puissance	Preis/prix
8270.96005	33,2 x 57,7 x H 37,4 cm GN 1/1 - 150 mm	13,8 kg	230 V / 2 kW	3175.00

Weitere Modelle auf Anfrage.
Autres modèles sur demande.



T13

**FUSION CHEF by Julabo «Diamond S»
Sous-Vide-Thermostat**
Thermostat sous vide

Profi-Thermostat auf fester Brücke mit 19 Liter Bad (ummantelt), stabile Tragegriffe, Ablaufhahn, Baddeckel, Temperaturkonstanz von ± 0.03 °C, Temperaturbereich 20-95 °C, Anschluss für Kerntemperaturfühler, Kerntemperaturalarm, Wasserunterniveaualarm, 3 Timer, Benutzergeführte Selbstkalibrierung, Spritzwasserschutz gemäss IPX4, leuchtstarkes Display, Dampfschutz, Schutzgitter

Thermostat professionnel sur pont fixe avec bain-marie de 19 litres (revêtu), poignées robustes, robinet de vidange, couvercle pour bain-marie, constance de température de $\pm 0,03$ °C, gamme de température 20-95°C, connexion pour sonde de température à cœur, alarme de température à cœur, alarme de sous-niveau d'eau, 3 minuteries, auto-étalonnage guidé par l'utilisateur, protection contre les éclaboussures d'eau selon IPX4, écran lumineux, protection contre la vapeur, grille de protection

Art-Nr./No d'article	Grösse/grandeur	Gewicht/poids	Anschluss/puissance	Preis/prix
8270.96006	33,2 x 57,7 x H 37,4 cm GN 1/1 - 150 mm	14 kg	230 V / 2 kW	4975.00

Weitere Modelle auf Anfrage. Autres modèles sur demande.



①



②

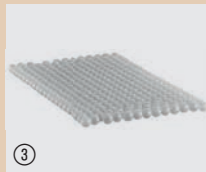

③



④



⑤



⑥



⑦

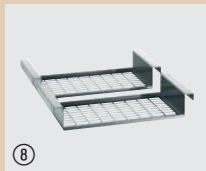

⑧



⑨



⑩

**FUSION CHEF by Julabo
Zubehör zu Sous-Vide-Thermostat
Accessoires pour thermostat sous vide**

Art-Nr./No d'article	Artikel/article	Preis/prix
8270.96010	① Kerntemperaturfühler zu Diamond <i>Sonde de température à cœur pour Diamond</i>	493.85
8270.96011	② Abdichtband zur Kerntemperaturmessung <i>Bande de recouvrement pour sonde de température à cœur</i>	117.25
8270.96012	③ Anti-Dampf-Kugeln, 1000 Stk. <i>Billes anti-vapeur, 1000 pcs.</i>	185.85
8270.96013	④ Timer-Markierungsband, 5 m, gelb <i>Ruban marqueur de minuterie, 5 m, jaune</i>	49.35
8270.96014	④ Timer-Markierungsband, 5 m, rot <i>Ruban marqueur de minuterie, 5 m, rouge</i>	49.35
8270.96015	④ Timer-Markierungsband, 5 m, blau <i>Ruban marqueur de minuterie, 5 m, bleu</i>	49.35
8270.96016	⑤ iSi Gourmet Halterung für 0,5 L Flaschen <i>iSi Gourmet support pour bouteilles de 0,5 L</i>	173.95
8270.96017	⑤ iSi Gourmet Halterung für 1 L Flaschen <i>iSi Gourmet support pour bouteilles de 1 L</i>	173.95
8270.96018	⑥ Badklammer zum montieren von Pearl und Diamond in grossen Kochtöpfen (bis 60 mm Wandstärke) <i>Pince de bain pour le montage de Pearl et Diamond dans de grandes casseroles (jusqu'à 60 mm d'épaisseur de paroi)</i>	117.25
8270.96019	⑦ Abtrenngitter für Edition S <i>Grille de séparation pour Edition S</i>	81.15
8270.96020	⑧ Abdeckgitter für Edition S <i>Grille de protection pour Edition S</i>	185.85
8270.96021	⑨ Transporttasche (Polyester) <i>Sac de transport (polyester)</i>	161.15
8270.96022	⑩ Transportkoffer <i>Caisse de transport</i>	1046.95



T13



Elektro-Tischfriteuse
Friteuse électrique

Chromnickelstahl, 1 Becken 4 Liter inkl. 1 Korb, Sicherheitsthermostat, Frittierfett muss separat ausgelassen werden
Acier inoxydable, 1 cuve 4 litres, avec une corbeille, thermostat de sécurité, faire fondre la graisse à frire séparément

Art-Nr./No d'article	Grösse/grandeur	Gewicht/poids	Anschluss/puissance	Preis/prix
8270.90015	22 x 40 x H 31,5 cm	7 kg	230 V / 2,0 kW	282.30

Zubehör/Accessoires

8270.90085	Frittierfettfilter / Filtre pour friteuse	123.50
8270.90086	Ersatzfilter / Filtre de remplacement	76.20



T23



Elektro-Friteuse mit Fettablasshahn
Friteuse électrique avec robinet de vidange

Chromnickelstahl, 1 Becken 8 Liter inkl. 1 Korb, Sicherheitsthermostat, Frittierfett muss separat ausgelassen werden
Acier inoxydable, 1 cuve 8 litres, avec une corbeille, thermostat de sécurité, faire fondre la graisse à frire séparément

Art-Nr./No d'article	Grösse/grandeur	Gewicht/poids	Anschluss/puissance	Preis/prix
8270.90000	29 x 55 x H 41 cm	10 kg	230 V / 3,25 kW	587.00

Zubehör/Accessoires

8270.90085	Frittierfettfilter / Filtre pour friteuse	123.50
8270.90086	Ersatzfilter / Filtre de remplacement	76.20



x2

T23



Elektro-Doppel-Friteuse mit Fettablasshahn
Friteuse électrique double avec robinet de vidange

Chromnickelstahl, 2 Becken à 8 Liter, inkl. 2 Körbe, 2 getrennte Steckdosen erforderlich, Frittierfett muss separat ausgelassen werden
Acier inoxydable, 2 cuves à 8 litres, avec 2 corbeilles, 2 prises de courant sont nécessaires, thermostat de sécurité, faire fondre la graisse à frire séparément

Art-Nr./No d'article	Grösse/grandeur	Gewicht/poids	Anschluss/puissance	Preis/prix
8270.90003	58 x 55 x H 41 cm	22 kg	2 x 230 V / 2 x 3,25 kW	939.85

Zubehör/Accessoires

8270.90085	Frittierfettfilter / Filtre pour friteuse	123.50
8270.90086	Ersatzfilter / Filtre de remplacement	76.20

KOCHAPPARATE / APPAREILS DE CUISSON



T25



«Professional»
Elektro-Fritteuse mit Fettablasshahn
Friteuse électrique avec vanne de vidange

Gehäuse, Deckel und Schaltkasten aus Chromnickelstahl, 1 Becken: 10 Liter inklusive 1 Korb, Korbmass: 30 x 24 x H 12 cm, Heizelemente aus Edelstahl, Kaltzone, Sicherheitsthermostat (Überhitzungsschutz)

Châssis, couvercle et combinateur en acier nickel-chrome, 1 bac : 10 litres, 1 corbeille inclus, mesures de corbeille : 30 x 24 x H 12 cm, éléments chauffants en inox, zone froide, thermostat de sécurité (protection thermique)

Art-Nr./No d'article	Grösse/grandeur	Gewicht/poids	Anschluss/puissance	Preis/prix
8270.90115	39 x 45 x H 37,5 cm	11,2 kg	400 V / 8,1 kW	1093.85

Ersatzteile/Pièces de rechange

8270.90118 Ersatzkorb klein (Für 1 Becken werden 2 Körbe benötigt) **76.20**
Corbeille de rechange petit (2 corbeilles pour 1 bac)

15 x 24 x H 12 cm / 1,0 kg
8270.90119 Ersatzkorb gross **96.20**
Corbeille de rechange grand
30 x 24 x H 12 cm / 1,5 kg



x2

T25



«Professional II»
Elektro-Fritteuse mit Fettablasshahn
Friteuse électrique avec vanne de vidange

Mit den 2 grossen Körben ist die Doppel-Fritteuse vor allem in Stosszeiten für den professionellen Einsatz hervorragend geeignet, Gehäuse, Deckel und Schaltkasten aus Chromnickelstahl, 2 Becken: 10 Liter, 2 Körbe, Korbmass: 30 x 24 x H 12 cm, Heizelemente aus Edelstahl, Kaltzone, Sicherheitsthermostat (Überhitzungsschutz)

La double-friteuse est bien adapté aux heures de pointe avec 2 grandes corbeilles pour une utilisation professionnelle, châssis, couvercle et combinateur en acier nickel-chrome, 2 bacs: 10 litres, 2 corbeilles, Mesure de corbeilles: 30 x 24 x H 12 cm, éléments chauffants en inox, zone froide, thermostat de sécurité (protection thermique)

Art-Nr./No d'article	Grösse/grandeur	Gewicht/poids	Anschluss/puissance	Preis/prix
8270.90116	78 x 45 x H 37,5 cm	22 kg	400 V / 16,2 kW	1823.50

Ersatzteile/Pièces de rechange

8270.90118 Ersatzkorb klein (Für 1 Becken werden 2 Körbe benötigt) **76.20**
Corbeille de rechange petit (2 corbeilles pour 1 bac)

15 x 24 x H 12 cm / 1,0 kg
8270.90119 Ersatzkorb gross **96.20**
Corbeille de rechange grand
30 x 24 x H 12 cm / 1,5 kg



T25



MADE IN SWITZERLAND

«V200»
Elektro-Fritteuse
Friteuse électrique

Ölbad 7-9 Liter, 19-23 kg Pommes Frites/Std.
Cuve 7-9 litres, 19-23 kg frites/heures.

Tiefgezogenes Edelstahl-Ölbad aus einem Stück, ohne Schweissnähte, leicht zum Reinigen. Hochklappbare Heizkörper. Entleerungs-Konus mit Kaltöl-Zone zum Entfernen der Rückstände, automatisches Absenken der Öltemperatur im «Stand-by-Modus». Leicht zu bedienender Kugelhahn mit Sicherheit. Energie-Ersparnis und mehr Leistungsfähigkeit dank Vorrichtung zum Programmieren der Leistung. Staufach für Deckel in der Tür.

Cuve inox emboutie d'une pièce sans soudures, facilitant le nettoyage. Corps de chauffe pivotant vers le haut améliorant l'accès à la cuve lors de l'entretien. Cône de vidange avec zone froide de récupération des déchets, baisse automatique de la température de l'huile en «Stand by». Robinet à bille avec sécurité, facile à manipuler. Economie d'énergie et gain de productivité grâce au système de puissance programmée. Espace de rangement pour le couvercle dans la porte.

Art-Nr./No d'article	Grösse/grandeur	Gewicht/poids	Anschluss/puissance	Preis/prix
8006.96202	20 x 58 x H 85-90 cm	32 kg	400 V / 7,2 kW	3917.40

Weitere Modelle auf Anfrage.
Autres modèles sur demande.



ANSCHLUSS BAUSEITIG!
CONNEXION
MONTÉE SUR SITE!



T23



EINFACHE REINIGUNG
NETTOYAGE FACILE

Induktions-Friteuse mit Fettablasshahn
Friteuse induction avec robinet de vidange

Edelstahl, Heizelement: Induktionsspule, 1 Becken 8 Liter inkl. 1 Korb, Temperaturbereich 60° C bis 190° C, Sicherheitsthermostat, Kontrolleuchten, inklusive 1 Deckel und 1 Lochblech

Acier inoxydable, élément chauffant: bobine d'induction, 1 bac de 8 litres avec 1 panier, plage de températures de 60 °C à 190 °C, thermostat de sécurité, voyants lumineux, avec 1 couvercle et 1 plaque perforée

Art.-Nr./No d'article	Grösse/grandeur	Gewicht/poids	Anschluss/puissance	Preis/prix
8270.90950	29 x 48 x H 51,5 cm	10,4 kg	230 V / 3,5 kW	869.95

Ersatzteile/Pièces de rechange

8270.90951	Ersatzkorb Corbeille de rechange	81.15
-------------------	-------------------------------------	--------------



x2

T23



EINFACHE REINIGUNG
NETTOYAGE FACILE

Induktions-Friteuse mit Fettablasshahn
Friteuse induction avec robinet de vidange

Edelstahl, Heizelement: Induktionsspule, 2 Becken 8 Liter inkl. 2 Körbe, Temperaturbereich 60° C bis 190° C, Sicherheitsthermostat, Kontrolleuchten, inklusive 2 Deckel und 2 Lochbleche

Acier inoxydable, élément chauffant: bobine d'induction, 2 bacs de 8 litres avec 2 paniers, plage de températures de 60 °C à 190 °C, thermostat de sécurité, voyants lumineux, avec 2 couvercles et 2 plaques perforées

Art.-Nr./No d'article	Grösse/grandeur	Gewicht/poids	Anschluss/puissance	Preis/prix
8270.90960	58 x 48 x H 51,5 cm	19 kg	2 x 230 V / 3,5 kW	1694.05

Ersatzteile/Pièces de rechange

8270.90951	Ersatzkorb Corbeille de rechange	81.15
-------------------	-------------------------------------	--------------

Frittierfettfilter
Filtre pour friteuse

Der Frittierfettfilter aus Spezialgewebe entfernt auch die kleinsten Brat- und Backreste zuverlässig. Einsetzbar bei Temperaturen bis 190° C.

Le filtre à graisse de friture est réalisé en tissu spécial qui retient les petits restes de cuisson et de friture. Utilisable à une température de 190°.



Art.-Nr./No d'article	Grösse/grandeur	Preis/prix
8270.90085	18,1 x 60 x H 15,5 cm	123.50

Ersatzteile/Pièces de rechange

8270.90086	Ersatzfilter Filtre de remplacement	76.20
-------------------	--	--------------

KOCHAPPARATE / APPAREILS DE CUISSON



T13

Reiskocher
Cuiseur à riz

Für 2-10 Personen. Gehäuse aus Inox 18/10, Innentopf antihafbeschichtet
Pour 2 à 10 personnes. Corps en inox 18/10, corps intérieur avec revêtement anti-adhésif

Gerät ist nicht für den dauerhaften gewerblichen Einsatz geeignet.
 Cet appareil ne se prête pas à un usage professionnel prolongé.

Art-Nr./No d'article	Grösse/grandeur	Inhalt/capacité	Anschluss/puissance	Preis/prix
8270.90090	Ø 28,5 x H 28,5 cm	1,8 L	230 V / 0,7 kW	102.10



T13

Reiskocher
Cuiseur à riz

Für 25-40 Personen. Extra grosse Griffe, Innentopf mit hoher Qualität, hitzebeständig, Rundum-Warmhaltefunktion, Gehäuse aus Inox 18/10, Innentopf antihafbeschichtet

Pour 25 à 40 personnes. Poignées extra-larges, corps intérieur de haute qualité, résistant à la chaleur, isolation circulaire, Corps en inox 18/10, corps intérieur avec revêtement anti-adhésif

Art-Nr./No d'article	Grösse/grandeur	Inhalt/capacité	Anschluss/puissance	Preis/prix
8270.90047	Ø 38,4 x H 37,5 cm	8 L	230 V / 1,95 kW	435.25



T13

WMF «BuenoPro»
Toaster
Toaster

Toaster aus mattem Edelstahl mit Doppelschlitze und Brötchenaufsatz, 6 Bräunungsstufen, 870 Watt Leistung, mit herausnehmbarer Krümelschubblende, inkl. Auftau-Funktion und Nachtoast-Funktion

Grille-pain en acier inoxydable mat avec double fente et support à petits pains, 6 zones de brunissage, puissance 870 watts, avec tiroir ramassemiettes amovible, y compris fonction de décongélation et fonction toast de nuit

Art-Nr./No d'article	Grösse/grandeur	Gewicht/poids	Anschluss/puissance	Preis/prix
04.1413.0011	29,9 x 20,3 x H 18,7 cm	1,7 kg	230 V / 870w	81.15



T13

DUALIT
Toaster
Toaster

Material: Edelstahl / Aluminium, Handgefertigt, Energieeffizient durch Toast-Schlitzwahlwähler, Timer, Kontrollleuchte, Krümellade
 Matériel: inox / aluminium, Travail manuel, Déficient en énergie par sélecteur d'échancrure, Minuterie, Lumière de contrôle, Ramasse-miettes

Art-Nr./No d'article	Grösse/grandeur	Gewicht/poids	Anschluss/puissance	Preis/prix
8270.90133	22 x 36 x H 21 cm	4,9 kg	230 V / 2,3 kW	623.50

**STETIGE REINIGUNG
 UNERLÄSSLICH!
 NETTOYAGE RÉGULIER
 PRIMORDIAL!**



T13



STETIGE REINIGUNG
UNERLÄSSLICH!
NETTOYAGE RÉGULIER
PRIMORDAL!

Eierkocher
Cuiseur à œufs

Eierkocher mit 6 separaten Einsätzen, so dass für jeden Gast die gewünschte Kochzeit gewählt werden kann. Edelstahlbehälter mit eingebautem Widerstand und Temperaturbegrenzer für einen absolut sicheren Kochvorgang. Thermostatregler, Edelstahldeckel zum Verstauen.

Cuiseur à œufs équipé de 6 paniers individuels permettant à chaque convive de préparer l'œuf à la cuisson souhaitée. Bac inox avec résistance incorporée et limiteur de température pour une cuisson en toute sécurité. Thermostat de régulation, livré avec couvercle inox pour le rangement.

Art.-Nr./No d'article	Grösse/grandeur	Gewicht/poids	Anschluss/puissance	Preis/prix
8006.96235	43 x 21,5 x H 25,5 cm	4,5 kg	230 V / 1,2 kW	694.00

Ersatzteile/Pièces de rechange

8006.96236	Ersatzkorbli (1 Stk.) Corbeille de rechange (1 pce.)			23.40
------------	---	--	--	-------



T13



Mikrowellengerät
Four micro-ondes

Inhalt 28 Liter, mit Drehteller 31,4 cm, 6 Leistungspegel, Enteisungsfunktion, mechanische Zeituhr bis 30 Minuten, Innenbekleidung Epoxy Weiss, aussen grau verchromt

Capacité 28 litres, avec plateau tournant, 6 niveaux de puissance, fonction décongélation, minuterie mécanique jusqu'à 30 minutes, cavité époxy blanc, carrosserie gris chromé

Art.-Nr./No d'article	Grösse/grandeur	Anschluss/puissance	Preis/prix
8006.96225	52,5 x 43 x H 30,5 cm	220 V / 1,4 kW	435.25



T23



Mikrowellengerät
Four micro-ondes

Mikrowelle mit 2 leistungsstarken Magnetrons für gleichmässige Ergebnisse, Gehäuse und Garraum aus Edelstahl, Fassungsvermögen 26 Liter, Geeignet für GN 2/3, 5 Leistungsstufen (185 W, 370 W, 925 W, 1295 W und 1850 W), Digitale Steuerung, +20-Sekunden-Taste, 2 Auftaufunktionen

Micro-ondes avec 2 magnétrons puissants pour des résultats homogènes, Boîtier et espace de cuisson en acier inoxydable, Capacité 26 litres, Convient pour GN 2/3, 5 niveaux de puissance (185 W, 370 W, 925 W, 1295 W et 1850 W), Commande numérique, Touche +20 secondes, 2 fonctions de décongélation

Art.-Nr./No d'article	Grösse/grandeur	Anschluss/puissance	Preis/prix
8270.90088	46,4 x 55,7 x H 36,8 cm	230 V / 2,6 kW	1717.60

WARMHALTEAPPARATE / APPAREILS DE CHAUFFANTS



T13



Bain Marie mit Wasserablaufhahn Bain Marie avec robinet de recharge

Inox 18/10, für 150 mm oder 200 mm tiefe GN 1/1 Behälter und alle entsprechenden Kombinationen

Inox 18/10, pour bac GN 1/1 de 150 mm ou 200 mm de profondeur et variantes GN

Art-Nr./No d'article	Grösse/grandeur	Tiefe/profondeur	Anschluss/puissance	Preis/prix
8270.00010	34,0 x 59,0 x H 24,0 cm	150 mm	230 V / 1,2 kW	324.65
8270.00011	35,4 x 61,5 x H 29,5 cm	250 mm	230 V / 1,2 kW	435.25



T13



HUGENTOBLER «Hold-o-mat®411» Warmhalte- & Niedertemperatur-Gargerät Appareil de maintien au chaud et cuisson basse température

Gerät zum Warmhalten bzw. zum Niedertemperatur-Garen (Cook&Hold), Gehäuse aus hochwertiger Chromnickelstahl, ausklappbare Tragegriffe für einfachen Transport, Türanschlag rechts (leicht zu wechseln), Aufnahme für max. 4 x GN 1/1 - 65 oder 2 x GN 1/1 - 100, raffiniertes Entfeuchtungssystem über alle Einschübe, vorbereitet für optionale Kerntemperatur-Sonde und Programme, OLED-Display zeigt auf einen Blick die Soll-, Ist- und Kerntemperatur und ermöglicht einfaches Programmieren, Temperaturgenauigkeit +/-1°C

Appareil de maintien au chaud et cuisson basse température (Cook&Hold), corps en acier inoxydable haute qualité, poignées rabattables pour un transport facilité, butée de porte droite (facilement interchangeable), support pour max. 4 GN 1/1 - 65 ou 2 GN 1/1 - 100, système de déshumidification ingénieux sur tous les rails de cuisson, préparé pour sonde de température à cœur et programmes en option, écran OLED affichant en un clin d'œil la température de consigne, réelle et à cœur et facilitant la programmation, précision de température de +/-1°C

Art-Nr./No d'article	Grösse/grandeur	Anschluss/puissance	Preis/prix
8270.90800	41,5 x 67,5 x H 42,3 cm	230 V / 1,5 kW	4458.55

Zubehör/Accessoires

8270.90801	Kerntemperatur-Sonde zu Hold-o-mat 411 Sonde de température à cœur pour Hold-o-mat 411	446.80
------------	---	--------



T13



**«Caldomat»
Niedrigtemperatur- und Warmhaltegerät
Appareil chauffant – cuisson à point**

Vollständig aus Inox, tragbar, stapelbar, überall einsatzbereit, robuste Tür mit Magnetverschluss, links/rechts Türbandung, Garraum mit abgerundeten Ecken, digitale Bedieneinheit, COOK-Funktion max. 120°C für Langzeitgaren, HOLD-Funktion zum gradgenauen Warmhalten, Kerntemperatur serienmässig, Abstand zwischen den Blechen: 67 mm, Kapazität 3 x GN 1/1
En inox, portable, empilable, opérationnel partout, porte robuste avec fermeture aimant, gauche/droite cadre de porte, espace cuisson à point avec coins arrondis, contrôle de manipulation digital, fonction COOK max. 120° pour cuisson à point longue durée, fonction HOLD pour maintenir la température, contrôle température à cœur de série, distance entre les plaques: 67 mm, capacité: 3 x GN 1/1

Art.-Nr./No d'article	Grösse/grandeur	Anschluss/puissance	Preis/prix
8270.90310	43,6 x 64,5 x H 40,9 cm	230 V / 0,76 kW	2586.85



T13



**«Caldomat»
Niedrigtemperatur- und Warmhaltegerät
Appareil chauffant – cuisson à point**

Vollständig aus Inox, tragbar, stapelbar, überall einsatzbereit, robuste Tür mit Magnetverschluss, links/rechts Türbandung, Garraum mit abgerundeten Ecken, digitale Bedieneinheit, COOK-Funktion max. 120°C für Langzeitgaren, HOLD-Funktion zum gradgenauen Warmhalten, Kerntemperatur serienmässig, Abstand zwischen den Blechen: 75 mm, Kapazität 5 x GN 1/1
En inox, portable, empilable, opérationnel partout, porte robuste avec fermeture aimant, gauche/droite cadre de porte, espace cuisson à point avec coins arrondis, contrôle de manipulation digital, fonction COOK max. 120° pour cuisson à point longue durée, fonction HOLD pour maintenir la température, contrôle température à cœur de série, distance entre les plaques: 75 mm, capacité: 5 x GN 1/1

Art.-Nr./No d'article	Grösse/grandeur	Gewicht/poids	Anschluss/puissance	Preis/prix
8270.90311	44,5 x 63,3 x H 57,1 cm	31 kg	230 V / 1,0 kW	3729.20



T13



**CADDIE «Hot Box»
Wärmebox
Cuisson chauffant**

Die elektrische Wärmebox HOT BOX (500W) ist komplett aus Edelstahl gefertigt und hat isolierte Wände. Mit Analog-Thermostat (30°- 90°C). Tür- und Tragegriffe aus Kunststoff für eine sichere Handhabung, 2 höhenverstellbare Gittereinlegeböden, Türen mit Magnet-Verschluss, für Teller bis Ø 32 cm geeignet, passend für die Roomservice-Tische Easy, Flip Top und Compact XS
La HOTBOX électrique dispose d'une structure et d'une porte complètement isolées en inox. Un thermostat permet de régler la température (30°-90°C). Poignées en matériau plastique 1 sur la partie supérieure, 1 sur la partie frontale et 1 sur chaque côté, 2 étagères ajustables en fil d'acier, porte aimantée, assiettes jusqu'à Ø32 cm, compatible avec les tables room service Easy, Flip top et Compact XS

Art.-Nr./No d'article	Grösse/grandeur	Gewicht/poids	Anschluss/puissance	Preis/prix
8490.00055	38 x 40,5 x H 51,2 cm	18 kg	220 V / 0,5 kW	1352.90

WARMHALTEAPPARATE / APPAREILS DE CHAUFFANTS



ANSCHLUSS BAUSEITIG!
CONNEXION
MONTÉE SUR SITE!



Infrarot-Wärme-Strahler Lampe chauffante infrarouge

Stahl lackiert, mit Pendelhubsystem für ein bedarfgerichtetes Warmhalten der Speisen, zur Deckenmontage, Kabellänge 65 cm bis 160 cm, belüfteter Stahlreflektor, inklusive Infrarotlampe klar

Acier laqué, avec système à mouvement pendulaire pour maintenir correctement au chaud les plats, pour montage au plafond, longueur de câble 65 cm à 160 cm, réflecteur en acier ventilé, avec lampe infrarouge claire

Art-Nr./No d'article	Grösse/grandeur	Gewicht/poids	Anschluss/puissance	Preis/prix
8270.90989	Ø 24 cm x H 26,5 cm	1,04 kg	230 V / 0,25 kW	254.05
8270.90990	Ø 24 cm x H 26,5 cm	1,04 kg	230 V / 0,25 kW	218.80
8270.90991	Ø 24 cm x H 26,5 cm	1,04 kg	230 V / 0,25 kW	218.50
8270.90992	Ø 24 cm x H 26,5 cm	1,04 kg	230 V / 0,25 kW	254.05
8270.90993	Ø 24 cm x H 26,5 cm	1,04 kg	230 V / 0,25 kW	254.05

Zubehör/Accessoires

8270.90994	Glühbirne 250 W klar			31.70
	Ampoule 250 W transparent			
8270.90995	Glühbirne 250 W rot			34.05
	Ampoule 250 W rouge			



T13



Infrarot-Wärmebrücke Pont à infrarouge

Lieferung ohne Füße, Achtung: Bei Verwendung mit Universalfuss muss total 13 cm dazugerechnet werden für den Platzbedarf.

Livré sans pieds universels

Art-Nr./No d'article	Länge/longueur	Gewicht/poids	Anschluss/puissance	Preis/prix
8270.90141	76 cm	4 kg	230 V / 0,65 kW	411.70
8270.90142	92 cm	5 kg	230 V / 0,80 kW	458.60
8270.90143	107 cm	5 kg	230 V / 0,95 kW	493.85
8270.90144	122 cm	5 kg	230 V / 1,10 kW	587.00
8270.90145	137 cm	6 kg	230 V / 1,25 kW	552.90
8270.90146	183 cm	7 kg	230 V / 1,73 kW	764.65

Zubehör/Accessoires

8270.90147	Universalfuss (Paar)/Pieds universels (paire) H 37 cm			152.90
------------	---	--	--	--------



T13

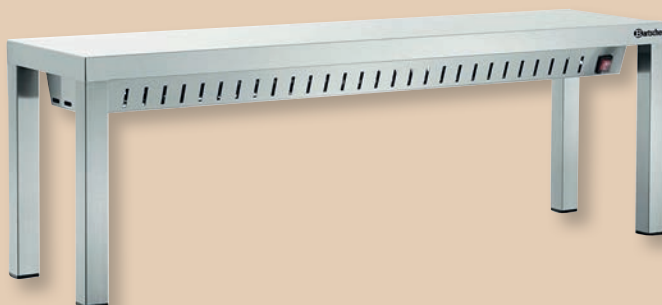

Infrarot-Wärmebrücke Pont à infrarouge

Edelstahl, Stellfüsse aus Vierkantrohr 25 x 25 mm

Acier inoxydable, pieds ajustables en tube carré 25 x 25 mm

Art-Nr./No d'article	Grösse/grandeur	Gewicht/poids	Anschluss/puissance	Preis/prix
8270.90970	80 x 30 x 40 cm	8 kg	230 V / 0,2 kW	1046.95
8270.90971	100 x 30 x 40 cm	9 kg	230 V / 0,4 kW	1173.95
8270.90972	120 x 30 x 40 cm	11 kg	230 V / 0,6 kW	1352.90
8270.90973	140 x 30 x 40 cm	12 kg	230 V / 0,6 kW	1409.80
8270.90974	160 x 30 x 40 cm	14 kg	230 V / 0,6 kW	1528.20



T13



Schneidplatte mit Heizung
Plaque de découpe chauffante

Warmhalten durch direktes Auflegen auf die Schneidplatte, mit glatter Platte, inkl. Hauchschutz, Ober- und Unterhitze
Maintien au chaud par pose directe sur plaque aluminium, avec plaque standard, avec pare haleine, éléments de cuisson supérieur et inférieur

Art-Nr./No d'article	Grösse/grandeur	Gewicht/poids	Anschluss/puissance	Preis/prix
8006.97015	59 x 41,5 x H 47 cm	12 kg	230 V / 1,1 kW	2729.15



T13



Schneidplatte mit Heizung
Plaque de découpe chauffante

Warmhalten durch direktes Auflegen auf die Schneidplatte, mit eingekerbter Platte, inkl. Hauchschutz, Ober- und Unterhitze
Maintien au chaud par pose directe sur plaque aluminium, avec plaque à picots, avec pare haleine, éléments de cuisson supérieur et inférieur

Art-Nr./No d'article	Grösse/grandeur	Gewicht/poids	Anschluss/puissance	Preis/prix
8006.97016	59 x 41,5 x H 47 cm	12 kg	230 V / 1,1 kW	2939.75



T13



Infrarot-Wärmebrücke GN 1/1
Pont thermique à infrarouge GN 1/1

CNS, inklusive GN-Behälter und Lochblech
inox, compris: 1 GN et un bac perforé

Art-Nr./No d'article	Grösse/grandeur	Gewicht/poids	Anschluss/puissance	Preis/prix
8270.90140	33 x 56 x H 50 cm	8 kg	230 V / 1 kW	498.85

WARMHALTEAPPARATE / APPAREILS DE CHAUFFANTS



T13

Buffet-Wärmelampe
Lampe chauffante de buffet

Fussplatte aus inox, Lampenschirm, flexible Arme verchromt. Fussplatte mit eingebautem Ein-/Ausschalter und Anschlusskabel. Lieferung inklusive Glühbirne. *Plaque de base en inox, abat-jour, bras flexible chromé. Plaque de base avec interrupteur marche/arrêt intégré et câble d'alimentation. Livraison inclus ampoule.*

Art-Nr./No d'article	Grösse/grandeur	Anschluss/puissance	Preis/prix
8270.90250	20 x 20 x H70 cm	230V / 250W	822.30

Zubehör/Accessoires

8270.90994	Glühbirne 250 W klar Ampoule 250 W transparent		31.70
-------------------	---	--	--------------



T13

«BiTherm»
Buffet-Wärmelampe
Lampe chauffante de buffet

Doppel-Buffer-Wärmelampe. Zwei Schalter ermöglichen das getrennte Ein- und Ausschalten. Lieferung inklusive Glühbirne. *Lampe chauffante de buffet double. Les deux interrupteurs permettent d'allumer et d'éteindre séparément.*

Art-Nr./No d'article	Grösse/grandeur	Anschluss/puissance	Preis/prix
8270.90251	20 x 20 x H70 cm	230V / 500W	1117.60

Zubehör/Accessoires

8270.90994	Glühbirne 250 W klar Ampoule 250 W transparent		31.70
-------------------	---	--	--------------



T13

Elektro-Warmhalteplatte für GN 1/1
Plaque chauffante électrique pour GN 1/1

Die Warmhalteplatte besteht aus einem Aluminium Gehäuse, einer Oberfläche aus Glas und ist mit einem Ein/Aus-Schalter sowie einer Kontrolllampe ausgestattet. Es ist eine stufenlose Temperaturregelung möglich, von 30° C bis zur maximalen Oberflächentemperatur von 95° *La plaque électrique se compose d'un boîtier en aluminium, d'une plaque en verre, d'un interrupteur marche/arrêt et d'une lampe-témoin. Contrôle de la température par réglage en continu de 30° jusqu'à maximum 95°.*

Art-Nr./No d'article	Grösse/grandeur	Gewicht/poids	Anschluss/puissance	Preis/prix
8270.90093	GN 1/1	3,45 kg	230 V / 0,2 kW	254.05



T13

Tassenwärmer für 72 Tassen
Chauffe-tasses pour 72 tasses

Edelstahl, Tassentemperatur bis ca. 60 °C, Ablagefläche 25 x 25 cm zum Abstellen von Untertellern, Tassen, etc. *Acier inoxydable, température des tasses jusqu'à 60 °C, surface des plateaux: 25 x 25 cm pour soucoupes, tasses etc.*

Art-Nr./No d'article	Grösse/grandeur	Tassen/tasses	Anschluss/puissance	Preis/prix
8270.90331	32 x 34,5 x H 55 cm / 10,7 kg	72 (< Ø 9 cm)	230 V / 0,14 kW	764.65



T13



**Tellerwärmer
Chauffe-assiettes**

Tischgerät, zum Aufstellen auf einem Arbeitstisch oder Buffet, Edelstahl, mit festem Zwischenboden, 1 Drehlasttür, Temperatur thermostatisch regelbar von 30-80°C.

Appareil de table, à poser sur un plan de travail ou buffet, inox, 1 vitre en verre tournante, température réglable thermostatique de 30-80°C.

Art-Nr./No d'article	Grösse/grandeur	Teller/assiette	Anschluss/puissance	Preis/prix
8270.90320	Ø 46 x H 57,5 cm / 21,6 kg	30-40 (< Ø 32 cm)	230 V / 0,6 kW	1046.95



T13



**Wärmeschrank, 1-türig
Armoire chauffante, 1 porte**

Inox, 1 Bord, Thermostat 0 - 90° C

Inox, avec rayonnement intermédiaire, thermostat de 0 à 90° C

Art-Nr./No d'article	Grösse/grandeur	Teller/assiette	Anschluss/puissance	Preis/prix
8270.90037	40 x 40 x H 55 cm	25-30 (< Ø 32 cm)	230 V / 0,40 kW	635.25
8270.90038	45 x 45 x H 85,5 cm	55-60 (< Ø 32 cm)	230 V / 0,75 kW	822.30



T13



**Wärmeschrank, 2-türig
Armoire chauffante, 2 portes**

Inox, 1 Bord, Thermostat 0 - 90° C, Gewicht 34 kg

Inox, avec rayonnement intermédiaire, thermostat de 0 à 90° C, poids 34 kg

Art-Nr./No d'article	Grösse/grandeur	Teller/assiette	Anschluss/puissance	Preis/prix
8270.90039	75 x 45 x H 85,5 cm	110-120 (< Ø 32 cm)	230 V / 1,5 kW	1173.95

WARMHALTEAPPARATE / APPAREILS DE CHAUFFANTS



T13



**BEST
SELLER**

Tellerwärmer Chauffe-assiettes

Edelstahl, 3 Einlegeböden auf Schienen zum Herausziehen, manuelle Temperatureinstellung, ermöglicht das Aufwärmen von 60 Tellern gleichzeitig, 4 Rollen mit Feststellbremse, Ventilator sorgt für eine gleichmässige Wärmeverteilung
Acier inoxydable, 3 tablettes sur rails à tirer, réglage manuel de la température, permet de réchauffer 60 assiettes en même temps, 4 roulettes avec frein de blocage, ventilateur qui assure une répartition égale de la chaleur

Art-Nr./No d'article	Grösse/grandeur	Teller/assiette	Anschluss/puissance	Preis/prix
8270.35020	60 x 35 x H 77 cm / 14 kg	60 (< Ø 28 cm)	230 V / 0,8 kW	846.95



T13



HUPFER

Tellerstapler, 1 Schacht, verstellbar, statisch beheizt Chariot à assiettes, 1 conduit, réglable, chauffant statiquement

Aus Inox. Viele Details wie z.B. die einfache Einstellung auf alle gängigen Tellergrössen, die unkomplizierte Bedienung, die hohen Tellerstapel und die stufenlose Temperaturregelung verdeutlichen den hohen Anwendernutzen.

En inox. Beaucoup de détails, comme p.ex. le réglage simple des guides en fonction du diamètre des assiettes, l'utilisation facile, les piles d'assiettes hautes et le réglage précis de température clarifient la grande utilité.

Art-Nr./No d'article	Grösse/grandeur	Teller/assiettes	Preis/prix
0162808	46 x 61 x H 90 cm	Ø 19-26, max. 83 pcs	2493.85
0162809	53 x 71 x H 90 cm	Ø 27-33, max. 61 pcs	2586.85



T13



HUPFER

Tellerstapler, 2 Schacht, verstellbar, statisch beheizt Chariot à assiettes, 2 conduit, réglable, chauffant statiquement

Aus Inox. Viele Details wie z.B. die einfache Einstellung auf alle gängigen Tellergrössen, die unkomplizierte Bedienung, die hohen Tellerstapel und die stufenlose Temperaturregelung verdeutlichen den hohen Anwendernutzen.

En inox. Beaucoup de détails, comme p.ex. le réglage simple des guides en fonction du diamètre des assiettes, l'utilisation facile, les piles d'assiettes hautes et le réglage précis de température clarifient la grande utilité.

Art-Nr./No d'article	Grösse/grandeur	Teller/assiettes	Preis/prix
0162810	46 x 93,5 x H 90 cm	Ø 19-26, max. 166 pcs	2822.10
0162811	53 x 105,5 x H 90 cm	Ø 27-33, max. 122 pcs	3057.40



T13



**Suppentopf
Chaudron à soupe**

Aussentopf aus Polypropylen, herausnehmbarer Einsatz aus Inox, elektrisch, mit Wasserbad, inkl. Suppenlöffel, integrierter Tragering für den Innenbehälter, Deckel mit hitzeisolierendem Griff, Temperaturregelung 80°C (± 10°C)

Corps extérieur en polypropylène, récipient à soupe inox amovible, bain-marie électrique, louche à soupe incl., support circulaire inox, thermostat maxi 80°C (± 10°C)

Art.-Nr./No d'article	Grösse/grandeur	Inhalt/capacité	Anschluss/puissance	Preis/prix
8582.11901	Ø 38 x H 36,5 cm	10 L	230 V / 0,5 kW	234.05



T13



**«Gourmet»
Suppentopf
Chaudron**

Aussentopf aus Kunststoff, herausnehmbarer Einsatz aus Inox 18/10, Regelthermostat von 50° - 95° C, hitzeisolierter Griff

Corps extérieur en matière synthétique, cuve intérieure inox retirable réglable par thermostat de 50 à 90°C, poignées isolantes

Art.-Nr./No d'article	Grösse/grandeur	Inhalt/capacité	Anschluss/puissance	Preis/prix
8270.90045	Ø 38,1 x H 36,5 cm	10 L	220 - 240 V / 0,4 kW	178.80

Ersatzteile/Pièces de rechange

8270.90049	Ersatzdeckel Couvercle de rechange			62.30
-------------------	---------------------------------------	--	--	--------------



T13



**«De Luxe»
Suppentopf
Chaudron**

Aussentopf aus Inox 18/10, herausnehmbarer Einsatz aus Inox 18/10, Regelthermostat von 50° - 95° C, hitzeisolierter Griff, inkl. 8 magnetisch haftender Suppenbeschriftungen

Corps extérieur en inox 18/10, cuve intérieure inox 18/10, réglable par thermostat de 50 à 90°C, poignées isolantes, avec 8 inscriptions magnétiques pour potage

Art.-Nr./No d'article	Grösse/grandeur	Inhalt/capacité	Anschluss/puissance	Preis/prix
8270.90046	Ø 33 x H 36 cm	9,5 L	230 V / 0,4 kW	254.05

HEISSGETRÄNKE / BOISSONS CHAUDES



T13



**STETIGE REINIGUNG
UNERLÄSSLICH!
NETTOYAGE RÉGULIER
PRIMORDAL!**

Glühwein- und Einkochautomat Stérilisateur automatique et distributeur pour vin chaud

mit Ablaufhahn zum Abfüllen von Getränken, Temperaturregler mit Präzisionsthermostat, stufenlose Temperaturwahl mit Entsafterschaltung, säurefeste 2-fach Emaillierung, leichte Reinigung, geschlossener Topfboden, wärmeisolierte Griffe, Einlegerost, Kabelaufwicklung, Überhitzungsschutz, Kontrolllampe
robinet de vidange pour mettre des boissons en bocaux en pratique, régulateur température avec thermostat de précision, température ajustable en continu, réglage «faire de jus», émail antiacide à double couche, nettoyage facile, fond fermé, poignées isolées, grille enlevable, dépôt de câble, protection contre la surchauffe, lampe de contrôle

Art-Nr./No d'article Anschluss/dimension Inhalt/capacité
420040100 230 V / 1,8 kW 27 L

Preis/prix
138.60



T23



Getränkewärmer Chauffe-boissons

Edelstahl, Bain-Marie-System, No-drip Hahn, Synthetische Handgriffe, Thermostatische Einstellung, Temperatur einstellbar bis ca. 85° C, Einfach zu reinigen, Achtung Gehäuse wird heiss
Acier inoxydable, système de bain-marie, robinet stop-goutte, poignées synthétiques, réglage thermostatique, température réglable jusqu'à env. 85 °C, facile à nettoyer, avertissement boîtier chaud

Art-Nr./No d'article	Grösse/grandeur	Inhalt/capacité	Anschluss/puissance	Preis/prix
8270.35030	Ø 42,8 x H 20,6 cm	5 l	230 V / 3,2 kW	1352.90
8270.35031	Ø 42,4 x H 27,4 cm	10 l	230 V / 3,2 kW	2069.80
8270.35032	Ø 50,1 x H 34,6 cm	20 l	230 V / 3,2 kW	2493.85

**ULTRAROBUST
DURETÉ EXTRAORDINAIRE**



T13



**«MultiTherm»
Heissgetränke-Kessel
Pot à boissons chaudes**

Inox, mit Ablasshahn, geeignet für Glühwein, Jägertee oder Heisswasser für Tee usw., nicht für Milch geeignet
Inox, avec robinet de vidagne, pour vin chaud, eau chaude pour thé etc., ne convient pas pour lait

Art-Nr./No d'article	Grösse/grandeur	Inhalt/capacité	Anschluss/puissance	Preis/prix
8270.90048	Ø 27 x H 61 cm	20 L	230 V / 2,0 kW	351.70

STETIGE REINIGUNG
UNERLÄSSLICH!
NETTOYAGE RÉGULIER
PRIMORDAL!



T13



**«Pro 60T»
Rundfilter-Kaffeemaschine
Machine à café filtre**

Inox, Füllstandsanzeiger, Mindest-Auffüllmenge 4,5 Liter (30 Tassen), 2 getrennte Heizsysteme für Brüh- und Warmhaltefunktion, Lieferung ohne Filterpapier
Inox, indicateur de niveau, production minimale 4,5 litres (30 tasses), 2 zones de chauffe séparées, livré sans papiers filtres

Art-Nr./No d'article	Grösse/grandeur	Inhalt/capacité	Anschluss/puissance	Preis/prix
8270.90050	Ø 22 x H 54,5 cm	9 L	230 V / 1,52 kW	282.30

Zubehör/Accessoires	Preis/prix
8270.90051 Rundfilterpapier 1000 Stk. Papier-filtre rond 1000 pcs.	70.55

STETIGE REINIGUNG
UNERLÄSSLICH!
NETTOYAGE RÉGULIER
PRIMORDAL!



T13



**Samovar
Samovar**

Edelstahl und Kunststoff, mit Tragegriff, Lieferung inklusive Teekanne aus Steingut (Inhalt 0,8 L) und Teesieb
Acier inoxydable et matière synthétique avec poignées de transport, théière de 0,8 L (grès) et passoire à thé sont compris dans la livraison

Art-Nr./No d'article	Grösse/grandeur	Anschluss/puissance	Preis/prix
8270.90616	3,2 L / 27 x 27,5 x H 49,5 cm	230 V / 2,0 kW	191.70

STETIGE REINIGUNG
UNERLÄSSLICH!
NETTOYAGE RÉGULIER
PRIMORDAL!

HEISSGETRÄNKE / BOISSONS CHAUDES



T13

**«Contessa 1000»
Kaffeemaschine
Machine à café filtre**

Chromnickelstahl, 2 Warmhalteplatten, 1 Acrylkanne mit Edelstahlboden, Inhalt: ca. 1,6 Liter, Stundenkapazität: 16 Liter, Aufbrühzeit: pro Kanne ca. 6 Minuten, Mindestaufbrühmenge: 1/2 Kanne
Zum Lieferumfang gehört nur eine Kaffeekanne!

Acier inoxydable, 2 plaques chauffantes, 1 cafetière en acrylique avec fond inox, contenance : env. 1,6 litre, production horaire : 16 litres, temps de préparation : par cafetière env. 6 minutes, quantité minimale par préparation : 1/2 cafetière
Une cafetière chauffante est comprise dans la fourniture!

Art-Nr./No d'article	Grösse/grandeur	Gewicht/poids	Anschluss/puissance	Preis/prix
8270.90150	21,5 x 38,5 x H 46 cm	6,5 kg	230 V / 2,0 kW	435.25

Zubehör/Accessoires

8270.90151	Korbfilterpapier 1000 Stk. Papier-filtre 1000 pcs.			42.30
-------------------	---	--	--	--------------

**Glaskanne für Kaffeemaschinen
Cafetière en verre**

Universal-Ersatzkanne passend zu allen gängigen Maschinen und Warmhalteplatten, Inhalt je Kanne ca. 1,7 Liter, Griff und Ausguss schwarz

Cafetière en verre universelle adaptée pour presque toutes les machines à café et plaques chauffantes courantes, contenance : chacune 1,7 litre, poignée et bec verseur noirs

Art-Nr./No d'article	Grösse/grandeur	Gewicht/poids	Preis/prix
8270.90161	Ø 15 x H 17,5 cm	0,4 kg	31.70



T13

**KRUPS «Essenza Mini»
Nespresso-Kaffeemaschine
Machine à café Nespresso**

Nespresso Kaffemaschine aus Kunststoff, Schwarz, 0,6 Liter Wassertank, 1310 Watt Leistung, für Lungo und Espresso, mit Kapselbehälter für 6 Kapseln, automatische Ausschaltung nach 10 Minuten

Machine à café Nespresso en plastique, noir, réservoir d'eau de 0,6 litre, puissance de 1310 watts, pour lungo et espresso, avec réservoir à capsules pour 6 capsules, arrêt automatique après 10 minutes

Art-Nr./No d'article	Grösse/grandeur	Anschluss/puissance	Preis/prix
58.4615.2069	33 x 8,4 x H 20,4 cm	220 V / 1,26 kW	99.75



T13



**WMF «Lono»
Wasserkocher doppelwandig
Bouilloire double paroi**

Wasserkocher mit doppelwandigem Gehäuse aus Cromargan Edelstahl, 2'400 Watt Leistung, mit Safety Touch, separate Basis mit Kabelaufwicklung, Trockenlauf- und Überhitzungsschutz, Kochstoppautomatik
Bouilloire avec boîtier à double paroi en acier inoxydable Cromargan, puissance 2'400 watts, avec Safety Touch, base séparée avec enrouleur de câble, protection contre la marche à sec et la surchauffe, arrêt automatique de l'ébullition

Art-Nr./No d'article	Grösse/grandeur	Anschluss/puissance	Preis/prix
04.1321.0011	1,3 L / 23,4 x H 26,2 cm	220 V / 2,4 kW	99.75



T13



**WMF «Stelio»
Wasserkocher
Bouilloire**

Beleuchteter Wasserkocher aus Cromargan Edelstahl, 2'400 Watt Leistung, Gerätesockel inkl. Kabelaufwicklung, mit aussenliegender Wasserstandanzeige und herausnehmbarem, waschbaren Kalkfilter, gummierter und rutschfester Griff, Kochstoppautomatik und Deckelverriegelung
Bouilloire éclairée en acier inoxydable Cromargan, puissance 2'400 watts, socle de l'appareil y compris enrouleur de câble, avec indicateur de niveau d'eau extérieur et filtre anticalcaire amovible et lavable, poignée caoutchoutée et antidérapante, arrêt automatique de l'ébullition et verrouillage du couvercle

Art-Nr./No d'article	Grösse/grandeur	Anschluss/puissance	Preis/prix
04.1301.0012	1,2 L / Ø 16 x H 22 cm	220 V / 2,4 kW	62.30



T13



**Tefal «Principio Select»
Wasserkocher
Bouilloire**

360°-Mittelkontaktstation, Abschaltautomatik, Verdecktes Heizelement, Warmhaltefunktion
Station de contact centrale 360°, arrêt automatique, élément chauffant dissimulé, fonction maintien au chaud

Art-Nr./No d'article	Grösse/grandeur	Anschluss/puissance	Preis/prix
58.4615.2126	1,7 L / 23,8 x 22,5 x H 19 cm	220 V / 2,4 kW	50.55

KÜCHENMASCHINEN / MACHINES DE CUISINE



T13



KISAG Stabmixer inkl. Wandhalter Mixeur plongeur professionnel inclus support mural

Rührarm und Messer aus Inox 18/10, Stab ist fest montiert, geeignet für Dauerbetrieb, in jedem Kochgefäß einsetzbar
Tige et couteau en inox 18/10, tige non-démontable, pour emploi intensif, utilisable dans toutes les marmites, casseroles

Art-Nr./No d'article	Länge/longueur	Eintauchtiefe/immersion	Anschluss/puissance	Preis/prix
8006.96055	76 cm	50 cm	220 - 230 V / 0,4 kW	1093.85



T13



KISAG Stabmixer «Mini» inkl. Wandhalter Mixeur plongeur professionnel «Mini» inclus support mural

Stab, Fuss und Messer aus Inox 18/10, 2 Geschwindigkeiten: 20'000/15'000 U./Min., Verarbeitungsmenge bis 20 Liter, 2 Meter Kabel, Gewicht 1,2 kg
Tube, pied et couteau en inox 18/10, 2 vitesses: 20'000 / 15'000 RPM, capacité jusqu'à 20 litres, 2 mètres de cable, poids 1,2 kg

Art-Nr./No d'article	Länge/longueur	Eintauchtiefe/immersion	Anschluss/puissance	Preis/prix
8006.96057	38 cm	20 cm	230 V / 0,25 W	388.20



T13



**ROBOT COUPE® «MP»
Stabmixer
Mixeur plongeur professionnel**

Stab, Mischkopf und Messer aus Edelstahl, vollständiges Auseinandernehmen des Stabs und Messers

Manche, tête de mélange et lame en acier inoxydable, possibilité de retirer entièrement le manche et la lame

Art-Nr./No d'article	Eintauchtiefe/immersion		Anschluss/puissance	Preis/prix
8296.00022	35 cm	9500 U/min	230 V / 0,44 kW	822.30
8296.00023	45 cm	9500 U/min	230 V / 0,5 kW	894.05
8296.00024	55 cm	9000 U/min	230 V / 0,75 kW	1352.90
8296.00025	60 cm	9500 U/min	230 V / 0,85 kW	1588.20



Zubehör/Accessoires

8296.00030	Griff EASY GRIP für leichteres Arbeiten! Poignée EasyGrip pour un travail plus facile! Passend/pour 8296.00024, 8296.00025	191.70
-------------------	--	---------------



T13



**ROBOT COUPE® «MP V.V.»
Stabmixer
Mixeur plongeur professionnel**

Stab, Mischkopf und Messer aus Edelstahl, vollständiges Auseinandernehmen des Stabs und Messers, Drehzahl stufenlos 1500-9000 U/min

Manche, tête de mélange et lame en acier inoxydable, possibilité de retirer entièrement le manche et la lame, vitesse de rotation progressive 1500-9000 tr/min

Art-Nr./No d'article	Eintauchtiefe/immersion		Anschluss/puissance	Preis/prix
8296.00026	35 cm		230 V / 0,44 kW	894.05
8296.00027	45 cm		230 V / 0,5 kW	1023.45



T13



**ROBOT COUPE® «MP Combi»
Stabmixer inkl. Rührbesen
Mixeur plongeur professionnel avec fouet**

Stab, Mischkopf und Messer aus Edelstahl, vollständiges Auseinandernehmen des Stabs und Messers, Drehzahl stufenlos 250-9000 U/min

Manche, tête de mélange et lame en acier inoxydable, possibilité de retirer entièrement le manche et la lame, vitesse de rotation progressive 250-9000 tr/min

Art-Nr./No d'article	Eintauchtiefe/immersion		Anschluss/puissance	Preis/prix
8296.00028	35 cm		230 V / 0,44 kW	1352.90
8296.00029	45 cm		230 V / 0,5 kW	1588.20

KÜCHENMASCHINEN / MACHINES DE CUISINE



T13



NICHT FÜR DAUERNDEN
GEWERBLICHEN GEBRAUCH!
NE PAS POUR USAGE LOURDE!

BAMIX «Gastro Pro 1»

Weiss-lichtgrau, 2-Stufentechnik, 12'000 und 17'000 U/Min., zwei Geschwindigkeitsstufen, einen Sicherheitsknopf mit Softgrip, Spiralkabel weiss, Zubehör: Multimesser, Schlagscheibe, Quirl, Wandhalterung
Blanc-gris clair, 2 vitesses de rotation, 12'000 et 17'000 t/min., deux réglages de vitesse, d'un bouton de sécurité à prise souple, câble spiralé blanc, accessoires: couteau étoile, fouet, mélangeur, support mural

Art-Nr./No d'article	Länge/longueur	Eintauchtiefe/immersion	Anschluss/puissance	Preis/prix
8006.96069	34 cm	20 cm	230 V / 0,2 kW	258.55

Ersatzteile/Pièces de rechange

8006.96100	Multi-Messer/couteau étoile			21.15
-------------------	-----------------------------	--	--	--------------



T13



NICHT FÜR DAUERNDEN
GEWERBLICHEN GEBRAUCH!
NE PAS POUR USAGE LOURDE!

BAMIX «Gastro Pro 2»

Weiss-lichtgrau, 2-Stufentechnik, 12'000 und 17'000 U/Min., zwei Geschwindigkeitsstufen, einen Sicherheitsknopf mit Softgrip, Spiralkabel weiss, Zubehör: Multimesser, Schlagscheibe, Quirl, Wandhalterung
Blanc-gris clair, 2 vitesses de rotation, 12'000 et 17'000 t/min., deux réglages de vitesse, d'un bouton de sécurité à prise souple, câble spiralé blanc, accessoires: couteau étoile, fouet, mélangeur, support mural

Art-Nr./No d'article	Länge/longueur	Eintauchtiefe/immersion	Anschluss/puissance	Preis/prix
8006.96067	39,5 cm	25 cm	230 V / 0,2 kW	329.15

Ersatzteile/Pièces de rechange

8006.96100	Multi-Messer/couteau étoile			21.15
-------------------	-----------------------------	--	--	--------------



T13

**BAMIX «Gastro Pro 3»**

Weiss-lichtgrau, 2-Stufentechnik, 18'000 und 20'000 U/Min., zwei Geschwindigkeitsstufen, einen Sicherheitsknopf mit Softgrip, Spiralkabel weiss bis 4 m dehnbar, Zubehör: Multimesser, Schlagscheibe, Quirl, Wandhalterung
Blanc-gris clair, 2 vitesses de rotation, 18'000 et 20'000 t/min., deux réglages de vitesse, d'un bouton de sécurité à prise souple, câble spiralé blanc extensible jusqu'à 4 m, accessoires: couteau étoile, fouet, mélangeur, support mural

Art-Nr./No d'article	Länge/longueur	Eintauchtiefe/immersion	Anschluss/puissance	Preis/prix
8006.96068	49,5 cm	35 cm	230 V / 0,35 kW	435.05

Ersatzteile/Pièces de rechange

8006.96100	Multi-Messer/couteau étoile			21.15
-------------------	-----------------------------	--	--	--------------



T13

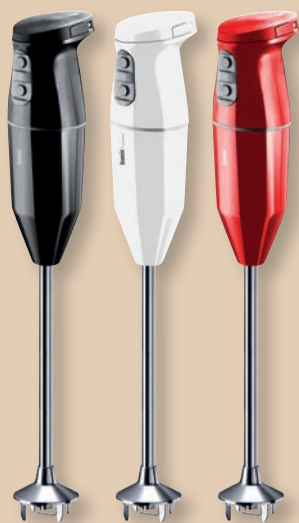

BAMIX «cordless PRO»

3-Stufentechnik bis 15'000 U/Min., Kabellos, superstarker Akku, Zuberhör: Multimesser, Schlagscheibe, Quirl, Ladestation
 Technologie à 3 niveaux jusqu'à 15'000 t/min, Sans fil, Batterie super puissante, Accessoires : Multi-couteau, Disque à battre, Fouet, Station de charge

Art-Nr./No d'article	Eintauchtiefe/immersion	Anschluss/puissance	Preis/prix
8006.96080	23 cm	220-240V	■ 469.35
8006.96081	23 cm	220-240V	□ 469.35
8006.96082	23 cm	220-240V	■ 469.35

Ersatzteile/Pièces de rechange

8006.96100	Multi-Messer/couteau étoile	21.15
------------	-----------------------------	-------



T13



PACOJET «Pacojet4»

Der neue Pacojet4 begeistert u.a. mit der Möglichkeit, bestimmte Rezepte in nur 90 Sekunden zu pacossieren®, sein grosser Touchscreen ermöglicht eine intuitive Benutzerführung sowie animierte Hilfestellung und die intelligenten Detektorfunktionen des Geräts schützen vor Fehlanwendungen. Während er besonders leise arbeitet, macht der neue Pacojet herausragende Ergebnisse bei maximaler Produktivität sowie leichter Bedienung möglich – und erfüllt damit langersehnte Kundenbedürfnisse.

Lieferumfang: 1 Pacojet4 Gerät, 1 Pacossier®-Flügel PJ4, 1 Kunststoff-Pacossier-Becher, 1 Schutzbecher PJ4, 1 Reinigungs-Tabs, 1 Spritzschutz PJ4 komplett
 Le nouveau Pacojet4 séduit notamment par la possibilité de pacosser® certaines recettes en seulement 90 secondes, son grand écran tactile permet un guidage intuitif de l'utilisateur ainsi qu'une aide animée et les fonctions de détection intelligentes de l'appareil protègent contre les erreurs d'utilisation. Tout en étant particulièrement silencieux, le nouveau Pacojet permet d'obtenir des résultats exceptionnels avec une productivité maximale et une grande facilité d'utilisation - et répond ainsi aux besoins des clients qui l'attendent depuis longtemps.

Contenu de la livraison: 1 appareil Pacojet4, 1 couteau de pacosage PJ4, 1 bol à pacosser synthétique, 1 récipient protecteur pour bol à pacosser synthétique PJ4, 1 comprimé de nettoyage, 1 protection anti-éclaboussures PJ4 complète

Art-Nr./No d'article	Grösse/grandeur	Gewicht/poids	Anschluss/puissance	Preis/prix
8270.41040			230 V / 1 kW	Auf Anfrage Sur demande



**PACOJET
 Coupe Set 4 tlg
 Coupe set 4 pcs**

2-Flügel-Messer, 4-Flügel-Messer, Schlagscheibe, Messerzange
 Compatible mit Pacojet4.

Couteau à 2 lames, couteau à 4 lames, disque à fouetter, pince à couteaux
 Compatible avec Pacojet4.

Art-Nr./No d'article	Preis/prix
8270.41049	Auf Anfrage Sur demande



PACOJET
Schutzbecher Pacojet4 für Chromstahl Pacossier®-Becher
Réceptif protecteur pour bol à paccoser inox

Kompatibel mit Pacojet4.
 Compatible avec Pacojet4.

Art-Nr./No d'article
8270.41041

Preis/prix
 Auf Anfrage
 Sur demande



PACOJET
Pacossier®-Becher aus Chromstahl
Bol à paccoser inox avec couvercle

Pacossier®-Becher inklusive dicht verschliessender Deckel.
 Kompatibel mit Pacojet4 und Pacojet2 PLUS.
 Bol à paccoser inox avec couvercle à fermeture hermétique.
 Compatible avec Pacojet4 et Pacojet2 PLUS.

Art-Nr./No d'article
8270.41042

Preis/prix
 Auf Anfrage
 Sur demande



PACOJET
Schutzbecher Pacojet4 für Kunststoff Pacossier®-Becher
Réceptif protecteur pour bol à paccoser synthétique

Kompatibel mit Pacojet4.
 Compatible avec Pacojet4.

Art-Nr./No d'article
8270.41043

Preis/prix
 Auf Anfrage
 Sur demande



PACOJET
Kunststoff Pacossier®-Becher
Bol à paccoser synthétique

Pacossier®-Becher inklusive dicht verschliessender Deckel.
 Kompatibel mit Pacojet4 und Pacojet2 PLUS.
 Bol à paccoser synthétiques avec couvercle à fermeture hermétique.
 Compatible avec Pacojet4 et Pacojet2 PLUS.

Art-Nr./No d'article
8270.41044

Preis/prix
 Auf Anfrage
 Sur demande



PACOJET
Kunststoff Pacossier®-Becher, 12er set
Bols à paccoser synthétiques, Set à 12

Set von 12 Pacossier®-Bechern inklusive dicht verschliessender Deckel.
 Kompatibel mit Pacojet4 und Pacojet2 PLUS.
 Jeux de 12 bols à paccoser synthétiques avec couvercle à fermeture hermétique.
 Compatible avec Pacojet4 et Pacojet2 PLUS.

Art-Nr./No d'article
8270.40033

Preis/prix
 Auf Anfrage
 Sur demande



PACOJET
Pacossier-Flügel PJ4
Couteau de pacassage PJ4

Kompatibel mit Pacojet4 und Pacojet2 PLUS.
 Compatible avec Pacojet4 et Pacojet2 PLUS.

Art-Nr./No d'article
8270.41045

Preis/prix
 Auf Anfrage
 Sur demande



PACOJET
Spritzschutz PJ4 komplett
Protection contre les projections PJ4

inkl. Vorabstreifer. Kompatibel mit Pacojet4.
 Pré-stripper incl. Compatible avec Pacojet4.

Art-Nr./No d'article
8270.41046

Preis/prix
 Auf Anfrage
 Sur demande



PACOJET
Vorabstreifer PJ4
Pré-stripper PJ4

Kompatibel mit Pacojet4.
 Compatible avec Pacojet4.

Art-Nr./No d'article
8270.41047

Preis/prix
 Auf Anfrage
 Sur demande



PACOJET
Reinigungstabs
Comprimés pour nettoyage

60 Tabs à 3 g
 60 Tabs à 3 g

Art-Nr./No d'article
8270.41050

Preis/prix
 Auf Anfrage
 Sur demande



PACOJET
Pajojet Care Rezeptbuch
Livre de recettes

2-sprachige Ausgabe: Deutsch, Englisch
 Édition bilingue: allemand, anglais

Art-Nr./No d'article
8270.41048

Preis/prix
 Auf Anfrage
 Sur demande

KÜCHENMASCHINEN / MACHINES DE CUISINE



T13

**WMF «KultXPro»
Hochleistungsstandmixer
Blender à haute performance**

Standmixer aus Cromargan Edelstahl matt für Getränke, Aufstriche, Dips und Dressings, Püree und leichte Teige, 1'600 Watt Leistung, 36'000 Umdrehungen/min, 6 flügeliges Edelstahlmesser, mit Display für Geschwindigkeits- und Zeiteinstellung, Mixfunktion nur bei geschlossenem Deckel

Mixeur sur pied en acier inoxydable Cromargan mat pour boissons, pâtes à tartiner, dips et vinaigrettes, purées et pâtes légères, puissance 1'600 watts, 36'000 tours/minute, lame en acier inoxydable à 6 pales, avec écran pour le réglage de la vitesse et du temps, fonction mixage uniquement avec couvercle fermé

Art-Nr./No d'article	Grösse/grandeur	Anschluss/puissance	Preis/prix
04.1663.0011	20 x 23 x H 49,5 cm	220 V / 1,63 kW	371.70



T13

**ROTOR «GK910»
Profi-Küchenmixer
Mixer professionnel**

Motorblock für Aufsätze mit Füllmengen bis 4 L aus Edelstahl oder Polycarbonat. Speziell entwickelt für die gewerbliche Küche. Stufenlose, elektronische Drehzahlregelung und 900 Watt Dauerleistung, Spitze ca. 1600W. Bedienung mit Drehknopf, leise in der Anwendung, einfach zu reinigen. AUFSATZ IM LIEFERUMFANG NICHT ENTHALTEN!

Bloc moteur pour bols mélangeur d'une capacité jusqu'à 4 L en inox ou en polycarbonate. Spécialement développé pour la cuisine commerciale. Réglage de vitesse électronique en continu et puissance continue de 900 watts, maximum d'environ 1600W. Avec dispositif de protection, silencieux à utiliser, facile à nettoyer. BOL MELANGEUR NON INCLUS!

Art-Nr./No d'article	Grösse/grandeur	Anschluss/puissance	Preis/prix
8006.96136	20 x 20 cm x H 24,5 cm	220 V / 1,6 kW	1093.85

Zubehör/Accessoires

8006.96143	Aufsatz 2 L, Polycarbonat Réipient 2 L, en polycarbonat	206.95
8006.96146	Aufsatz 4 L, Polycarbonat Réipient 4 L, en polycarbonat	469.35
8006.96145	Aufsatz 2 L, Inox Réipient 2 L, en inox 18/10	469.35
8006.96147	Aufsatz 4 L, Inox Réipient 4 L, en inox 18/10	694.00

AUFSATZ IM LIEFERUMFANG NICHT ENTHALTEN!
BOL MELANGEUR NON INCLUS !



T13

**ROTOR «GK950»
Profi-Küchenmixer
Mixer professionnel**

Motorblock für Aufsätze mit Füllmengen bis 4 L aus Edelstahl oder Polycarbonat. Speziell entwickelt für die gewerbliche Küche. Variable Drehzahl, 950 Watt Dauerleistung, Spitze ca. 1700W. Touch or Turn®, automatische Programme, Puls, Timer. Mit Schutzvorrichtung, leise in der Anwendung, einfach zu reinigen. AUFSATZ IM LIEFERUMFANG NICHT ENTHALTEN!

Bloc moteur pour bols mélangeur d'une capacité jusqu'à 4 L en inox ou en polycarbonate. Spécialement développé pour la cuisine commerciale. Vitesse variable, puissance continue de 950 watts, maximum d'environ 1700W. Touch or Turn®, programmes automatiques, puls, minuterie. Avec dispositif de protection, silencieux à utiliser, facile à nettoyer. BOL MELANGEUR NON INCLUS!

Art-Nr./No d'article	Grösse/grandeur	Anschluss/puissance	Preis/prix
8006.96135	19 x 19 cm x H 22,6 cm	230 V / 1,7 kW	1173.95

Zubehör/Accessoires

8006.96143	Aufsatz 2 L, Polycarbonat Réipient 2 L, en polycarbonat	206.95
8006.96146	Aufsatz 4 L, Polycarbonat Réipient 4 L, en polycarbonat	469.35
8006.96145	Aufsatz 2 L, Inox Réipient 2 L, en inox 18/10	469.35
8006.96147	Aufsatz 4 L, Inox Réipient 4 L, en inox 18/10	694.00

AUFSATZ IM LIEFERUMFANG NICHT ENTHALTEN!
BOL MELANGEUR NON INCLUS !



T13



ROBOT COUPE® «R 2»

**Tischkutter
Cutter de table**

Für grobes und feines Hacken, Emulgieren, Verrühren, Zerkleinern und Kneten. Pulsbetrieb auf Knopfdruck. Maximale Verarbeitungsmengen: Hacken: 0,8 kg, Emulgieren: 1 kg, Kneten: 0,5 kg, Zerkleinern: 0,3 kg
 Pour le hachage, farces fines, mousses, broyage et pétrissage.
 Commande pulsée au bouton. Capacité de charge maximale: hachage: 0,8 kg, émulsions: 1 kg, pâtes: 0,5 kg, broyages: 0,3 kg

«R 2»

Drehzahl/Vitesse 1500 U/min

Art-Nr./No d'article	Grösse/grandeur	Anschluss/puissance	Preis/prix
8296.00007	2,9 L / 200 x 280 x H 350 mm	230 V / 550 W	1171.30



T13



ROBOT COUPE® «R 3»

**Tischkutter
Cutter de table**

Für grobes und feines Hacken, Emulgieren, Verrühren, Zerkleinern und Kneten. Pulsbetrieb auf Knopfdruck. Maximale Verarbeitungsmengen: Hacken: 1 kg, Emulgieren: 1,5 kg, Zerkleinern: 0,5 kg
 Pour le hachage, farces fines, mousses, broyage et pétrissage.
 Commande pulsée au bouton. Capacité de charge maximale: hachage: 1 kg, émulsions: 1,5 kg, broyages: 0,5 kg

«R 3 / 3000»

Drehzahl/Vitesse 3000 U/min

Art-Nr./No d'article	Grösse/grandeur	Anschluss/puissance	Preis/prix
8296.00008	3,7 L / 210 x 320 x H 400 mm	230 V / 650 W	2493.85



T13

8296.00010

8296.00009



**ANSCHLUSS BAUSEITIG!
CONNEXION
MONTÉE SUR SITE!**



ROBOT COUPE® «R 4»

**Tischkutter
Cutter de table**

Für grobes und feines Hacken, Emulgieren, Verrühren, Zerkleinern und Kneten. Pulsbetrieb auf Knopfdruck. Maximale Verarbeitungsmengen: Hacken: 1,5 kg, Emulgieren: 2,5 kg, Kneten: 1,5 kg, Zerkleinern: 0,7 kg
 Pour le hachage, farces fines, mousses, broyage et pétrissage.
 Commande pulsée au bouton. Capacité de charge maximale: hachage: 1,5 kg, émulsions: 2,5 kg, pâtes: 1,5 kg, broyages: 0,7 kg

«R 4»

Drehzahl/Vitesse 1500 + 3000 U/min

Art-Nr./No d'article	Grösse/grandeur	Anschluss/puissance	Preis/prix
8296.00009	4,5 L / 225 x 305 x H 440 mm	400 V / 900 W	2822.10

«R 4 - V.V.»

Stufenlose Drehzahl/Vitesse réglable 300-3500 U/min

Art-Nr./No d'article	Grösse/grandeur	Anschluss/puissance	Preis/prix
8296.00010	4,5 L / 225 x 305 x H 460 mm	230 V / 1000 W	3289.90



T13

8296.00012

8296.00011



**ANSCHLUSS BAUSEITIG!
CONNEXION
MONTÉE SUR SITE!**



ROBOT COUPE® «R 5»

**Tischkutter
Cutter de table**

Für grobes und feines Hacken, Emulgieren, Verrühren, Zerkleinern und Kneten. Pulsbetrieb auf Knopfdruck. Maximale Verarbeitungsmengen: Hacken: 2,2 kg, Emulgieren: 3,2 kg, Kneten: 2,2 kg, Zerkleinern: 1,1 kg
 Pour le hachage, farces fines, mousses, broyage et pétrissage.
 Commande pulsée au bouton. Capacité de charge maximale: hachage: 2,2 kg, émulsions: 3,2 kg, pâtes: 2,2 kg, broyages: 1,1 kg

«R 5 - 2V»

Drehzahl/Vitesse 1500 + 3000 U/min

Art-Nr./No d'article	Grösse/grandeur	Anschluss/puissance	Preis/prix
8296.00011	5,9 L / 265 x 350 x H 540 mm	400 V / 1500 W	3798.80

«R 5 - V.V.»

Stufenlose Drehzahl/Vitesse réglable 300-3500 U/min

Art-Nr./No d'article	Grösse/grandeur	Anschluss/puissance	Preis/prix
8296.00012	5,9 L / 265 x 350 x H 540 mm	230 V / 1500 W	4340.00

KÜCHENMASCHINEN / MACHINES DE CUISINE



T13

**ROBOT COUPE® «Blixer 2»**

Zwei Geräte in einem. Cutter und Emulgator. Dank verriegelbarer Schüssel können rohe oder gekochte Lebensmittel zu breiigen, halbflüssigen oder flüssigen Endprodukten püriert oder verdünnt werden.

Deux appareils en un. Cutter et blender/mixer. Grâce à la cuve avec sécurité d'ouverture, des aliments cuits ou crus, mixés, liquides, semi-liquides ou pâteux sont facilement réalisables.

«Blixer 2»

Drehzahl/Vitesse 3000 U/min

Art-Nr./No d'article Grösse/grandeur

8296.00021 2,9 L / 210 x 281 x H 389 mm

Anschluss/puissance

230 V / 700 W

Preis/prix

2116.40

T13

**ROBOT COUPE® «Blixer 3»**

Zwei Geräte in einem. Cutter und Emulgator. Dank verriegelbarer Schüssel können rohe oder gekochte Lebensmittel zu breiigen, halbflüssigen oder flüssigen Endprodukten püriert oder verdünnt werden.

Deux appareils en un. Cutter et blender/mixer. Grâce à la cuve avec sécurité d'ouverture, des aliments cuits ou crus, mixés, liquides, semi-liquides ou pâteux sont facilement réalisables.

«Blixer 3»

Drehzahl/Vitesse 3000 U/min

Art-Nr./No d'article Grösse/grandeur

8296.00017 3,7 L / 242 x 304 x H 444 mm

Anschluss/puissance

230 V / 750 W

Preis/prix

2586.85

T13

8296.00019**8296.00018**

ANSCHLUSS BAUSEITIG!
CONNEXION
MONTÉE SUR SITE!

**ROBOT COUPE® «Blixer 4»**

Zwei Geräte in einem. Cutter und Emulgator. Dank verriegelbarer Schüssel können rohe oder gekochte Lebensmittel zu breiigen, halbflüssigen oder flüssigen Endprodukten püriert oder verdünnt werden.

Deux appareils en un. Cutter et blender/mixer. Grâce à la cuve avec sécurité d'ouverture, des aliments cuits ou crus, mixés, liquides, semi-liquides ou pâteux sont facilement réalisables.

«Blixer 4 – 2V»

Drehzahl/Vitesse 1500 + 3000 U/min

Art-Nr./No d'article Grösse/grandeur

8296.00018 4,5 L / 226 x 332 x H 479 mm

Anschluss/puissance

400 V / 1000 W

Preis/prix

3057.40**«Blixer 4 – V.V.»**

Stufenlose Drehzahl/Vitesse réglable 300-3500 U/min

Art-Nr./No d'article Grösse/grandeur

8296.00019 4,5 L / 226 x 332 x H 479 mm

Anschluss/puissance

230 V / 1100 W

Preis/prix

3798.80

T13

**ROBOT COUPE® «Blixer 5»**

Zwei Geräte in einem. Cutter und Emulgator. Dank verriegelbarer Schüssel können rohe oder gekochte Lebensmittel zu breiigen, halbflüssigen oder flüssigen Endprodukten püriert oder verdünnt werden.

Deux appareils en un. Cutter et blender/mixer. Grâce à la cuve avec sécurité d'ouverture, des aliments cuits ou crus, mixés, liquides, semi-liquides ou pâteux sont facilement réalisables.

«Blixer 5 – V.V.»

Stufenlose Drehzahl/Vitesse réglable 300-3500 U/min

Art-Nr./No d'article Grösse/grandeur

8296.00020 5,9 L / 280 x 365 x H 540 mm

Anschluss/puissance

230 V / 1500 W

Preis/prix

4998.00



8296.00013
8296.00015

T13

8296.00014



ANSCHLUSS BAUSEITIG!
CONNEXION
MONTÉE SUR SITE!



ROBOT COUPE®

Combi: Kutter/Gemüseschneider
Combi: Cutter/Coupe-légumes

Zwei Geräte in einem (Motorblock + Kutteraufsatz + Gemüseschneideraufsatz). Sämtliche Aufsätze in robustem pflegeleichtem Inox. Grosse Schnittvielfalt mit 27 verschiedene Schneidescheiben (sind separat zu bestellen), Kutterschüssel 3,5 L (entspricht Modell R 3). Zusätzliche Zitruspresse als Option.

Deux appareils en un (bloc moteur + accessoire cutter + accessoire coupe-légumes). Tous les accessoires en inox 18/10 facile à entretenir. Grande diversité de coupe par 27 disques de différentes coupes (à commander en plus). Cuve cutter en inox 18/10 de 3,5 litres (correspond au modèle R3). Presse agrumes en option.

«R 401»

Drehzahl/Vitesse 1500 U/min

Art-Nr./No d'article	Grösse/grandeur	Anschluss/puissance	Preis/prix
8296.00013	32 x 30,4 x H 57 cm	230 V / 700 W	3289.90

«R 402»

Drehzahl/Vitesse 750+1500U/min

Art-Nr./No d'article	Grösse/grandeur	Anschluss/puissance	Preis/prix
8296.00014	32 x 30,4 x H 59 cm	400 V / 750 W	3410.00

«R 402»

Stufenlose Drehzahl/Vitesse réglable 300 – 3000 U/min

Art-Nr./No d'article	Grösse/grandeur	Anschluss/puissance	Preis/prix
8296.00015	32 x 30,4 x H 59 cm	230 V / 1000 W	4340.00



Art-Nr./No d'article	Artikel/article	Grösse/grandeur	Preis/prix
8296.10000	Schneidescheibe/Coupe	1 mm	93.75
8296.10001	Schneidescheibe/Coupe	2 mm	93.75
8296.10002	Schneidescheibe/Coupe	3 mm	93.75
8296.10003	Schneidescheibe/Coupe	4 mm	93.75
8296.10004	Schneidescheibe/Coupe	5 mm	93.75
8296.10005	Schneidescheibe/Coupe	6 mm	93.75
8296.10006	Wellenscheibe/Coupe ondulé	2 mm	93.75



Art-Nr./No d'article	Artikel/article	Grösse/grandeur	Preis/prix
8296.10007	Streifenscheibe/Bâtonnets	2x2 mm	98.55
8296.10008	Streifenscheibe/Bâtonnets	2x4 mm	98.55
8296.10009	Streifenscheibe/Bâtonnets	2x6 mm	98.55
8296.10010	Streifenscheibe/Bâtonnets	4x4 mm	98.55
8296.10011	Streifenscheibe/Bâtonnets	6x6 mm	98.55
8296.10012	Streifenscheibe/Bâtonnets	8x8 mm	98.55
8296.10013*	Pommes-frites	8x8 mm	378.80
8296.10014*	Pommes-frites	10x10 mm	378.80
8296.10015*	Würfel/Macédoine	8x8mm	378.80
8296.10016*	Würfel/Macédoine	10x10 mm	378.80

* Nur für 402 und 402 VV



Art-Nr./No d'article	Artikel/article	Grösse/grandeur	Preis/prix
8296.10017	Reibenscheibe/Râpeur	1,5 mm	93.75
8296.10018	Reibenscheibe/Râpeur	2 mm	93.75
8296.10019	Reibenscheibe/Râpeur	3 mm	93.75
8296.10020	Reibenscheibe/Râpeur	6 mm	93.75
8296.10021	Reibenscheibe/Râpeur	9 mm	93.75
8296.10022	Parmesanscheibe/Parmesan		98.75
8296.10023	Radieschenscheibe/Radis	0,7 mm	152.90
8296.10024	Radieschenscheibe/Radis	1 mm	152.90
8296.10025	Radieschenscheibe/Radis	1,3 mm	152.90
8296.10026	Kartoffelscheibe/Pommes de terre		152.90



Art-Nr./No d'article	Artikel/article	Grösse/grandeur	Preis/prix
8296.00016	Zitruspresse/Presse-agrumes	Ø 175 mm	324.65

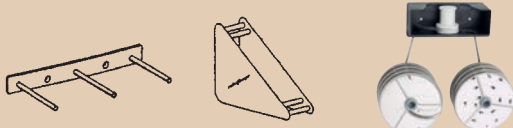

Art-Nr./No d'article	Artikel/article	Preis/prix
8296.10027	Gestell für 6 Scheiben/ Rack pour 6 disques	86.90
8296.10028	Gestell für eine Scheibe/ Rack pour 1 disque	21.15
8296.10030	Wandhalterung für Messer und 8 Scheiben Support mural pour couteau et 8 disques	56.40

KÜCHENMASCHINEN / MACHINES DE CUISINE



T13

**BRUNNER-ANLIKER «GSM 5 Star»
Gemüseschneidemaschine
Coupe légumes**

Schneidaufsatz aus massivem Edelstahl, Leistung bis 150 kg/h, einfache und schalterlose Bedienung, ziehender Schnitt, ca. 50 verschiedene Schnittvarianten, antimikrobielle und HACCP-freundliche Schneidscheiben aus Glasfaserverbundstoff (separat erhältlich), ergonomische 45-Grad-Position, Induktionsmotor und Getriebe wartungs- und servicefrei, 5 Jahre Garantie auf Motor und Getriebe. Inkl. Drehstößel

Dispositif de coupe en fonte d'incox massive, performance jusqu'à 150 kg/h, commande simple sans commutateur, coupe en tirant, env. 50 types de coupes différentes, disques de coupe anti-microbiens conformes aux consignes HACCP, fabriqués en matériau composite en fibre de verre (disponible séparément), l'inclinaison ergonomique à 45 degrés, moteur à induction et l'engrenage n'exigent ni maintenance ni entretien, 5 ans de garantie sur le moteur et l'engrenage. Incl. pilon roeatif

Art-Nr./No d'article	Grösse/grandeur	Gewicht/poids	Anschluss/puissance	Preis/prix
8297.00010	25 x 31,5 x H 54 cm	21,5 kg	230 V / 0,425 kW	5387.00

Ersatzteile/Pièces de rechange

8297.00050	Drehstößel Pilon roeatif	188.20
-------------------	-----------------------------	---------------



T13

**BRUNNER-ANLIKER «Anliker L CH»
Gemüseschneidemaschine
Coupe légumes**

Schneidaufsatz und Gehäuseunterteil aus Glasfaserverbundstoff mit integrierten Silberionen für bessere Hygiene, Leistung bis 220 kg/h, einfache und schalterlose Bedienung, ziehender Schnitt, ca. 50 verschiedene Schnittvarianten, antimikrobielle und HACCP-freundliche Schneidscheiben aus Glasfaserverbundstoff (separat erhältlich), ergonomische 45-Grad-Position, Induktionsmotor und Getriebe wartungs- und servicefrei, 5 Jahre Garantie auf Motor und Getriebe

Tête de coupe et partie inférieure du carter en matériau composite de fibre de verre avec ions d'argent antibactérien intégrés pour une hygiène améliorée, performance jusqu'à 220 kg/h, commande simple sans commutateur, coupe en tirant, env. 50 types de coupes différentes, disques de coupe anti-microbiens conformes aux consignes HACCP, fabriqués en matériau composite en fibre de verre (disponible séparément), l'inclinaison ergonomique à 45 degrés, moteur à induction et l'engrenage n'exigent ni maintenance ni entretien, 5 ans de garantie sur le moteur et l'engrenage

Art-Nr./No d'article	Grösse/grandeur	Gewicht/poids	Anschluss/puissance	Preis/prix
8297.00015	25 x 31,5 x H 54 cm	19 kg	230 V / 0,26 kW	3998.50

Zubehör/Accessoires

8297.00016	Double-Shot Set Set double-shot	234.05
-------------------	------------------------------------	---------------

**Schneidscheiben zu «GSM 5 Star und Anliker L CH»
Disques pour «GSM 5 Star et Anliker L CH»**

Schneidscheiben aus Glasfaser-Verbundstoff, antimikrobiell
Disques en composite chargé de fibres de verre, antimicrobiens

Art-Nr./No d'article	Artikel/article	Grösse/grandeur	Preis/prix
8297.00041	① F1 Feinschnitt/Tranche fines	1 mm	234.05
8297.00042	② G3 Grobschnitt/Coupe épaisse	3 mm	234.05
8297.00043	③ S2 Juliennes	2 mm	367.00
8297.00044	④ PA4 Allumettes	4 mm	367.00
8297.00045	⑤ W6 Würfel/Cubes	6 mm	670.50
8297.00046	⑥ No0 Raffelscheibe/Râpe	9 mm	312.90
8297.00048	⑦ No00 Raffelscheibe Rösti/Râpe Rösti	11 mm	312.90
8297.00047	⑧ BR Brunoise	4 mm	336.40
8297.00020	B2/10 Scheibenprogramm/Set de disques		2939.75
	F1 Feinschnitt/Tranche fines	1 mm	
	G3 Grobschnitt/Coupe épaisse	3 mm	
	S2 Juliennes	2 mm	
	PA4 Allumettes	4 mm	
	PG4 Gaufrettes	4 mm	
	No0 Rösti	9 mm	
	BT8 Bâtonnets	8 mm	
	W10 Würfel/Cubes	10 mm	
8297.00030	B2 Boxensystem/Système (6 kleine und 1 grosse Box/6 petits et 1 grand box)		670.50

Weitere Scheiben
auf Anfrage

Plusieurs disques
sur demande



T13



**ROTOR «Varimat Inox Gourmet»
Gemüseschneidemaschine
Coupe légumes**

Rostfreier Edelstahl, Spülmaschinenfestes Gehäuse und Zusatzteile, Verstellbare Schneidscheibe, Verstellbare Schnittgeschwindigkeit, Scheiben aus Edelstahl, Zusatzelement Scheibenständer für 6 Scheiben Inox
Acier inoxydable, boîtier et accessoires lavables au lave-vaisselle, disque de coupe réglable, vitesse de coupe réglable, disques en acier inoxydable, élément supplémentaire support de disques pour 6 disques en inox

Art-Nr./No d'article	Grösse/grandeur	Gewicht/poids	Anschluss/puissance	Preis/prix
8006.96110	53 x 27 x H 55 cm	27 kg	230 V / 0,4 kW	4704.45

Zubehör/Accessoires
8006.96109 Zubehör-Set bestehend aus **2704.45**
7 Scheiben (S0-8, J2x2, R1.5, R3, R9, G4, B3x3),
2 Scheibenständer für je 6 Scheiben, 1 Stössel Maxi-Gourmet
Zubehör-Set bestehend aus
Set de 7 disques (S0-8, J2x2, R1.5, R3, R9, G4, B3x3),
2 supports pour 6 disques, 1 pilon maxi-gourmet



Bei Würfelscheibe immer das passende Messer mitbestellen!
En cas de disque de découpage en dés, toujours commander la lame correspondante!

Weitere Scheiben auf Anfrage
Plusieurs disques sur demande

**Edelstahl-Schneidscheiben zu Rotor «Varimat»
Disques en inox pour Rotor «Varimat»**

Art-Nr./No d'article	Artikel/article	Grösse/grandeur	Preis/prix
8006.96113	① Verstellbar/Réglable	0-8 mm	468.20
8006.96114	① S10 Scheiben/Disque à émincer	10 mm	458.55
8006.96115	② J2x2 Juliennes	2x2 mm	340.50
8006.96116	② J3x3 Allumettes	3x3 mm	340.50
8006.96117	② J4x4 Allumettes	4x4 mm	340.50
8006.96118	③ WS2 Wellen/Ondulé	2 mm	258.55
8006.96119	③ WS3 Wellen/Ondulé	3 mm	258.55
8006.96120	④ R1.5 Raffelscheibe/Râpe	1,5 mm	176.20
8006.96121	④ R2 Raffelscheibe/Râpe	2 mm	176.20
8006.96122	④ R3 Raffelscheibe/Râpe	3 mm	176.20
8006.96123	④ Reibscheibe/Râpe	2x2 mm	176.20
8006.96124	⑤ B2x2 Brunoise	2x2 mm	351.50
8006.96125	⑤ B3x3 Brunoise	3x3 mm	351.50
8006.96126	⑤ B4x4 Brunoise	4x4 mm	351.50
8006.96127	⑥ G4 Gaufrette	4 mm	270.35
8006.96128	⑥ G6 Gaufrette	6 mm	270.35
8006.96129	⑦ WG6 Würfel ohne Messer Cubes sans couteau	6x6 mm	764.45
8006.96130	⑦ WM6 Messer/Couteau	6x6 mm	233.85
8006.96131	⑦ WG8 Würfel ohne Messer Cubes sans couteau	8x8 mm	703.50
8006.96132	⑦ WM8 Messer/Couteau	8x8 mm	233.85



T13



**ROBOT COUPE® «Robot Cook®»
Mehrzweckgerät
Robot multifonctions**

Mit dem Robot Cook lässt sich kneten, hacken, vermischen, pürieren, emulgieren, zermahlen, sowie wärmen und kochen. Einstellbare Heizkraft bis 140° C, stufenlose Drehzahlregelung bis 3500 U/min mit Turbo-Taste bis 4500 U/min, robuster Hochleistungs-Asynchronmotor, angenehm leise. Warmhalten des Verarbeitungsgutes, Messer-Rückhalte Mechanismus für sicheres Ausleeren, Fassungsvermögen von 3,7 Liter, leicht zu reinigen und spülmaschinenfest.
Le Robot Cook permet de pétrir, hacher, mélanger, mixer, émulsionner, broyer de même que réchauffer et cuire. Puissance de chauffe modulable jusqu'à 140° C, régulation de la vitesse de rotation jusqu'à 3500 tr/min, avec la touche turbo jusqu'à 4500 tr/min, moteur asynchrone d'une grande robustesse et agréablement silencieux. Garde au chaud la matière à travailler, système de retenue du couteau pour vider la préparation en toute sécurité, capacité de 3,7 litres, facile à nettoyer et résistant au lave-vaisselle.

Art-Nr./No d'article	Grösse/grandeur	Gewicht/poids	Anschluss/puissance	Preis/prix
8296.10040	22,6 x 33,8 x H 52,2 cm	15 kg	230 V / 1,8 kW	4340.00



T13



**«Teddy T5»
Planeten-Rührmaschine
Mélangeur planétaire**

Besen, Flachrührer, Einfülltrichter und Knetler aus Edelstahl, Chromstahlkessel, Spritzschutzschirm aus Kunststoff, Stufenlose Geschwindigkeitsregelung der Rührwerkzeuge

Fouet, batteur plat, trémie d'alimentation et pétrisseur en acier inoxydable, cuve en acier chromé, protection anti-projection en plastique, réglage progressif de la vitesse des outils de mélange

Art-Nr./No d'article	Grösse/grandeur	Anschluss/puissance	Preis/prix
8006.96170	5 L / 46,2 x 24 x H 55 cm / 22 kg	230 V / 0,5 kW	1952.75



T13



**«Alphamix2»
Standrührgerät
Batteur mélangeur**

Rahmen aus Gussaluminium, Transparenter Schutzschirm aus Polycarbonat, Behälter aus rostfreiem Edelstahl, Fassungsvermögen 5,5 l, Rührutensilien aus Gussaluminium und rostfreiem Edelstahl: Schneebesen, Rührer, Knethaken. Der Zubehöranschluss verwandelt das Rührgerät in einen vielseitigen Küchenroboter mit folgenden Optionen: Fleischwolf, Gemüsehobel und die meisten Zubehörtteile mit 10 x 10 Vierkantmuffe.

Bâti en fonte d'aluminium, écran de sécurité transparent en polycarbonate, cuve en acier inoxydable d'une contenance de 5,5 L., en fonte d'aluminium et acier inoxydable : fouet, palette, crochet. Prise d'accessoires transforme le batteur en robot polyvalent grâce aux options disponibles: hachoir, coupe-légumes et la plupart des accessoires à manchon carré 10 x 10 existant.

Art-Nr./No d'article	Grösse/grandeur	Anschluss/puissance	Preis/prix
8006.97006	5 L / 28,4 x 38,2 x H 43,4 cm	230 V / 0,5 kW	1694.05

Für Ersatzteile wenden Sie sich an unseren Innendienst.
Renseignez-vous auprès de notre service interne concernant les pièces de rechange.

**NICHT FÜR DAUERNDEN
GEWERBLICHEN GEBRAUCH!
NE PAS POUR USAGE LOURDE!**



T13



**«Alphamix2»
Standrührgerät
Batteur mélangeur**

Rahmen aus Gussaluminium, Transparenter Schutzschirm aus Polycarbonat, Behälter aus rostfreiem Edelstahl, Fassungsvermögen 8 l, Rührutensilien aus Gussaluminium und rostfreiem Edelstahl: Schneebesen, Rührer, Knethaken. Der Zubehöranschluss verwandelt das Rührgerät in einen vielseitigen Küchenroboter mit folgenden Optionen: Fleischwolf, Gemüsehobel und die meisten Zubehörtteile mit 10 x 10 Vierkantmuffe.

Bâti en fonte d'aluminium, écran de sécurité transparent en polycarbonate, cuve en acier inoxydable d'une contenance de 8 L., en fonte d'aluminium et acier inoxydable: fouet, palette, crochet. Prise d'accessoires transforme le batteur en robot polyvalent grâce aux options disponibles: hachoir, coupe-légumes et la plupart des accessoires à manchon carré 10 x 10 existant.

Art-Nr./No d'article	Grösse/grandeur	Anschluss/puissance	Preis/prix
8006.97007	8 L / 31,8 x 46,5 x H 40 cm	230 V / 0,7 kW	2822.10

Für Ersatzteile wenden Sie sich an unseren Innendienst.
Renseignez-vous auprès de notre service interne concernant les pièces de rechange.



Fleischwolf Hachoir

Zum Hacken und Zerkleinern von Fleisch, Fisch, Gemüse, trockenem Brot, festen Früchten oder Käse. Komplett mit Messer mit vier selbstschärfenden Edelstahlklingen. Grober und feiner Edelstahlmahlscheibe. inkl. Stopfer/Schlüssel.
Cet accessoire permet de hacher ou broyer la viande, le poisson, les légumes, le pain sec, les fruits é chair fermé de le fromage.

Art-Nr./No d'article Passend zu/pour
8006.98041 Kitchenaid/Alphamix

Preis/prix
218.80

NICHT FÜR DAUERNDEN
GEWERBLICHEN GEBRAUCH!
NE PAS POUR USAGE LOURDE!



Zitruspresse Presse-agrumes

Saftpresse für die schnelle und einfache Herstellung von Orangen-, Grapefruit-, Zitronensaft und sonstigen Zitrusäften.
Cet accessoire permet de réaliser des jus d'agrumes frais.

Art-Nr./No d'article Passend zu/pour
8006.98046 Kitchenaid/Alphamix

Preis/prix
139.90

NICHT FÜR DAUERNDEN
GEWERBLICHEN GEBRAUCH!
NE PAS POUR USAGE LOURDE!

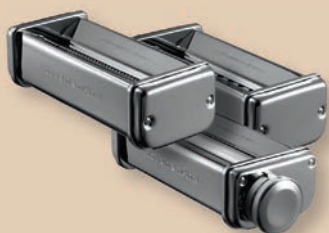

Satz mit 3 Nudelrollen Set de 3 rouleux à pâtes

Dreiteiliges Set aus langlebigem, verchromtem Metall: Der Teigroller kann Lasagne mit einer Breite von bis zu 140 mm herstellen, zwei Messer stehen für die Zubereitung von frischer Tagliatelle oder Spaghetti zur Verfügung.
Cet accessoire est composé de trois éléments fabriqués en métal chromé résistant: un rouleau permettant de confectionner des feuilles de pâte atteignant 140 mm de large et deux couteaux permettant de préparer des tagliatelles ou des spaghettis frais.

Art-Nr./No d'article Passend zu/pour
8006.98047 Kitchenaid/Alphamix

Preis/prix
411.70

NICHT FÜR DAUERNDEN
GEWERBLICHEN GEBRAUCH!
NE PAS POUR USAGE LOURDE!



T13



«CR20»
Planeten-Rührmaschine, Tischmodell
Mélangeur planétaire, modèle de table

Edelstahl, Stufenlose Geschwindigkeitsregelung der Rührwerkzeuge, Steuerung 8 Drehzahlen, Timer, inkl. Zubehör: Chromstahlkessel, Besen aus Edelstahl, Flachrührer aus Edelstahl, Kneiter aus Edelstahl
 Acier inoxydable, réglage progressif de la vitesse des outils de mélange, commande 8 vitesses de rotation, avec minuterie, accessoires incl: cuve en acier chromé, fouet en inox, batteur plat en inox et pétrisseur en inox

Art-Nr./No d'article	Grösse/grandeur	Anschluss/puissance	Preis/prix
8006.96171	77,1 x 58,2 x H78,7 cm / 72 kg	230 V / 0,7 kW	8069.80



«CR20»
Unterbau
Sous-structure

Edelstahl, mit Schublade und ausziehbarem Tablar
 Acier inoxydable, avec tiroir et tablette coulissante

Art-Nr./No d'article	Grösse/grandeur	Preis/prix
8006.96172	70 x 67 x H 50,5 cm	2341.15



T13



«CR20F»
Planeten-Rührmaschine, Bodenmodell
Mélangeur planétaire, modèle de sol

Edelstahl, Standmodell inkl. Kesselwagen, Stufenlose Geschwindigkeitsregelung der Rührwerkzeuge, Steuerung 8 Drehzahlen, Timer, inkl. Zubehör: Chromstahlkessel, Besen aus Edelstahl, Flachrührer aus Edelstahl, Kneiter aus Edelstahl, Kesselwagen
 Acier inoxydable, modèle sur pied avec chariot de cuve, réglage progressif de la vitesse des outils de mélange, commande 8 vitesses de rotation, avec minuterie, accessoires incl: cuve en acier chromé, fouet en inox, batteur plat en inox, pétrisseur en inox et chariot de cuve

Art-Nr./No d'article	Grösse/grandeur	Anschluss/puissance	Preis/prix
8006.96173	77 x 63,1 x H 123,2 cm / 165 kg	230 V / 0,7 kW	8939.75

Ersatzteile/Pièces de rechange

8006.96176	Chromstahlkessel/Cuve en acier chromé	623.50
8006.96177	Besen aus Edelstahl/Fouet en inox	319.95
8006.96178	Flachrührer aus Edelstahl/Batteur plat en inox	319.95
8006.96179	Kneiter aus Edelstahl/Pétrisseur en inox	319.95
8006.96180	Kesselwagen/Chariot de cuve	647.00



T13



**NICHT FÜR DAUERNDEN
GEWERBLICHEN GEBRAUCH!
NE PAS POUR USAGE LOURDE!**

**Fleischwolf
Hâchoir**

Gestell aus Aluminium, Getriebeuntersetzung aus Stahl, Mühltrichter aus Edelstahl, Mühltrichter und Mahlanlage abnehmbar für leichte Reinigung, Lieferung inklusive 1 Messer und 1 Lochscheibe 6 mm, Scheibendurchmesser 70 mm, Leistung: 160 kg pro Stunde

Support en aluminium, transmission en acier, hachoir en acier inoxydable, mécanisme facile de démontage pour un entretien aisé, 1 couteau et 1 trémie 6 mm compris dans la livraison, Diamètre du disque 70 mm, Production: 160 kg/heure

Art-Nr./No d'article	Grösse/grandeur	Gewicht/poids	Anschluss/puissance	Preis/prix
8270.90617	29 x 46 x H 50 cm	20 kg	230 V / 0,75 kW	1717.60

Zubehör/Accessoires

8270.90618	Lochscheibe 2 mm / Trémie 2 mm	102.10
8270.90619	Lochscheibe 4,5 mm / Trémie 4,5 mm	81.15
8270.90620	Lochscheibe 8 mm / Trémie 8 mm	81.15
8270.90621	Messer/Couteau	44.65



T15



**FEUMA «TW R70»
Fleischwolf
Hachoir**

Komplett aus Edelstahl, System Unger 3-teilig bestehend aus Vorschneider, Messer und Lochscheibe inkl. 3 Lochscheiben (3, 5, 8 mm), 1 Vorwärtsgang und Impulsstufe für Rückwärtslauf, Effiziente Verarbeitung von Fleisch, Fisch und Gemüse, Leistung: 150 kg/h

Entièrement en acier inoxydable, système Unger en trois parties composé d'une ébaucheuse, d'un couteau et de 3 disques perforés (3,5, 8 mm), 1 mode marche avant et mode impulsion pour la marche arrière, préparation efficace de la viande, du poisson et des légumes, performance: 150 kg/h

Art-Nr./No d'article	Grösse/grandeur	Gewicht/poids	Anschluss/puissance	Preis/prix
8006.96174	42,2 x 27 x H 59,1 cm	23 kg	400 V / 0,83 kW	2822.10



**ANSCHLUSS BAUSEITIG!
CONNEXION
MONTÉE SUR SITE!**



T15



**FEUMA «TW H82»
Fleischwolf
Hachoir**

Komplett aus Edelstahl, System Unger 3-teilig bestehend aus Vorschneider, Messer und Lochscheibe inkl. 3 Lochscheiben (3, 5, 8 mm), Effiziente Verarbeitung von Fleisch, Fisch und Gemüse, Leistung: bis zu 350 kg/h

Entièrement en acier inoxydable, système Unger en trois parties composé d'une ébaucheuse, d'un couteau et de 3 disques perforés (3,5, 8 mm), préparation efficace de la viande, du poisson et des légumes, performance: jusqu'à 350 kg/h

Art-Nr./No d'article	Grösse/grandeur	Gewicht/poids	Anschluss/puissance	Preis/prix
8006.96175	60,2 x 35,7 x H 59,7 cm	35 kg	400 V / 1,1 kW	5387.00



**ANSCHLUSS BAUSEITIG!
CONNEXION
MONTÉE SUR SITE!**

KÜCHENMASCHINEN / MACHINES DE CUISINE



T13



STETIGE REINIGUNG
UNERLÄSSLICH!
NETTOYAGE RÉGULIER
PRIMORDAL!

ZUMEX «Minex» Orangensaftpresse Presse-agrumes

13 Orangen/Minute, Durchmesser Frucht: 6,5-7,8 cm, Integrierter Saftbehälter 0,75 Liter
13 oranges/minute, diamètre de fruit: 6,5-7,8 cm, récipient de jus intégré 0,75 litre

Art-Nr./No d'article	Grösse/grandeur	Gewicht/poids	Anschluss/puissance	Preis/prix
8006.96167	36,5 x 36 x H 72 cm	19,5 kg	230 V / 0,24 kW	3752.70



T13



ROTOR «Sanamat» Obst- und Gemüsesaftzentrifuge Centrifugeuse pour fruits et légumes

Saftsammelschale aus Edelstahl, Deckel aus Edelstahl mit grossem Rundschacht, Schleuderkorb aus Edelstahl, Gehäuse aus Edelstahl, Massiver Stössel, HACCP konform

Bac de récupération du jus en acier inoxydable, couvercle en acier inoxydable avec grand puits rond, panier de centrifugation en acier inoxydable, boîtier en acier inoxydable, coulisseau massif, conforme HACCP

Art-Nr./No d'article	Grösse/grandeur	Gewicht/poids	Anschluss/puissance	Preis/prix
8006.96161	35,5 x 20 x H 39,5 cm	7,5 kg	230 V / 0,6-1,1 kW	2069.80

Zubehör/Accessoires

8006.96162	Zusätzlicher Tresterbehälter Réservoir de pulpe supplémentaire	58.80
8006.96163	Zusätzlicher Schleuderkorb komplett Panier de centrifugation complet supplémentaire	258.80



T13



ROTOR «Vitamit» Obst- und Gemüsesaftzentrifuge Centrifugeuse pour fruits et légumes

Edelstahlgehäuse, Hygienische Saftsammelschale aus Edelstahl, Deckel mit grossem exzentrischem Rundschacht aus Edelstahl, Schleuderkorb komplett aus Edelstahl, 1 massiver Stössel (rund), Extrem hohe Saftausbeute und sehr leise, HACCP konform

Boîtier en acier inoxydable, bac de récupération du jus hygiénique en acier inoxydable, couvercle avec grand puits rond excentré en acier inoxydable, panier de centrifugation entièrement en acier inoxydable, 1 coulisseau massif (rond), rendement de jus très élevé, très silencieuse, conforme HACCP

Art-Nr./No d'article	Grösse/grandeur	Gewicht/poids	Anschluss/puissance	Preis/prix
8006.96164	47,5 x 27,7 x H 61 cm	16,5 kg	230 V / 0,9-1,6 kW	3752.70

Zubehör/Accessoires

8006.96165	Zusätzlicher Tresterbehälter Réservoir de pulpe supplémentaire	117.25
8006.96166	Zusätzlicher Schleuderkorb komplett Panier de centrifugation complet supplémentaire	398.55



T13



ROBOT COUPE® «J80»

**Entsafter
Centrifugeuse**

Höchste Entsaftungsleistung durch Hochleistungsmotor (700W) mit hoher, gleichbleibender Drehzahl von 3000 U / min.. Einfach zu reinigen. Grosse Kapazität bis zu 120 Liter / Stunde. Tropfenfänger für saubere Arbeitsfläche, Saftaustritt mit Anti-Spritz-Funktion.

Une meilleure prestation de l'extraction parce qu'un moteur à grande puissance (700W) avec une haute, constante fréquence de rotation de 3000 U / min.. Simple nettoyage. Grande capacité jusqu'à de 120 Litres / heures. Pare-gouttes pour un plan de travail propre, départ de jus avec une fonction d'anti giclements.

Art-Nr./No d'article	Grösse/grandeur	Gewicht/poids	Anschluss/puissance	Preis/prix
8296.10050	23,5 x 53,8 x H 50,6 cm	13 kg	230 V / 0,7 kW	2069.80



T13



ROBOT COUPE® «J80 Buffet»

**Entsafter
Centrifugeuse**

Höchste Entsaftungsleistung durch Hochleistungsmotor (700W) mit hoher, gleichbleibender Drehzahl von 3000 U / min.. Einfach zu reinigen. Grosse Kapazität bis zu 120 Liter / Stunde. Tropfenfänger für saubere Arbeitsfläche, Saftaustritt mit Anti-Spritz-Funktion.

Une meilleure performance de l'extraction des jus grâce à un moteur de haute puissance (700W) avec une haute, constante fréquence de rotation de 3000 U / min.. Simple nettoyage. Grande capacité jusqu'à de 120 Litres / heures. Pare-gouttes pour un plan de travail propre, départ de jus avec une fonction d'anti giclements.

Art-Nr./No d'article	Grösse/grandeur	Gewicht/poids	Anschluss/puissance	Preis/prix
8296.10052	26,2 x 56,6 x H 59,5 cm	13 kg	230 V / 0,7 kW	2493.85



T13



ROBOT COUPE® «J100»

**Entsafter
Centrifugeuse**

Höchste Entsaftungsleistung durch Hochleistungsmotor (1000W) mit hoher, gleichbleibender Drehzahl von 3000 U / min.. Einfach zu reinigen. Grosse Kapazität bis zu 160 Liter / Stunde. Tropfenfänger für saubere Arbeitsfläche, Saftaustritt mit Anti-Spritz-Funktion. Grosse Nutzfläche des Geräts für die Verwendung eines Mixbehälters unter dem Saftaustritt.

Une meilleure performance de l'extraction des jus grâce à un moteur de haute performance (1000W), avec une vitesse élevée et constante 3000 t/min. Facile à nettoyer. Grand débit jusqu'à 160 litres/heure. Bec verseur pour un plan de travail propre, départ de jus avec une fonction d'anti giclements. Grande surface sous l'appareil pour positionner un récipient sous le bec verseur.

Art-Nr./No d'article	Grösse/grandeur	Gewicht/poids	Anschluss/puissance	Preis/prix
8296.10051	26,2 x 56,6 x H 62,8 cm	15 kg	230 V / 1 kW	3057.40

KÜCHENMASCHINEN / MACHINES DE CUISINE



T13



NICHT FÜR DAUERNDEN
GEWERBLICHEN GEBRAUCH!
NE PAS POUR USAGE LOURDE!

«Joy» Zitruspresse Presse-agrume

Mit 3 verschiedenen Presskegeln für Orangen, Grapefruits oder Zitronen!
Gehäuse Aluguss, Saftbehälter und Presskegel aus Kunststoff.
Avec 3 ogives différentes pour oranges, grapefruits ou citrons!
Boîtier en fonte d'aluminium, récipient et ogives en matière synthétique.

Gerät ist nicht für den dauerhaften gewerblichen Einsatz geeignet.
Cet appareil ne se prête pas à un usage professionnel prolongé.

Art-Nr./No d'article	Grösse/grandeur	Gewicht/poids	Anschluss/puissance	Preis/prix
8270.90171	21 x 32 x H 41,5 cm	5,5 kg	230 V / 0,18 kW	351.70



T13



Dörrapparat für Gemüse und Früchte Déshydrateur à fruits et légumes

Für einfache und praktische Trocknung von Kräutern, Früchten und Gemüsen für Dekore, Saucen, Salate und Suppen.
Gehäuse aus recycelbarem Kunststoff schwarz, 9 Auflagegitter 380 x 380 mm aus lebensmittelechtem Polypropylen, Dörretemperatur stufenlos einstellbar von 40 bis 74°C, Timer (Zeitschaltuhr) für 26 Stunden
Une façon simple et pratique pour conserver herbes, fruits et légumes.
Idéal pour conserver les produits destinés à la fabrication de pains, décors de pâtisserie, pizza, sauces, plats de pâtes, omelettes, salades, soupes, etc.
Châssis composite noir avec porte, 9 étages de séchage équipés de plateaux grillagés 380 x 380 mm, thermostat réglable 40 à 74°C, minuteur 26 heures.

Art-Nr./No d'article	Grösse/grandeur	Gewicht/poids	Anschluss/puissance	Preis/prix
8006.96220	42 x 32 x H 49 cm	8,5 kg	230 V / 0,6 kW	1173.95

Zubehör zu Dörrapparat Accessoires pour déshydrateur

① **Polyrack**
Einschubgitter aus lebensmittelechtem Polypropylen als Unterlage für die Backauflagen.
Etagère grillagée, en polypropylène noir, destinée à supporter les feuilles Polyscreen ou les toiles silicone.

Art-Nr./No d'article	Grösse/grandeur	Preis/prix
8006.96221	38,1 x 38,1 cm	56.40

② **Polyscreen**
Matte zum Polyrack aus lebensmittelechtem Polypropylen mit nicht-haftender Wabenstruktur.
Feuille pour le Polyrack en polypropylène souple à structure gaufrée. La structure gaufrée évite le collage des aliments

Art-Nr./No d'article	Grösse/grandeur	Preis/prix
8006.96222	35,5 x 35,5 cm	28.20

③ **Paraflexx®**
Silikonmatte für sehr feuchte Produkte. Austern, Fruchtpüree, etc. Passend zu Polyrack.
Plaque silicone souple, à utiliser pour les produits très humides: huîtres, purée de fruits, etc. Dimensions adaptées au Polyrack.

Art-Nr./No d'article	Grösse/grandeur	Preis/prix
8006.96223	35,5 x 35,5 cm	44.65

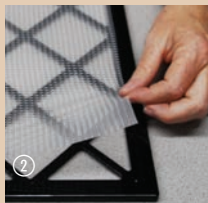
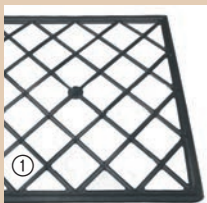



IMPERIA
Pastamaschine manuell
Machine à pâtes manuelle

Chromstahlgehäuse, Walzen aus Edelstahl, bis zu ca. 12 kg Teigplatten pro Stunde, 10 verschiedene Stärken des Nudelteiges einstellbar, für Teigplatten Breite 21 cm, Öffnung der Walzen max. 5 mm, Lieferumfang: Trichter, Kurbel und Spannbacke.
Boîtier en acier chromé, rouleaux en inox, jusqu'à 12 kg de feuilles de pâte par heure environ, 10 épaisseurs différentes de pâte réglables, pour des feuilles de pâte largeur 21 cm, ouverture des rouleaux max. 5 mm, contenu de la livraison : entonnoir, manivelle et mâchoire de serrage.

Art.-Nr./No d'article	Grösse/grandeur	Gewicht/poids	Preis/prix
8270.90710	49 x 34 x H 26 cm	10,3 kg	764.65



T13



IMPERIA
Pastamaschine elektrisch
Machine à pâtes électrique

Chromstahlgehäuse, Walzen aus Edelstahl, bis zu ca. 14 kg Teigplatten pro Stunde, 10 verschiedene Stärken des Nudelteiges einstellbar, für Teigplatten Breite 21 cm, Öffnung der Walzen max. 5 mm, Lieferumfang: Trichter mit Sicherheitsvorrichtung und Antrieb für Schneidwalzen. Schneidwalzen sind optional erhältlich.
Boîtier en acier chromé, rouleaux en inox, jusqu'à 14 kg de feuilles de pâte par heure environ, 10 épaisseurs différentes de pâte réglables, pour des feuilles de pâte largeur 21 cm, ouverture des rouleaux max. 5 mm, contenu de la livraison : entonnoir avec dispositif de sécurité et moteur pour rouleaux de coupe. Des rouleaux de coupe sont disponibles en option.

Art.-Nr./No d'article	Grösse/grandeur	Gewicht/poids	Anschluss/puissance	Preis/prix
8270.90721	30 x 22 x 25 cm	14,8 kg	230 V / 0,3 kW	2069.80



T13



IMPERIA
Pastamaschine elektronisch
Machine à pâtes électrique

Chromstahlgehäuse, Walzen aus Edelstahl, bis zu ca. 16 kg Teigplatten pro Stunde, 10 verschiedene Stärken des Nudelteiges einstellbar, für Teigplatten Breite 21 cm, Öffnung der Walzen max. 5 mm, Geschwindigkeitsstufeneinstellung, Kontrollleuchte, Lieferumfang: Trichter mit Sicherheitsvorrichtung und Antrieb für Schneidwalzen. Schneidwalzen sind optional erhältlich.
Boîtier en acier chromé, rouleaux en inox, jusqu'à 16 kg de feuilles de pâte par heure environ, 10 épaisseurs différentes de pâte réglables, pour des feuilles de pâte largeur 21 cm, ouverture des rouleaux max. 5 mm, réglage de la vitesse, lampe de contrôle, contenu de la livraison : entonnoir avec dispositif de sécurité et moteur pour rouleaux de coupe. Des rouleaux de coupe sont disponibles en option.

Art.-Nr./No d'article	Grösse/grandeur	Gewicht/poids	Anschluss/puissance	Preis/prix
8270.90731	30 x 22 x 25 cm	14,8 kg	230 V / 0,3 kW	2341.15

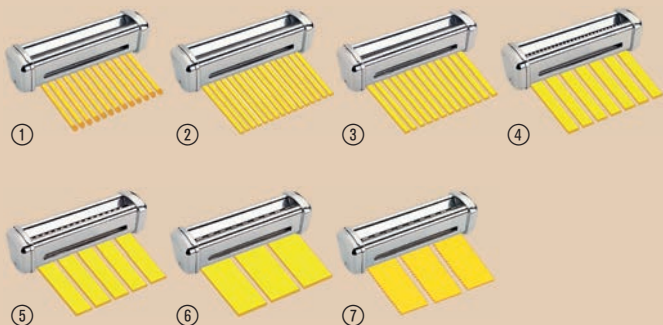

IMPERIA
Schneidwalzen zu Imperia Pastamaschine
Cylindres de coupe pour Imperia Pastamachine

Passend zu 8270.90721 und 8270.90731
Compatible avec 8270.90721 et 8270.90731

Art.-Nr./No d'article	Artikel/article	Grösse/grandeur	Preis/prix
8270.90751	① Spaghetti	Ø 2 mm	195.25
8270.90752	② Capelli d'angelo	1,5 mm	195.25
8270.90753	③ Tagliatelle	2,0 mm	195.25
8270.90754	④ Trenette	4,0 mm	195.25
8270.90755	⑤ Fettuccine	6,5 mm	195.25
8270.90756	⑥ Lasagnette	12,0 mm	195.25
8270.90757	⑦ Reginette Lasagnette	12,0 mm	195.25

KÜCHENMASCHINEN / MACHINES DE CUISINE



T13

**ROTOR «AGC»
Aufschnittmaschine
Trancheuse**

Gradschnitt, Keramik, mit Schleifvorrichtung und einfach abnehmbarem Messer
EasyClean: Die Maschinen verfügen über eine aufsteckbare Vorrichtung, mit der sich das scharfe Messer zur Reinigung ohne Werkzeug und ohne Verletzungsgefahr leicht entfernen lässt.

Coupe droite, céramique, avec dispositif de meulage et lame facile à retirer
EasyClean: Les machines disposent d'un système avec lequel le couteau très tranchant peut être démonté facilement, sans outils, pour le nettoyage sans risque de blessures.

Art-Nr./No d'article	Grösse/grandeur	Messer/couteau	Anschluss/puissance	Preis/prix
8006.96150	62 x 47 x H 42,5 cm	275 mm	230 V / 0,24 kW	3352.70
8006.96151	63 x 43 x H 49 cm	300 mm	230 V / 0,37 kW	4423.25
8006.96152	79 x 74 x H 59 cm	350 mm	230 V / 0,37 kW	5564.45

EASY CLEAN



T13

HOFMANN «Gastroline A 2505»

Alu/Inox, Gradschnitt, Schnittdicke 0 – 20 mm, Schnittkapazität 220 x 180 mm.
Die ideale Allrounderin für den Einsatz im Gastgewerbe.

Alu/Inox, coupe droite, épaisseur de coupe 0 – 20 mm, capacité de coupe 220 x 180 mm. Une vraie polyvalente pour l'utilisation dans la gastronomie.

Art-Nr./No d'article	Stand/base	Messer/couteau	Anschluss/puissance	Preis/prix
8455.00031	550 x 310 mm	250 mm	230 V / 0,3 kW	3729.20



T13

HOFMANN «Gastroline A 3005»

Alu/Inox, Gradschnitt, Schnittdicke 0 – 20 mm, Schnittkapazität 220 x 195 mm.
Die ideale Allrounderin für den Einsatz im Gastgewerbe.

Alu/Inox, coupe droite, épaisseur de coupe 0 – 20 mm, capacité de coupe 220 x 195 mm. Une vraie polyvalente pour l'utilisation dans la gastronomie.

Art-Nr./No d'article	Stand/base	Messer/couteau	Anschluss/puissance	Preis/prix
8455.00032	550 x 310 mm	300 mm	230 V / 0,3 kW	4223.30



T13

**HOFMANN «Gastroline B 2505»
Brotscneider
Trancheuse à pain**

Alu/Inox, Schrägschnitt, Schnittdicke 0 – 20 mm, Schnittkapazität 220 x 180 mm.
Gezahntes Spezialmesser für einen perfekten Schnitt. Die nach hinten versetzte Anschlagplatte ermöglicht problemloses Schneiden von dicken Brotscheiben.

Alu/Inox, coupe inclinée, épaisseur de coupe 0 – 20 mm, capacité de coupe 220 x 180 mm. Lame dentée pour une coupe parfaite. La plaque de butée est décalée vers l'arrière pour faciliter la coupe des tranches de pain épaisses.

Art-Nr./No d'article	Stand/base	Messer/couteau	Anschluss/puissance	Preis/prix
8455.00033	550 x 310 mm	250 mm	230 V / 0,3 kW	3729.20



T13



HOFMANN «Maestroline A 2580»

Aluguss, Schrägschnitt, Schnittdicke 0 – 12 mm, Schnittkapazität 230 x 190 mm. Die Schrägschneider mit Riemenantrieb sind ideal für kleinere, sparsame Bedürfnisse. Die extreme Schrägstellung des Schlittens garantiert den selbstständigen Nachschub des Schnittguts. Griffiger Einstellknopf für die stufenlose Wahl der Scheibendicke.

Fonte d'alù, coupe inclinée, épaisseur de coupe 0 – 12, capacité de coupe 230 x 190 mm. Les trancheuses inclinées à entraînement par courroie conviennent parfaitement aux petits besoins et aux économes. Le chariot extrêmement incliné assure un glissement parfait de la pièce vers la lame. Grand bouton de réglage maniable pour le choix de l'épaisseur de la tranche en continu.

Art-Nr./No d'article	Stand/base	Messer/couteau	Anschluss/puissance	Preis/prix
8455.00025	455 x 295 mm	250 mm	230 V / 0,3 kW	3175.00



T13

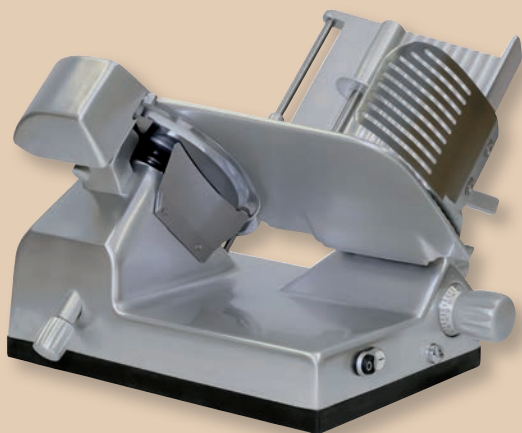

HOFMANN «Maestroline A 3080»

Aluguss, Schrägschnitt, Schnittdicke 0 – 14 mm, Schnittkapazität 260 x 210 mm. Die Schrägschneider mit Riemenantrieb sind ideal für kleinere, sparsame Bedürfnisse. Die extreme Schrägstellung des Schlittens garantiert den selbstständigen Nachschub des Schnittguts. Griffiger Einstellknopf für die stufenlose Wahl der Scheibendicke.

Fonte d'alù, coupe inclinée, épaisseur de coupe 0 – 14 mm, capacité de coupe 260 x 210 mm. Les trancheuses inclinées à entraînement par courroie conviennent parfaitement aux petits besoins et aux économes. Le chariot extrêmement incliné assure un glissement parfait de la pièce vers la lame. Grand bouton de réglage maniable pour le choix de l'épaisseur de la tranche en continu.

Art-Nr./No d'article	Stand/base	Messer/couteau	Anschluss/puissance	Preis/prix
8455.00030	520 x 360 mm	300 mm	230 V / 0,3 kW	4223.30



T13



HOFMANN «Bistroline A 1980»

Aluguss, Gradschnitt, Schnittdicke 0 – 15 mm, Schnittkapazität 190 x 140 mm. Der kleine Profi für die Theke. Ideal für kleinere Gastgewerbebetriebe wie Bistros, Tea Rooms, Saison- und Sportrestaurants usw.

Fonte d'alù, coupe droite, épaisseur de coupe 0 – 15 mm, capacité de coupe 190 x 140 mm. Le petit professionnel du bar. Convient aux petites entreprises de restauration telles que cafés, tearooms, restaurants saisonniers et buvettes de terrains de sport.

Art-Nr./No d'article	Stand/base	Messer/couteau	Anschluss/puissance	Preis/prix
8455.00034	410 x 280 mm	190 mm	230 V / 0,3 kW	1694.05



T13



**Universalwaage geeicht
Balance universelle étalonnée**

Diät- und Küchenwaage, Kontrollwaage in Industrie & Labor, Funktion zum Wägen und Trieren, Wiegefläche: 23,3 x 19,2 cm, Display hinterleuchtet, geeicht, Überlastschutz, robust, inkl. Akku und Netzadapter
Balance de précision et de cuisine, balance de contrôle dans le secteur industriel et les laboratoires, fonction de pesage et de tarage, surface de pesage: 23,3 x 19,2 cm, écran rétroéclairé, étalonnée, protection contre la surcharge, robuste, avec batterie et adaptateur secteur

Art-Nr./No d'article	Grösse/grandeur	Wägebereich; Messung/pesage; graduation	Preis/prix
8252.00005	23,5 x 30,5 x H 12,8 cm	6 kg (0-3 kg; 1 gr / 3-6 kg; 2 gr)	635.25
8252.00006	23,5 x 30,5 x H 12,8 cm	15 kg (0-6 kg; 2 gr / 6-15 kg; 5 gr)	635.25

KÜCHENMASCHINEN / MACHINES DE CUISINE



T13

Elektronische Küchenwaage
Balance électronique

Wiegefläche: 28 x 21,5 cm, Anschluss 230 V / 7 W, geeignet für nicht eichpflichtige Wägungen, inklusive Akku und Netzteil
 Plateau de pesage 28 x 21,5 cm, puissance 230 V / 7 W, non étalonnée, accu et transformateur inclus

Art-Nr./No d'article	Grösse/grandeur	Wägebereich; Messung/pesage; graduation	Preis/prix
8208.00010	29 x 33 x H 12,5 cm / 5kg	15 kg; 5 gr	312.90



T13

Elektronische Küchen- und Gastronomiewaage
Balance électronique cuisine et gastronomie

Einfach zu bedienen, präzise und zuverlässig, ungeeicht, Netzbetrieb oder Batterie, Waageplatzform: 23,5 x 17,5 cm
 Facile à utiliser, précise et fiable, non étalonné, alimentation secteur ou piles, plateau de balance: 23,5 x 17,5 cm

Art-Nr./No d'article	Grösse/grandeur	Wägebereich; Messung/pesage; graduation	Preis/prix
8324.40000	29 x 24,5 cm x H 10 cm	15 kg; 5 gr	218.80

Ersatzteile/Pièces de rechange

8324.40001	Ersatz-Netzadapter/Adaptateur de rechange	39.95
-------------------	---	--------------



T13

Elektronische Digital-Waage
Balance digitale

Edelstahl, Betrieb erfolgt über ein Netzteil oder mit 6 AA Batterien, die Fernanzeige ist zur Wandmontage geeignet, die Wendelleitung überbrückt eine Distanz von 60-70 cm, Wiegefläche: 31 x 30 cm, Anschluss: 230 V / 20 W, geeignet für nicht eichpflichtige Wägungen
 Inox, fonctionne sur secteur ou sur piles AA, le téléaffichage convient pour un montage mural, affichage à distance par câble spiralé de 60-70 cm, plateau de pesage 31 x 30 cm, puissance 230 V / 20 W, non étalonnée

Art-Nr./No d'article	Grösse/grandeur	Wägebereich; Messung/pesage; graduation	Preis/prix
8208.00011	31 x 30 x H 5 cm / 4,5 kg	60 kg; 20 gr	265.85

Elektronische Küchenwaage
Balance de cuisine

Intuitive Touch-Bedienung sowie ein gut lesbares LED-Display, grosse Wiegefläche aus satiniertem Edelstahl umrandet in Kunststoff, wiegt exakt in 1-Gramm-Schritten von 5 g bis 15 kg, Anzeige in Gramm, Pfund und Unzen, Zuwiegefunktion Tara und Extrafunktion zum kurzzeitigen speichern der Messung, intuitive Touch-Bedienung mit 4 AA-Batterien

Commande tactile intuitive ainsi qu'écran LED bien lisible, grande surface de pesage en acier inoxydable satiné entouré de plastique, pèse de manière précise par pas de 1 gramme de 5 g à 15 kg, affichage en grammes, livres et onces, fonction d'ajout de tare et fonction supplémentaire pour l'enregistrement bref de la mesure, commande tactile intuitive avec 4 piles AA



Art-Nr./No d'article	Grösse/grandeur	Wägebereich; Messung/pesage; graduation	Preis/prix
8102.10580	31 x 25,5 cm x H 2,8 cm	15 kg; 1 gr	73.85



Küchenwaage digital
Balance de cuisine digitale

Sicherheitsglas und Kunststoff, Feinteilung 1 g bis 5 kg, misst in g, oz, lb und ml, intuitive Touch-Bedienung, zuwiegefunktion Tara, durchgehende Glasfläche, ultraflach und modern, rutschfeste Gummifüsschen, inkl. Knopf-batterie
Verre de sécurité et plastique, pèse de manière précise par pas de 1 g à 5 kg, affichage en g, oz, lb et ml, commande tactile intuitive, fonction d'ajout de tare, surface en verre continue, ultra lisse et moderne, pieds en caoutchouc antidérapants, pile bouton comprise

Art.-Nr./No d'article	Grösse/grandeur	Wägebereich; Messung/pesage; graduation	Preis/prix
8102.10511	16 x 21 cm x H 1,5 cm	5 kg; 1 gr	42.30



T13



ERME «T1C»
Vakuuiermaschine, antrazith matt
Appareil à emballer sous vide

Swissmade, Stahlgehäuse pulverbeschichtet antrazith matt, Vakuunkammer aus Edelstahl, Vakuumpumpe Saugleistung 4 m3/h, Kammergrösse: 26 x 31 x 9 cm, Schweisslänge: 25,5 cm, Pumpe: 4 m3/h, max. Beutel: 24,5 x 40 cm
Swissmade, boîtier en acier revêtu par poudre anthracite mat, chambre à vide en acier inoxydable, pompe à vide puissance d'aspiration 4 m3/h, dimensions de la chambre: 26 x 31 x 9 cm, longueur de soudure: 25,5 cm, pompe: 4 m3/h, max. sachets: 24,5 x 40 cm

Art.-Nr./No d'article	Grösse/grandeur	Gewicht/poids	Anschluss/puissance	Preis/prix
8006.90980	30 x 51 x H 21,5 cm	27 kg	230 V / 0,12 kW	3410.40



T13



«Evolution 300 pro»
Vakuu-Verpackungsmaschine
Appareil à emballer sous vide

Made in Germany, Komplett aus Edelstahl, Hochleistungs-Vakuumpumpe, Grosse tiefgezogene Vakuunkammer, Versenkte Steuerung, Breite Doppelschweissung, Einlegeplatten zur Höhenverstellung, gewölbter Plexiglasdeckel.
Kammergrösse: 32 x 35 x 12 cm, Schweisslänge: 30,5 cm, Distanz: 29 cm, Pumpe: 8 cmb/h, max. Beutel: 30 x 40 cm
Made in Germany, entièrement en acier inoxydable, pompe à vide haute performance, grande chambre à vide profonde, commande encastrée, double soudage, plaques d'insertion pour l'ajustement en hauteur, couvercle en plexiglas. Mesure de chambre sous vide: 32 x 35 x 12 cm, longueur de soudage: 30,5 cm, distance: 29 cm, pompe: 8 cbm/h, sachet max.: 30 x 40 cm

Art.-Nr./No d'article	Grösse/grandeur	Gewicht/poids	Anschluss/puissance	Preis/prix
8270.90460	37 x 40 x H 30,5 cm	28 kg	230 V / 0,5 kW	2939.75



T13



«Evolution 300 plus»
Vakuu-Verpackungsmaschine
Appareil à emballer sous vide

Made in Germany, Komplett aus Edelstahl, Hochleistungs-Vakuumpumpe, Grosse tiefgezogene Vakuunkammer, Versenkte Steuerung, sensorgesteuerte Elektronik, Schweißen und Trennen, Einlegeplatten zur Höhenverstellung, gewölbter Plexiglasdeckel.
Kammergrösse: 32 x 35 x 12 cm, Schweisslänge: 30,5 cm, Distanz: 29 cm, Pumpe: 8 cmb/h, max. Beutel: 30 x 40 cm
Made in Germany, entièrement en acier inoxydable, pompe à vide haute performance, grande chambre à vide profonde, commande encastrée, avec électronique commandé par capteur, soudage et découpe, plaques d'insertion pour l'ajustement en hauteur, couvercle en plexiglas. Mesure de chambre sous vide: 32 x 35 x 12 cm, longueur de soudage: 30,5 cm, distance: 29 cm, pompe: 8 cbm/h, sachet max.: 30 x 40 cm

Art.-Nr./No d'article	Grösse/grandeur	Gewicht/poids	Anschluss/puissance	Preis/prix
8270.90470	37 x 40 x H 30,5 cm	28 kg	230 V / 0,5 kW	3289.90

KÜCHENMASCHINEN / MACHINES DE CUISINE



T13

**«Vacuboy»
Vakuum-Verpackungsmaschine
Appareil à emballer sous vide**

Made in Germany, Komplet aus Edelstahl, Hochleistungs-Vakuumpumpe, Vakuumstoptaste, Elektronische Steuerung, Breite Doppelschweissung, Einlegeplatten zur Höhenverstellung, gewölbter Plexiglasdeckel.
Kammergrösse: 36 x 38 x 14 cm, Schweisslänge: 35 cm, Distanz: 34 cm, Pumpe: 10 cbm/h, max. Beutel: 35 x 40 cm
Fabriqu  en Allemagne, en inox, pompe   sous vide   haut d bit, touche d'arr t de sous vide, contr le  lectronique, plaques d'insertion pour l'ajustement en hauteur, couvercle en plexiglas.
Mesure de chambre sous vide: 36 x 38 x 14 cm, longueur pour soudage: 35 cm, distance : 34 cm, pompe: 10 cbm/h, max. sachet: 35 x 40 cm

Art-Nr./No d'article	Grösse/grandeur	Gewicht/poids	Anschluss/puissance	Preis/prix
8270.90420	40 x 50 cm x H 36 cm	40 kg	230 V / 0,63 kW	3880.00



T13

**«Vacuboy perfect»
Vakuum-Verpackungsmaschine
Appareil   emballer sous vide**

Made in Germany, Komplet aus Edelstahl, Hochleistungs-Vakuumpumpe, Vakuumstoptaste, sensorgesteuerte Elektronik, Breite Doppelschweissung, Einlegeplatten zur Höhenverstellung, gew lbter Plexiglasdeckel.
Kammergrösse: 36 x 38 x 14 cm, Schweissl nge: 35 cm, Distanz: 34 cm, Pumpe: 10 cbm/h, max. Beutel: 35 x 40 cm
Fabriqu  en Allemagne, en inox, pompe   sous vide   haut d bit, touche d'arr t de sous vide, avec  lectronique command  par capteur, plaques d'insertion pour l'ajustement en hauteur, couvercle en plexiglas.
Mesure de chambre sous vide: 36 x 38 x 14 cm, longueur pour soudage: 35 cm, distance : 34 cm, pompe: 10 cbm/h, max. sachet: 35 x 40 cm

Art-Nr./No d'article	Grösse/grandeur	Gewicht/poids	Anschluss/puissance	Preis/prix
8270.90440	40 x 50 cm x H 36 cm	40 kg	230 V / 0,63 kW	4458.55



T15

**«Plusvac 20»
Vakuum-Verpackungsmaschine
Appareil   emballer sous vide**

Made in Germany, Komplet aus Edelstahl, Hochleistungs-Vakuumpumpe, Vakuumstoptaste, Elektronische Steuerung, Breite Doppelschweissung, Einlegeplatten zur Höhenverstellung, gew lbter Plexiglasdeckel.
Kammergrösse: 43 x 50,5 x 17,5 cm, Schweissl nge: 40,5 cm, Distanz: 45,5 cm, Pumpe: 21 cbm/h, max. Beutel: 40 x 50 cm
Fabriqu  en Allemagne, en inox, pompe   sous vide   haut d bit, touche d'arr t de sous vide, contr le  lectronique, plaques d'insertion pour l'ajustement en hauteur, couvercle en plexiglas.
Mesure de chambre sous vide: 43 x 50,5 x 17,5 cm, longueur pour soudage: 40,5 cm, distance: 45,5 cm, pompe: 21 cbm/h, max. sachet: 40 x 50 cm

Art-Nr./No d'article	Grösse/grandeur	Gewicht/poids	Anschluss/puissance	Preis/prix
8270.90430	48 x 65,5 cm x H 38,5 cm	70 kg	400 V / 1 kW	5289.00



T15

**Ausf hrung «perfect»
Ex cution «perfect»**

Made in Germany, Komplet aus Edelstahl, Hochleistungs-Vakuumpumpe, Vakuumstoptaste, sensorgesteuerte Elektronik, Breite Doppelschweissung, Einlegeplatten zur Höhenverstellung, gew lbter Plexiglasdeckel.
Kammergrösse: 43 x 50,5 x 17,5 cm, Schweissl nge: 40,5 cm, Distanz: 45,5 cm, Pumpe: 21 cbm/h, max. Beutel: 40 x 50 cm
Fabriqu  en Allemagne, en inox, pompe   sous vide   haut d bit, touche d'arr t de sous vide, avec  lectronique command  par capteur, plaques d'insertion pour l'ajustement en hauteur, couvercle en plexiglas.
Mesure de chambre sous vide: 43 x 50,5 x 17,5 cm, longueur pour soudage: 40,5 cm, distance: 45,5 cm, pompe: 21 cbm/h, max. sachet: 40 x 50 cm

Art-Nr./No d'article	Grösse/grandeur	Gewicht/poids	Anschluss/puissance	Preis/prix
8270.90450	48 x 65,5 cm x H 38,5 cm	70 kg	400 V / 1 kW	5869.00

KÜHLAPPARATE / APPAREILS FRIGORIFIQUES



T13



Kühlaufsatz für 5 x 1/4 GN, 150 mm Présentoir réfrigéré pour 5 x GN 1/4, 150 mm

für GN-Behälter, 150 mm tief, Chromnickelstahl, mit Glasaufsatz, Kälteaggregat mit Kühlwanne, Digitalthermometer, Betriebstemperatur: 0 °C / +10 °C
Lieferung ohne GN-Behälter!
pour bac GN, 150 mm de hauteur, en acier inoxydable, vitrine en verre, compresseur avec cuve réfrigérée, thermomètre digital, Températures de service: 0 °C / +10 °C
Livré sans bacs GN !

Art.-Nr./No d'article	Grösse/grandeur	Gewicht/poids	Anschluss/puissance	Preis/prix
8270.90180	120 x 33,5 x H 42,5 cm	42,5 kg	220-240 V / 0,18 kW	1329.35



T13



Kühlauslagevitrine 67 L, mit 8 GN-Behältern GN 1/6 Présentoir réfrigéré, 67 L

Edelstahlgehäuse, Glasdeckel (Sicherheitsglas), Schneidbrett aus Polyethylen, Statische Kühlung, automatische Abtaufunktion, Betriebstemperatur 0° C bis 10° C, mit 3 GN-Stegen (L 36 cm), inklusive 8 Behälter GN 1/6 100 mm tief
Boîtier en acier inoxydable, couvercle en verre (verre de sécurité), planche à découper en polyéthylène, refroidissement statique, fonction de décongélation automatique, température de fonctionnement 0 °C à 10 °C, avec 3 entretoises GN (L 36 cm), 8 récipients inclus GN 1/6 100 mm de profondeur

Art.-Nr./No d'article	Grösse/grandeur	Gewicht/poids	Anschluss/puissance	Preis/prix
8270.90182	76,5 x 61 x H 33 cm	25,7 kg	230 V / 0,07 kW	1694.05

KÜHLAPPARATE / APPAREILS FRIGORIFIQUES



T13

Kühlvitrine
Vitrine réfrigérée

Tragstruktur aus CNS, Umluft-Kühlung, beidseitig bedienbar durch Schiebetüren, Doppelverglasung, LED-Beleuchtung, automatischer Abtauprozess, Betriebstemperatur +2 bis +12° C

Structure porteuse en acier CNS, refroidissement par air pulsé, utilisable des deux côtés par portes coulissantes, double vitrage, éclairage LED, processus automatique de décongélation, température de fonctionnement +2 à +12 °C

Art-Nr./No d'article	Grösse/grandeur	Gewicht/poids	Anschluss/puissance	Preis/prix
8270.90270	91 x 51,5 x H 55,5 cm	53 kg	230 V / 0,15 kW	2116.40
8270.90271	111 x 51,5 x H 55,5 cm	58 kg	230 V / 0,23 kW	2341.15
8270.90272	131 x 51,5 x H 55,5 cm	63 kg	230 V / 0,23 kW	2493.85

Zubehör/Accessoires

8270.90273	Rost/grille zu/pour 8270.90270	552 x 390 mm		96.20
8270.90274	Rost/grille zu/pour 8270.90271	752 x 390 mm		104.20
8270.90275	Rost/grille zu/pour 8270.90272	952 x 390 mm		112.30



T13

Mini-Kühlvitrine
Mini vitrine réfrigérée

Umluft-Kühlung, Fassungsvermögen 78 Liter, Betriebstemperatur +2 bis +12° C, mit Beleuchtung

Froid ventilé, contenance: 78 litres, température de service +2 à +12 °C, avec éclairage

Art-Nr./No d'article	Grösse/grandeur	Gewicht/poids	Anschluss/puissance	Preis/prix
8208.00016	42,5 x 38 x H 96 cm	38 kg	230 V / 0,16 kW	822.30



T13

Ice Crusher
Broyeur à glaçons

Edelstahl, Leistung 60 kg/h, mit Vorratsbehälter für 1 kg Eis

Acier inoxydable, production 60 kg/h, avec bac du stockage 1 kg

Art-Nr./No d'article	Grösse/grandeur	Gewicht/poids	Anschluss/puissance	Preis/prix
8270.90102	17,3 x 38 x H 38,5 cm	14 kg	230 V / 0,06 kW	1173.95



T13



**Eiswürfelbereiter
Appareils à glaçons**

Luftgekühlt, Paddelsystem, die Eisproduktion ist einfach und zuverlässig, selbst bei hohen Wasserhärtegraden braucht man kein Filtersystem, Tagesleistung: 25 kg, Vorratsbehälter: 8 kg, Festwasseranschluss: 3/4", Wasserablauf: Ø 24 mm, Füße + 5 mm

Refroidissement par air, système à pagayes, le système de production à pagayes est simple et sûr, avec une eau très calcaire ces appareils ne nécessitent pas de filtres spécifiques, production journalière: 25 kg, Stockage: 8 kg, raccordement eau: 3/4", écoulement: Ø 24 mm, Pieds +5 mm

Art.-Nr./No d'article	Grösse/grandeur	Gewicht/poids	Anschluss/puissance	Preis/prix
8270.90096	46,8 x 38,5 x H 68,7 cm	38 kg	230 V / 0,3 kw	2939.75

**STETIGE REINIGUNG
UNERLÄSSLICH!
NETTOYAGE RÉGULIER
PRIMORDIAL!**



T13



**Schockfroster - 5 x GN 1/1
Refroidisseur rapide - 5 x GN 1/1**

Edelstahl, Umluftkühlung, inkl. Kerntemperaturfühler, Behälterformat GN 1/1 oder 600 x 400, Abstand zwischen den Einschüben 70 mm, Schnellkühlzyklus: +70°C bis +3°C: 16 kg in 90 Minuten, Schockfrostatzyklus: +70°C bis -18°C: 12 kg in 240 Minuten

Acier inoxydable, refroidissement par air pulsé, format de récipient GN 1/1 ou 600 x 400, distance entre les inserts 70 mm, cycle de refroidissement rapide: +70 °C à +3 °C: 16 kg en 90 minutes, cycle de choc thermique: +70 °C à -18 °C: 12 kg en 240 minutes, sonde de température à coeur incl.

Art.-Nr./No d'article	Grösse/grandeur	Gewicht/poids	Anschluss/puissance	Preis/prix
8270.90097	75 x 70 x H 85 cm	98 kg	230 V / 1,2 kW	5869.00



T13



**Tiefkühlschrank für Spirituosen und TK-Ware
Congélateur pour les spiritueux et les produits surgelés**

Bruttoinhalt: 30 Liter, Fassungsvermögen: 8 Flaschen (0,7l), stehend, 3 Flaschen (0,7l), liegend, Temperaturbereich: -15°C bis -25°C, Kühlmittel R600a
Capacité brute : 30 litres, contenance: 8 bouteilles (0.7 l) debout, 3 bouteilles (0.7 l) couchées, gamme de température : -15°C à -25°C, réfrigérant R600a

Art.-Nr./No d'article	Grösse/grandeur	Gewicht/poids	Anschluss/puissance	Preis/prix
8208.00030	47 x 44,5 x H 49,2 cm	16,85 kg	230 V / 0,06 kW	423.50

BARMASCHINEN / MACHINES DU BAR



T13



HAMILTON BEACH Elektrische Zitruspresse Presse citron électrique

Metallgehäuse mit säureresistentem Finish, extra grosser Edelstahlbehälter, Sieb- und Presskopfaufsatz aus Polycarbonat, mit on/off PUSH-Knopf, 3 verschiedene Presskopfeinsätze gebogene Frontpartie zur optimalen Platzierung verschiedener Gefässe (vom Saftglas bis zur Karaffe)

Boîtier en métal résistant à l'acidité, très grand récipient en acier inox, tamis et partie supérieure en polycarbonate, avec bouton pression on/off, 3 éléments de presse, partie frontale recourbée pour le placement optimal de différents récipients (du verre à jus à la carafe).

Geeignet für Zitronen-, Orangen-, Grapefruitsaft
Convient parfaitement pour les jus de citron, orange et grapefruit

Art-Nr./No d'article
8649.00000

Anschluss/puissance
0,3 kW

Preis/prix
1779.85



T13



HAMILTON BEACH Bar Blender Mixeur pour bar

2 Geschwindigkeiten, Kunststoff-Kupplung, inkl. 1,3 L Lexan-Becher
2 vitesses, coupleur en matière plastique, gobelet Lexan de 1,3 l inclus

Geeignet für Cocktails, Margaritas, Icekaffees, kalte Getränke.
Eignet sich zum Mixen von Drinks mit vorher gecrushtem Eis.
Nicht geeignet zum Eiscrushen.

Convient pour cocktails, margaritas, cafés glacés, boissons froides, milkshakes, mousse d'œufs.

*Convient également pour mixer les boissons avec de la glace pilée.
Ne convient pas pour piler la glace.*

Art-Nr./No d'article
8649.00001

Anschluss/puissance
3/8 PS - 0,4 kW

Preis/prix
378.80



T13



HAMILTON BEACH
Rio Bar Blender
Mixeur pour le Bar «Rio»

2 Geschwindigkeiten, Puls-Funktion, 1,6 PS, mit «Wave Action Technology™», Deckel-offen-Sensor, Metall-Kupplung, inkl. 1,4 L Becher aus Tritan Copolyester
2 vitesses, fonction Pulse, 1,6 CV, avec «Wave Action Technology™», capteur de couvercle ouvert, coupleur métallique, gobelet de 1,4 L en copolymère de tritan inclus

Geeignet für Cocktails, Margeritas, Icekaffees, kalte Getränke.
Eignet sich zum Mixen von Drinks mit vorher gecrushtem Eis.
Nicht geeignet zum Eiscrushen.
Convient pour cocktails, margeritas, cafés glacés, boissons froides, milkshakes.
Convient également pour mixer les boissons avec de la glace pilée. Ne convient pas pour piler la glace.

Art-Nr./No d'article	Grösse/grandeur	Anschluss/puissance	Preis/prix
8649.00005	190 x 216 x 410 mm	230 V	822.30



T13



HAMILTON BEACH
Rio Bar Blender Inox
Mixeur pour le Bar «Rio», Inox

2 Geschwindigkeiten, Puls-Funktion, 1,6 PS, mit «Wave Action Technology™», Deckel-offen-Sensor, Metall-Kupplung, inkl. 0,95 L Becher aus Edelstahl
2 vitesses, fonction Pulse, 1,6 CV, avec «Wave Action Technology™», capteur de couvercle ouvert, coupleur métallique, gobelet de 0,95 L en inox inclus

Geeignet für Cocktails, Margeritas, Icekaffees, kalte Getränke.
Eignet sich zum Mixen von Drinks mit vorher gecrushtem Eis.
Nicht geeignet zum Eiscrushen.
Convient pour cocktails, margeritas, cafés glacés, boissons froides, milkshakes.
Convient également pour mixer les boissons avec de la glace pilée. Ne convient pas pour piler la glace.

Art-Nr./No d'article	Anschluss/puissance	Anschluss/puissance	Preis/prix
8649.00006	190 x 216 x 430 mm	230 V	894.05



T13



Drink-Mixer
Mixeur à boissons

Ideal für die Zubereitung von Cocktails, Milchshakes, Smoothies, Saucen, Püree etc.

Gehäuse Stahlblech lackiert, Becher, Mixstab und Mixscheiben aus Edelstahl, 2 Geschwindigkeitsstufen, 1 Mikroschalter am Behereinschub, Kippsicher durch Saugnäpfe, Mixbecher: Inhalt 950 ml, Füllmenge: max. 650 ml, Mixbecher und Mixstab spülmaschinengeeignet

Idéal pour la préparation de cocktails, milkshakes, smoothies, sauces, purée etc. Habillage: tôle d'acier laquée, bol, bras mixeur et couteau en inox, 2 vitesses, 1 micro-interrupteur à l'insertion de bol, Bol : contenance 950 ml, capacité : 650 ml max., Bol et bras mixeur en supportant nettoyage en machine

Art-Nr./No d'article	Grösse/grandeur	Anschluss/puissance	Preis/prix
8270.90175	16 x 20,5 x H 50 cm / 6,22 kg	230 V / 0,4 kW	411.70

RACLETTE / RACLETTE



Raclettemesser Couteau à raclette

in Holzetui mit Kisseneinlage
en étui en bois avec coussin

Art-Nr./No d'article Grösse/grandeur
8179.00008 25 cm

Preis/prix
38.20



«Easy-Gas» Raclette Raclette

für einen 1/2 Käselaub rund, Käsehalter auf Schwenkarm, Inkl. Rucksack, Druckregler und Adapter für Gasbehälter nicht mitgeliefert. Lieferung ohne Gaskartusche.

pour 1/2 de meule ronde, porte-frommage sur bras pivot, incl. sac à dos, détendeur variable avec tuyau haute pression et robinet-relais pour bouteille Camping Gaz non inclus. Livraison sans cartouche de gaz.

Art-Nr./No d'article Grösse/grandeur Gewicht/poids
8179.00021 43 x 28 x H 32 cm 8 kg 2 - 2,5 kW

Preis/prix
564.65

Zubehör/Accessoires

8179.00022 Variabler Druckregler mit Hochdruckschlauch
Détendeur variable avec tuyau haute pression

139.90

8179.00023 Adapter für Camping Gas Flaschen
Robinet-relais pour bouteille Camping Gaz

81.15



T13



**«Racletta»
Raclette
Raclette**

für Käsestücke, Käsehalter auf Schwenkarm
pour un bloc de fromage, porte-fromage sur bras pivot

Art-Nr./No d'article	Grösse/grandeur	Gewicht/poids	Anschluss/puissance	Preis/prix
8179.00003	31 x 19 cm x H 26 cm	3 kg	230/115 V / 600 W	272.90



T13



**«Pop»
Raclette
Raclette**

für einen 1/2 Käse laib rund, Käsehalter auf Schwenkarm
pour 1/2 de meule ronde, porte-fromage sur bras pivot

Art-Nr./No d'article	Grösse/grandeur	Gewicht/poids	Anschluss/puissance	Preis/prix
8179.00002	55 x 29 x H 38 cm	7 kg	230/115 V / 1 kW	312.90



T13



**«DS 2000»
Raclette
Raclette**

für 1 oder 2 halbe Käse laib rund
pour 1 ou 2 demi-meules rondes

Art-Nr./No d'article	Grösse/grandeur	Gewicht/poids	Anschluss/puissance	Preis/prix
8179.00004	53 x 28 x H 32 cm	7 kg	230/115 V / 1 kW	378.80

ROLLMATERIAL 630

Transportwagen/Servierwagen
 Tablettwagen
 Regalwagen
 Tellerstapler

ROLLMATERIAL ELEKTRISCH 645

Stapelgeräte

CALDO CASA 647**SPEISETRANSPORT 650**

BLU'BOX
 Speisentransportbehälter
 Isobox
 Frühstückswagen
 Speiseausgabewagen
 Bankettwagen/Tablett-Transportwagen

SPÜLKÖRBE 667

Tellerkörbe/Besteckkörbe/Tablettkörbe
 Transportwagen
 Gläserkörbe

CATERING TRANSPORTBOXEN 678

Separationen
 Glas Manager
 Eurobehälter RAKO
 Transportroller
 Geschirrtransportbox

REINIGUNG 685

Kehrschaufelset
 Reinigungsmittel
 Abfallbehälter
 Etagenwagen

HYGIENE 700

Mobiles Handwaschbecken
 Desinfektionsmittel-Spender

REGALE 704**MATÉRIEL ROULANT 630**

Chariot de transport/de service
 Chariot à plateaux
 Chariot à glissières
 Chariot à assiettes

MATÉRIEL ROULANT ÉLECTRIQUE 645

Chariots distributeurs

CALDO CASA 647**TRANSPORT D'ALIMENTS 650**

BLU'BOX
 Bac de transport pour aliments
 Isobox
 Chariot de petit-dejeuner
 Chariots bain-marie
 Chariot banquet/de transport plateaux

CORBEILLES DE LAVAGE 667

Corbeilles pour assiettes/plateaux/couverts
 Chariot de transport
 Corbeilles pour verre

BOX DE TRANSPORT P. CATERING 678

Séparations
 Manager de verre
 Bac RAKO
 Chariots pour box
 Box de transport de vaisselle

NETTOYAGE 685



Set de pelle
 Produit de nettoyage
 Poubelles
 Table de service

HYGIÈNE 700

Lave-mains mobile
 Distributeur de désinfectant

RAYONNAGE 704

TRANSPORT & REINIGUNG TRANSPORT ET NETTOYAGE

	Schwarze Artikelnummern: Numéros de référence noirs:	Lagerartikel (Zwischenverkauf vorbehalten) article en stock (sous réserve de vente intermédiaire)
	Grüne Artikelnummern: Numéros de référence verts:	Lieferzeit 2 bis max. 4 Wochen délai de livraison 2 à max. 4 semaines
	Rote Artikelnummern: Numéros de référence rouges:	Lieferzeit 4 bis max. 12 Wochen (Sonderanfertigungen) délai de livraison 4 à max. 12 semaines (réalisations spéciales)

Bei Lieferfristen von über 12 Wochen werden Sie informiert.
En cas de livraison de plus de 12 semaines, vous serez informés.

ROLLMATERIAL / MATÉRIEL ROULANT



Servierwagen mit montierter Verkleidung inkl. Flügeltüre Chariot de service avec revêtement et porte frontale

Art-Nr./No d'article	Aussenmasse/Dimensions	Borde/niveaux	Farbe/Couleur	
8220.000xx	90 x 60 x H 95 cm	2	Farbe/Couleur	988.00
8220.001xx	90 x 60 x H 95 cm	3	Farbe/Couleur	1164.40
8220.10000	90 x 60 x H 95 cm	2	Inox	1458.55
8220.10100	90 x 60 x H 95 cm	3	Inox	1644.75

Dreiseitige Aussenverkleidung zum einfachen Einklicken in Selbstmontage Revêtement extérieur 3 côtés pour faciliter le montage

Für bestehende oder neue Blanco Servierwagen SW 8x5, 2-Bordig und 3-Bordig
Convient aux chariots Blanco SW 8x5, 2 ou 3 niveaux, existants ou nouveaux

Art-Nr./No d'article	Farbe/Couleur	
8220.200xx	Farbe/Couleur	435.05
8220.20000	Inox	552.70

Dreiseitige Aussenverkleidung plus frontseitige Türe mit Magnetsicherung. Revêtement extérieur 3 côtés plus porte frontale avec arrêt de sûreté aimanté

Selbstmontage nur mit handwerklichen Fähigkeiten möglich.
Für bestehende oder neue Blanco Servierwagen SW 8x5, 2-Bordig und 3-Bordig
Montage par soi-même, uniquement avec des aptitudes manuelles.
Convient aux chariots Blanco SW 8x5, 2 ou 3 niveaux, existants ou nouveaux

Art-Nr./No d'article	Farbe/Couleur	
8220.300xx	Farbe/Couleur	586.80
8220.30000	Inox	822.10

Servierwagen ohne Verkleidung Chariot de service sans revêtement

Art-Nr./No d'article	Aussenmasse/Dimensions	Borde/niveaux	
8220.40000	90 x 60 x H 95 cm	2	435.05
8220.50000	90 x 60 x H 95 cm	3	469.20

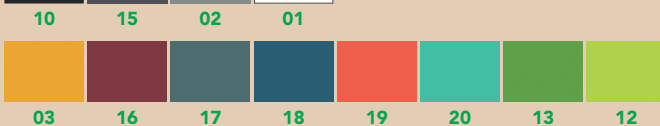

FERTIG MONTIERT
PRÊT ASSEMBLÉ

HUPFER



**Transportwagen
Chariot de service**

Die Transportwagen von Hupfer sind aus Edelstahl und dadurch besonders hygienisch und stabil. Die eingeschweissten und tiefgezogenen Borde haben ein ringsum laufenden, erhöhten Profilrand. Mit den vier Lenkrollen ist der Wagen besonders mobil und ideal für den häufigen Gebrauch. Die eingebauten Rollen haben zwei Totalfeststeller.

Les chariots de service de Hupfer en acier inoxydable sont donc particulièrement hygiéniques et stables. Les étagères soudées et emboutis ont un bord surélevé sur tout leur pourtour. Grâce à ses quatre roulettes pivotantes, le chariot est particulièrement mobile et idéal pour une utilisation fréquente. Les roulettes intégrées ont deux freins.

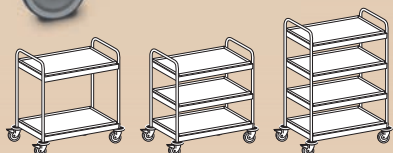

0124002
0111932
0112052

0124012
0111962
0112082

0111992

Art-Nr./No d'article	Aussenmasse/Dimensions	Borde/niveaux	Bordmass/Dimension	Preis/prix
0124002	70 x 50 cm x H 89,4 cm	2	60 x 40 cm	529.15
0124012	70 x 50 cm x H 89,4 cm	3	60 x 40 cm	586.80
0111932	90 x 60 cm x H 94,7 cm	2	80 x 50 cm	469.20
0111962	90 x 60 cm x H 94,7 cm	3	80 x 50 cm	586.80
0111992	90 x 60 cm x H 126 cm	4	80 x 50 cm	939.05
0112052	109,5 x 69,5 cm x H 96 cm	2	100 x 60 cm	682.10
0112082	109,5 x 69,5 cm x H 96 cm	3	100 x 60 cm	798.75

FERTIG MONTIERT
PRÊT ASSEMBLÉ

HUPFER



**Transportwagen mit Pneurollen
Chariot de transport avec roulettes pneus**

Die Transportwagen von Hupfer sind aus Edelstahl und dadurch besonders hygienisch und stabil. Die eingeschweissten und tiefgezogenen Borde haben ein ringsum laufenden, erhöhten Profilrand. Mit den vier Lenkrollen ist der Wagen besonders mobil und ideal für den häufigen Gebrauch. Luftidentische und pannensichere Pneurollen. Dieser Rollentyp sorgt für minimale Fahrgeräusche und ist besonders für unebene Fahrwege geeignet.

Les chariots de service de Hupfer en acier inoxydable sont donc particulièrement hygiéniques et stables. Les étagères soudées et emboutis ont un bord surélevé sur tout leur pourtour. Grâce à ses quatre roulettes pivotantes, le chariot est particulièrement mobile et idéal pour une utilisation fréquente. Avec roulettes pneus increvables et gonflage identique. Ce type de roulettes assure un bruit de déplacement minimal et est particulièrement adapté pour les surfaces non lisses.

mit Pneurollen
avec roulettes pneu

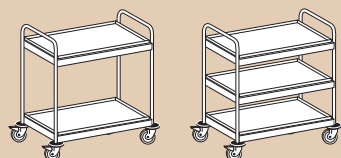

0163527

0163325



Art-Nr./No d'article	Aussenmasse/Dimensions	Borde/niveaux	Bordmass/Dimension	Preis/prix
0163527	90 x 60 cm x H 94,7 cm	2	80 x 50 cm	517.40
0163325	90 x 60 cm x H 94,7 cm	3	80 x 50 cm	586.80

HUPFER

Servierwagen mit Aufsatz für Besteckboxen
Chariot de service avec rehausse pour casiers à couverts

Mobile Bestecksortierstation zum Einhängen von Besteckboxen. Servierwagen komplett aus hochwertigem Edelstahl. Lieferumfang ohne Boxen.
 Station à triage de couverts mobile pour accrocher des casiers à couverts.
 Chariot complet en acier inoxydable d'haute qualité. Contenu de livraison sans casiers.

Aufsatz zu Servierwagen
Rehausse pour casiers

Art-Nr./No d'article	Kapazität Besteckboxen/capacité de charge de casiers	Preis/prix
0111900	6	305.60

Servierwagen
Chariot de service

Art-Nr./No d'article	Aussenmasse/Dimensions	Borde/niveaux	Bordmass/Dimension	Preis/prix
0111932	90 x 60 cm x H 94,7 cm	2	80 x 50 cm	469.20
0111962	90 x 60 cm x H 94,7 cm	3	80 x 50 cm	586.80

Servierwagen mit Pneurollen
Chariot de service avec rouleaux en air identiques

Art-Nr./No d'article	Aussenmasse/Dimensions	Borde/niveaux	Bordmass/Dimension	Preis/prix
0163527	90 x 60 cm x H 94,7 cm	2	80 x 50 cm	517.40
0163325	90 x 60 cm x H 94,7 cm	3	80 x 50 cm	586.80

HUPFER

Besteckbehälter GN 1/3
Collecteur de couverts GN 1/3

Edelstahl, mit Anhängervorrichtung für Servierwagen
 Inox, avec 2 crochets pour accrocher au chariot de transport ou de service

Art-Nr./No d'article	Grösse/grandeur	Preis/prix
0116202	32,5 x 17,6 x H 15 cm	164.45

HUPFER

Abfallbehälter
Collecteur de déchets

Edelstahl, mit Anhängervorrichtung für Servierwagen
 Inox, avec 2 crochets pour accrocher au chariot de transport ou de service

Art-Nr./No d'article	Grösse/grandeur	Preis/prix
0116192	42 x 20 x H 25 cm	305.60

 **Fertig montiert**
prêt assemblé



Caldomet Geschirr- und Gläserwagen CGW Chariot à vaisselle et verres CGW Caldomet

Der perfekt entwickelte Wagen zum Lagern und Servieren von Frühstücksgeschirr. Konzipiert für 125 Gedecke (Teller, Tasse, Untertasse und Besteck).

Der Wagen aus voll verschweisstem CNS 18/10 ist ausgestattet mit:

- 1 seitlicher Auszug für 4 Stk. Besteckbehälter (Besteckbehälter nicht inbegriffen).
- 4 Stk. verzinkte Vollauszüge für Drahtkörbe in Euro-Norm-Abmessung (Körbe nicht inbegriffen) für die Geschirrtile.
- 5 Stk. verzinkte Vollauszüge für Kunststoffkörbe 500 x 500 x 140 mm (Körbe nicht inbegriffen) für Tassen oder Gläser. Die Vollauszüge können mit einem herausnehmbaren CNS-Einlegeblech ausgestattet werden (optional). Die Abstellfläche oben ist mit einer 3-seitig geschweissten Aufkantung, 15 mm hoch, versehen. 4 Lenkrollen Ø 100mm, 2 davon mit Feststellbremse für einfaches und sicheres Manövrieren. Der Wagen hat stirnseitig einen ergonomisch runden Handgriff aus CNS.

Le chariot développé à la perfection pour le stockage et le service de la vaisselle de petit-déjeuner (assiettes, tasses, sous-tasses et couverts).

Le chariot est entièrement soudé en acier inox 18/10 et contient:

- 1 cuve coulissante pour 4 bacs à couverts (bacs non-compris dans l'équipement).
- 4 cuves coulissantes zinguées pour paniers EN à vaisselle (paniers non-compris).
- 5 cuves coulissantes zinguées pour paniers (paniers non-compris) à tasses et à verres 500 x 500 x 140 mm. Les cuves peuvent être équipées d'une plaque en inox (en option). La surface supérieure est entourée sur trois côtés d'un bord relevé soudé 15 mm. 4 roues directrices 100 mm Ø, dont 2 avec freins pour facilement manoeuvrer. Équipé avec une barre de guidage ronde, ergonomique en acier inox.

Art-Nr./No d'article Grösse/grandeur
600049101 1055 x 625 x 940 mm

Preis/prix
5875.00



Einlage-/Abtropfblech Egouttoir

CNS

mit Winkel

Art-Nr./No d'article Grösse/grandeur
600098101 505 x 505 x 30 mm

Preis/prix
234.00

ohne Winkel

Art-Nr./No d'article Grösse/grandeur
600099101 505 x 505 x 30 mm

Preis/prix
211.50

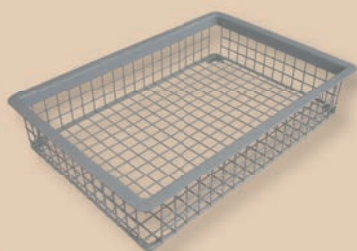

Einschubkorb Euro-Norm Corbeilles Euro-Norm EN

rlsaniert, Innenmass 490 x 330 x 95 mm
mesures intérieures 490 x 330 x 95

Art-Nr./No d'article
640274237

Preis/prix
257.45

HUPFER

Euronormkisten-Regaltransportwagen
Etagère roulante pour bacs au format Euronorm

Edelstahl, inkl. 4 geschlossenen Auflagen (1300 x 600 mm), 4 Lenkrollen, davon 2 mit Totalfeststeller, Ø 125 mm. Die Auflagen können in einem Raster von 75 mm eingehängt werden und jederzeit ohne Werkzeug in der Höhe verstellt, ausgetauscht oder entnommen werden.

Inox, incl. 4 supports fermé (1300 x 600 mm), 4 roues directrices, dont 2 avec freins, Ø 125 mm Les supports sont positionnables sur le cadre tous les 75 mm et à tout moment ils peuvent être déplacés en hauteur, remplacés ou supprimés, ceci sans outil.

Art-Nr./No d'article	Grösse/grandeur	Kapazität/capacité	Preis/prix
0123099	137,5 x 67,5 x H 165,2 cm	4 x 3 RAKO (600 x 400 mm)	1881.05

Lieferung ohne Behälter!
 Livré sans contenant!

HUPFER

Kommissionierwagen für Eurobehälter
Chariot à glissières pour bacs au format Euronorm

Transportwagen aus hochwertigem Edelstahl in selbsttragender, hygienischer und verschweisster Bauweise für Kommissionierung und Transport grosser Warenmengen im Lagerbereich.

Chariot de transport en acier inoxydable de qualité dans une construction auto-portante, hygiénique et soudée pour la préparation et le transport de grandes quantités de marchandises en entrepôt.

Art-Nr./No d'article	Grösse/grandeur	Preis/prix
0163798	69,4 x 96,9 x H 171,1 cm	3516.40

Lieferung ohne Behälter!
 Livré sans contenant!

HUPFER



0123102



0123103

0123104

Regaltransportwagen für Eurobehälter
Chariot de transport pour bacs Euronorm

Edelstahl, teilmontiert, ohne Auflagen (passend für 1-5 Drahtauflagen),
4 Lenkrollen, davon 2 mit Totalfeststeller, Ø 125 mm
Inox, sans supports (convenant à 1-5 tablettes en fil métallique),
4 roues directrices, dont 2 avec freins, Ø 125 mm

Art-Nr./No d'article	Grösse/grandeur	Kapazität/capacité	Preis/prix
0123103	57 x 67 x H 185,5 cm	1 x RAKO (600 x 400 mm)	1324.25
0123104	107 x 67 x H 185,5 cm	2 x RAKO (600 x 400 mm)	1458.55
0123102	147 x 67 x H 185,5 cm	3 x RAKO (600 x 400 mm)	1527.05

Lieferung ohne Behälter!
Livré sans contenant!

HUPFER



0164173



0164171

0164172

Drahtrostauflage für Eurobehälter
Tablettes en fil métallique pour bacs aux Euronorm

Drahtauflage zum schrägen Einhängen in Regalständer
Tablettes en fil métallique pouvant être ajustées en biais dans l'étagère

Art-Nr./No d'article	Grösse/grandeur	Kapazität/capacité	Preis/prix
0164171	50 x 60 cm	1 x RAKO (600 x 400 mm)	141.10
0164172	100 x 60 cm	2 x RAKO (600 x 400 mm)	258.55
0164173	140 x 60 cm	3 x RAKO (600 x 400 mm)	317.40

Lieferung ohne Behälter!
Livré sans contenant!

HUPFER

Produktionswagen für Eurobehälter
Chariot pour bacs au format Euronorm

Der Produktionswagen für Eurobehälter ist als leichter, kleiner und wendiger Wagen besonders geeignet für den Einsatz in engen Produktionsbereichen und für die Kommissionierung kleinerer Mengen.

En tant que chariot léger, petit et maniable, le chariot de production pour Euro-conteneurs est particulièrement adapté pour une utilisation dans des espaces de production exigus et pour la préparation de petites quantités.

Art-Nr./No d'article Grösse/grandeur
0163610 53,9 x 70,2 x H 153 cm

Preis/prix
988.00

Lieferung ohne Behälter!
 Livré sans contenant!

HUPFER

Korbroller für Eurobehälter mit Griff
Chariot pour bacs au format Euronorm avec anse

Edelstahl, 4 Lenkrollen, davon 2 mit Totalfeststeller, Ø 125 mm
 Inox, 4 roues pivotantes, dont 2 avec freins, Ø 125 mm

Art-Nr./No d'article Grösse/grandeur
0164183 80 x 48 x H 102,5 cm

Preis/prix
764.45

Lieferung ohne Behälter!
 Livré sans contenant!

HUPFER

Korbroller für Eurobehälter ohne Griff
Chariot pour bacs au format Euronorm sans anse

Edelstahl, 4 Lenkrollen, davon 2 mit Totalfeststeller, Ø 125 mm
 Inox, 4 roues pivotantes, dont 2 avec freins, Ø 125 mm

Art-Nr./No d'article Grösse/grandeur
0164174 63 x 43 cm x H 19 cm

Preis/prix
329.15

TAWALU

Ihr individueller Tablett-Abbräumwagen
Votre chariot à débarrasser individuel

Offerte
Offre

Bestellung
Commande

Stückzahl/quantité

HUPFER

GRUNDMODELL:
MODÈLE DE BASE:

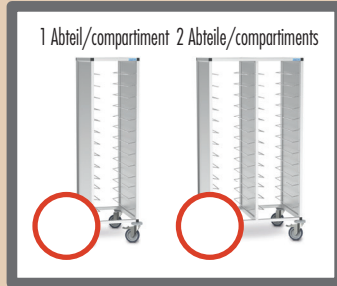

WAGENFARBE:
COULEUR DE CHARIOT:

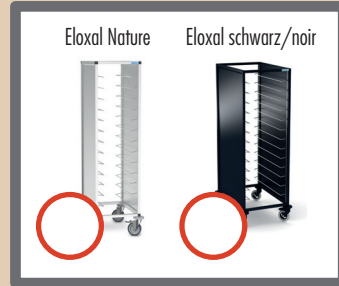

ROLLEN:
ROULETTES:



TABLETTART PRO EINSCHUBFACH FESTLEGEN:
SÉLECTIONNEZ LE TYPE DE PLATEAUX PAR GLISSIÈRE:

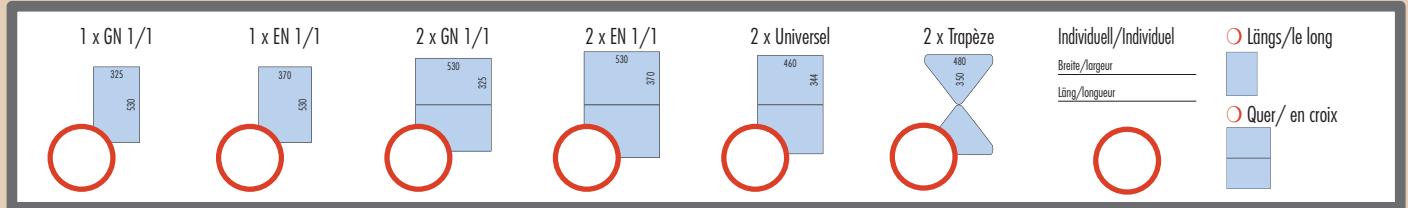

ABSTAND DER AUFLAGESCHIENEN (PRO FACH):
L'ESPACEMENT DES GLISSIÈRES (PAR COMPARTIMENT):



WAGENHÖHE:
HAUTEUR DE CHARIOT:

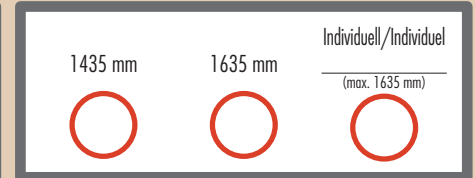

FARBE UND DEKOR AUSWÄHLEN:
SÉLECTIONNEZ LE DÉCOR ET LA COULEUR:



AUSSTATTUNG WÄHLEN:
SÉLECTIONNEZ L'ÉQUIPEMENT:

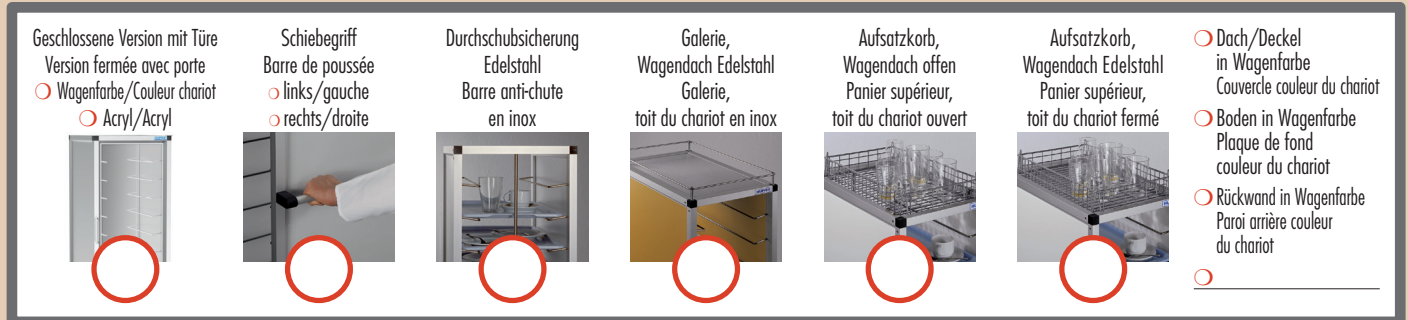

Notiz

**FERTIG MONTIERT
PRÊT ASSEMBLÉ**

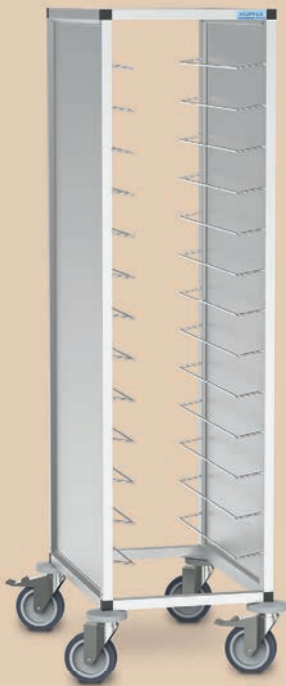

HUPFER

**TAWALU
Tablett-Abräumwagen, 1 Abteil
Chariot à débarrasser, 1 compartiment**

für GN 1/1 Tablett, Längseinschub, Tablettabstand: 125 mm.
pour plateaux GN 1/1, tiroir longitudinal, distance entre les plateaux 125 mm.

Tablett-Abräumwagen zum Einschub und Transport von Tablett mit Schmutzgeschirr. Wagen in stabiler und hygienischer Rohrrahmen-Konstruktion aus eloxiertem Aluminium mit Verbindungselementen aus Kunststoff und fest eingesetzten Seitenwänden in verschiedenen Dekoren. Fest mit dem Rohrrahmen verbundene Tablettauflagen aus Edelstahl-Vollmaterial, ø 6 mm, mit beidseitiger Durchschubsicherung. Vier Abweiserrollen aus Polymer dienen als Anfahrerschutz, schützen sowohl den Wagen rundum als auch bauseitige Wände besonders effektiv vor Beschädigungen. Wagen fahrbar auf 4 Lenkrollen ø 125 mm mit Rückenlochbefestigung, davon 2 mit Totalfeststellern.

Chariot de déblayage de plateaux pour insérer et transporter des plateaux contenant de la vaisselle sale. Chariot en construction de cadre tubulaire en aluminium anodisé stable et hygiénique avec éléments de raccordement en plastique et parois latérales solides avec différentes décorations. Supports de plateaux solidement arrimés au cadre tubulaire en acier inoxydable massif de ø 6 mm, avec barre anti-chute des deux côtés. Quatre roulettes pivotantes en polymère pour protéger efficacement des collisions et des dommages aussi bien le chariot que les murs. Chariot mobile sur 4 roues directrices de Ø 125 mm avec un trou de fixation par vis, dont 2 avec des freins d'arrêt.

Art-Nr./No d'article	Aussenmasse/Dimensions	Kapazität/Capacité	Preis/prix
0222014-N	46 x 68,7 cm x H 1635 cm	10 x GN 1/1	1175.00

Dies ist ein Beispielmodell, denn der TAWALU lässt sich ganz individuell nach Ihren Anforderungen konfigurieren. Beachten Sie die nachfolgende Seite.
Il s'agit d'un modèle d'exemple, car le TAWALU peut être configuré individuellement en fonction de vos besoins. Veuillez consulter la page suivante.

**FERTIG MONTIERT
PRÊT ASSEMBLÉ**

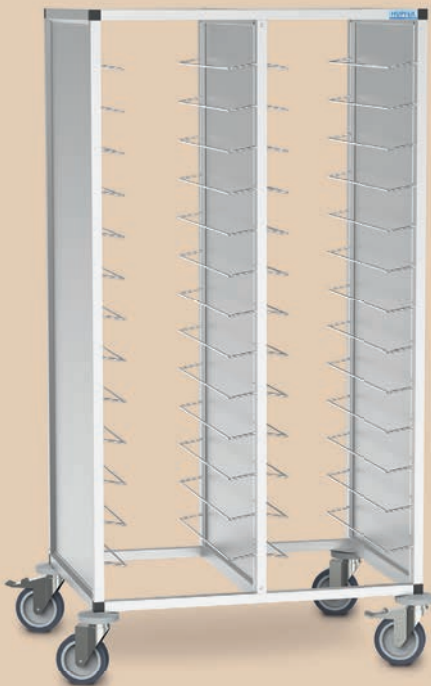

HUPFER

**Tablett-Abräumwagen, 2 Abteile
Chariot à débarrasser, 2 compartiments**

für GN 1/1 Tablett, Längseinschub, Tablettabstand: 125 mm.
pour plateaux GN 1/1, tiroir longitudinal, distance entre les plateaux 125 mm.

Tablett-Abräumwagen zum Einschub und Transport von Tablett mit Schmutzgeschirr. Wagen in stabiler und hygienischer Rohrrahmen-Konstruktion aus eloxiertem Aluminium mit Verbindungselementen aus Kunststoff und fest eingesetzten Seitenwänden in verschiedenen Dekoren. Fest mit dem Rohrrahmen verbundene Tablettauflagen aus Edelstahl-Vollmaterial, ø 6 mm, mit beidseitiger Durchschubsicherung gemäß DIN EN 18867-2. Vier Abweiserrollen aus Polymer dienen als Anfahrerschutz, schützen sowohl den Wagen rundum als auch bauseitige Wände besonders effektiv vor Beschädigungen. Wagen fahrbar auf 4 Lenkrollen ø 125 mm mit Rückenlochbefestigung, davon 2 mit Totalfeststellern.

Chariot de déblayage de plateaux pour insérer et transporter des plateaux contenant de la vaisselle sale. Chariot en construction de cadre tubulaire en aluminium anodisé stable et hygiénique avec éléments de raccordement en plastique et parois latérales solides avec différentes décorations. Supports de plateaux solidement arrimés au cadre tubulaire en acier inoxydable massif de ø 6 mm, avec barre anti-chute des deux côtés selon DIN EN 18867-2. Quatre roulettes pivotantes en polymère pour protéger efficacement des collisions et des dommages aussi bien le chariot que les murs. Chariot mobile sur 4 roues directrices de Ø 125 mm avec un trou de fixation par vis, dont 2 avec des freins d'arrêt.

Art-Nr./No d'article	Aussenmasse/Dimensions	Kapazität/Capacité	Preis/prix
0222165-N	82 x 68,7 cm x H 1635 cm	26 x GN 1/1	1763.30

Dies ist ein Beispielmodell, denn der TAWALU lässt sich ganz individuell nach Ihren Anforderungen konfigurieren. Beachten Sie die nachfolgende Seite.
Il s'agit d'un modèle d'exemple, car le TAWALU peut être configuré individuellement en fonction de vos besoins. Veuillez consulter la page suivante.

HUPFER



**Harrassenwagen
Wagon de cagette**

Harrassenwagen aus hochwertigem Edelstahl gefertigt. Er ist fahrbar auf 4 Lenkrollen, davon 2 mit Totalfeststeller. Gesamttragkraft je Wagen 200 kg.
Wagon de cagette en inox de haute qualité. Il est mobile sur 4 rouleaux pivotantes, dont deux avec freins. Charge maximale 200 kg.

Art-Nr./No d'article Grösse/grandeur
0123100 107,5 x 57,5 x H 165,2 cm

Preis/prix
1881.05

HUPFER



**Tablettbräumwagen für Kantinentabletts mit L-Winkeln
Chariot à débarrasser pour plateaux de cantines**

Der Wagen ist für normale Kantinentabletts, 430x330 mm, mit Längseinschub konzipiert. Erhältlich in zwei Varianten, 1-teilig oder 2-teilig mit Kapazität für 9 bzw. 18 Tablett. Tablettabstand: 150 mm. Tablettgrößen: 1x 430x330 mm längs, 2x 210x320 mm quer, 1x GN1/2 265x325 mm quer. Der Wagen ist sehr hochwertig und komplett aus Chrom-Nickelstahl gefertigt. Er wird standardmässig mit schiefergrauen Argolite-Platten ausgestattet. Weitere Farben auf Anfrage erhältlich. Für den Wagen gibt es einen speziellen Federrahmen für unebene Böden, der Erschütterungen vorbeugt.

Le chariot est conçu pour des plateaux standards 430x330 mm à déposer dans le sens de la longueur. Il est disponible en deux variantes: modèle simple pour 9 plateaux ou modèle double pour 18 plateaux. Distance entre les plateaux: 150 mm. Grandeurs des plateaux: 1x 430x330 mm longueur, 2x 210x320 mm largeur, 1x GN1/2 265x325 mm largeur. Le chariot est entièrement fabriqué en acier chrome-nickel avec parois en Argolite gris ardoise. D'autres couleurs sont disponibles sur demande. Spécialement pour les sols irréguliers, il peut être doté d'amortisseurs afin d'assurer un déplacement tout en douceur.

**für Kantinentabletts 430 x 330 mm
pour plateaux de cantines 430 x 330 mm**

Art-Nr./No d'article	Aussenmasse/Dimensions	Abteile/compartiments	Kapazität/capacité	Preis/prix
T0131000	442 x 527 x 1650 mm	1	9	2351.50
T0131001	797 x 527 x 1650 mm	2	18	3057.40

**Federrahmen
Amortisseurs**

Art-Nr./No d'article	passend/pour	Preis/prix
T0131002	T0131000	635.05
T0131003	T0131001	740.00

**FERTIG MONTIERT
PRÊT ASSEMBLÉ**

HUPFER

**Regalwagen mit Arbeitsplatte
Chariot à glissières avec surface de travail**

Vollständig aus Inox
En inox



Der Regalwagen von HUPFER® – ein zentrales Produkt in der gewerblichen Küche. Ganz gleich, ob Bereitstellung oder Zwischenlagerung in der Gemeinschaftsverpflegung, dem Hotel-, Restaurant- oder Gastronomiebereich, das nutzenorientierte Regalwagenprogramm deckt vielfältigste Anforderungsprofile ab. So können Wagen für GN- und EN-Tablets, GN-Behälter, Roste, Backbleche, Kältespeicherplatten oder Einschubkörbe küchenlogistische Abläufe effizienter gestalten.

Le chariot à glissières de HUPFER® – un produit essentiel dans la cuisine industrielle. Qu'il s'agisse de la préparation ou du stockage provisoire dans l'alimentation collective ou bien dans des cuisines d'hôtel, de restaurant ou de la gastronomie, le programme de chariots à glissières répond aux profils d'exigences les plus multiples. Ainsi des chariots pour plateaux GN et EN, bacs GN, plaques ou grilles rendent le déroulement logistique plus efficace.

Art-Nr./No d'article	Aussenmasse/Dimensions	Kapazität/Capacité	Preis/prix
0112465	45,9 x 62,4 cm x H 85,4 cm	7 x GN 1/1	939.75
0112445	66,4 x 74,4 cm x H 85,4 cm	7 x GN 2/1 / 14 x GN 1/1	988.00
0112505	81,5 x 62,4 cm x H 85,4 cm	14 x GN 1/1	1644.75

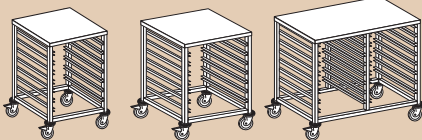

0112465

0112445

0112505

**FERTIG MONTIERT
PRÊT ASSEMBLÉ**

HUPFER

**Regalwagen
Chariot à glissières**

Vollständig aus Inox
En inox



Der Regalwagen von HUPFER® – ein zentrales Produkt in der gewerblichen Küche. Ganz gleich, ob Bereitstellung oder Zwischenlagerung in der Gemeinschaftsverpflegung, dem Hotel-, Restaurant- oder Gastronomiebereich, das nutzenorientierte Regalwagenprogramm deckt vielfältigste Anforderungsprofile ab. So können Wagen für GN- und EN-Tablets, GN-Behälter, Roste, Backbleche, Kältespeicherplatten oder Einschubkörbe küchenlogistische Abläufe effizienter gestalten.

Le chariot à glissières de HUPFER® – un produit essentiel dans la cuisine industrielle. Qu'il s'agisse de la préparation ou du stockage provisoire dans l'alimentation collective ou bien dans des cuisines d'hôtel, de restaurant ou de la gastronomie, le programme de chariots à glissières répond aux profils d'exigences les plus multiples. Ainsi des chariots pour plateaux GN et EN, bacs GN, plaques ou grilles rendent le déroulement logistique plus efficace.

Art-Nr./No d'article	Aussenmasse/Dimensions	Kapazität/Capacité	Preis/prix
0112775	45,9 x 62,4 cm x H 166,7 cm	18 x GN 1/1-65	822.10
0119002	45,9 x 62,4 cm x H 181,7 cm	20 x GN 1/1-65	1324.25
0112535	66,4 x 74,4 cm x H 166,7 cm	36 x GN 1/1-65	939.05
0112575	81,8 x 62,4 cm x H 166,7 cm	2 x 18 x GN 1/1-65	1881.05



0112775

0119002

0112535

0112575

**BEST
SELLER**



HUPFER

**Regalwagen geschlossen
Chariot à glissières**

Der einzige serienmässig komplett geschlossene Regalwagen bietet durch seinen Schienenabstand von 75 mm eine vergleichsweise bis zu 50 % grössere Kapazität (Bestückung mit GN-Behältern in 150 mm Tiefe ohne Deckel). Wagen mit einem Fach in stabiler, selbsttragender und hygienischer Konstruktion aus hochwertigem Edelstahl-Vierkanthrohr mit allseitiger Verkleidung und Flügeltür. Fest eingeschweisste U-Auflageschienen mit beidseitigen Durchschub- und Kippsicherungen. 4 Abweiserrollen aus Polyethylen. Wagen fahrbar auf 4 Lenkrollen, davon 2 mit Totalfeststellern, ø 125 mm, mit Zapfenbefestigung. *Le seul chariot à rayonnages entièrement fermé de série fournit une capacité de jusqu'à 50% supérieure grâce à son écart entre les rails de 75 mm (équipement avec récipients GN en profondeur 150 mm sans couvercle). Chariot avec un compartiment de construction stable, autoporteuse et hygiénique en tube carré en acier inoxydable de qualité avec habillage de tous les côtés et porte double. Rails de support en U fermement soudés avec sécurisations contre le passage et le basculement des deux côtés. 4 roulettes défectrices en polyéthylène. Chariot roulant sur 4 roulettes directrices, dont 2 avec blocage total, ø 125 mm, avec fixation par tenon.*

Art.-Nr./No d'article	Aussenmasse/Dimensions	Kapazität/Capacité	Preis/prix
0163351	73,9 x 65,9 cm x H 166,5 cm	36 x GN 1/1	2585.00



HUPFER

**Schutzhaube für Regalwagen
Housse de protection pour chariot à glissières**

Polyethylen, mit Sichtfenster, mit frontseitigem Reissverschluss
Polyéthylène, avec hublot, avec fermeture éclair à l'avant

Art.-Nr./No d'article	Aussenmasse/Dimensions	Format	passend/avec	Preis/prix
0123742	42,5 x 58 cm x H 150 cm	GN 1/1	0117775+0119002	388.00
0123722	63 x 69 cm x H 150 cm	GN 2/1	0112535	398.85

**Schutzhülle auf Rolle
Housse de protection en rouleau**

Polypropylen, dicke 15 Mikrometer, 100% recyclebar, Rolle mit Pappkern, Karton mit 200 vorgestanzten Schutzhüllen, ideale Anwendung mit einem Wanddispenser

Polypropylène, épaisseur 15 microns, 100% recyclable, présentation en rouleau sur mandrin carton, carton de 200 housses prédécoupées, utilisation pratique avec un dévidoir mural

Art.-Nr./No d'article	Format	Umfang/Périmètre	Länge/hauteur	passend/avec	Preis/prix
8006.50900	GN 1/1	189 cm	180 cm	0112775	164.45
8006.50910	GN 2/1	219 cm	180 cm	0112535	199.70

**Wanddispenser für Schutzhüllen auf Rolle
Dévidoir mural housse de protection en rouleau**

Art.-Nr./No d'article	Aussenmasse/Dimensions	Preis/prix
8006.50920	42,5 x 87 x H 30 cm	398.85



ROLLMATERIAL / MATÉRIEL ROULANT



0119332



0121593



0129163

Korbroller
Chariot socle rouleur
HUPFER

Vollständig aus Inox, für Körbe 50 x 50 cm
 En inox, pour corbeille 50 x 50 cm

Geschirrkörbe einfach, schnell und günstig transportieren, dafür sind die Korbroller von HUPFER® die richtige Wahl. Gerade wegen der einfachen und robusten Konstruktion ist es mit diesem Produkt möglich, eine grosse Anzahl von Geschirrkörben zu transportieren.

Afin de transporter les casiers de vaisselle facilement et rapidement le chariot socle rouleur est le choix juste. À cause de la construction simple et robuste il est possible de transporter un grand nombre de casiers de vaisselle.

Ausführung mit Schiebegriffen
Exécution avec poignée

Art-Nr./No d'article	Aussenmasse/dimensions	Kapazität/capacité	Preis/prix
0119332	71 x 58 cm x H 102,7 cm	12 Körbe H 11,5 cm oder 20 Körbe H 7,5 cm	822.10

Ausführung ohne Schiebegriffe
Exécution sans poignée

0121593	52,5 x 52,5 cm x H 18,7 cm	12 Körbe H 11,5 cm oder 20 Körbe H 7,5 cm	317.40
---------	----------------------------	--	---------------

Schiebegriff zur Selbstmontage
Exécution avec poignée

0129163			233.85
---------	--	--	---------------

HUPFER
Korbroller mit Wanne und Griff
Chariot socle rouleur avec bac et poignée

Vollständig aus Inox, für Körbe 50 x 50 cm
 En inox, pour corbeille 50 x 50 cm

Ein paar Geschirrkörbe bewegen. Ganz einfach, ohne viel Aufwand. Aber leicht muss es gehen und natürlich wie immer schnell. Unser Helfer ohne grosses Aufsehen - der Korbroller. Robust, schnell und effizient sorgt er für Bewegung bei Körben. Edelstahl, 4 Lenkrollen, Ø 125 mm, in korrosiongeschützten Gehäusen, davon 2 mit Totalfeststellern.

Déplacer les paniers à vaisselle tout simplement avec un minimum d'effort. Le chariot socle rouleur assure une conduite très maniable, facile et silencieuse. Solide, performant, efficace pour un déplacement des paniers en toute sécurité. En inox, bac résistant à la corrosion, 4 roues pivotantes Ø 125 mm dont 2 avec frein.

Art-Nr./No d'article	Aussenmasse/dimensions	Preis/prix
0119350	61 x 52 cm x H 20,5/79,5 cm	586.80

«Magic-Saver»
Tellerstapler
Porte-assiettes

Metalldraht verchromt, mit rutschfestem Doppelstapelring für alle Tellergrößen von Ø 16-32 cm, für 9 Teller, platzsparend, es können 5 Magic-Saver ineinander gestapelt werden.

Cable en métal chromé, avec boucle double-empilant antidérapante pour tous les grandeurs d'assiettes de Ø 16 - 32 cm, pour 9 assiettes, économisant d'espace, 5 Magic-servers peuvent être empilés dans l'un et l'autre.

Art-Nr./No d'article	Grösse/grandeur	Preis/prix
8335.00500	35,5 x 32 x H 83 cm	132.90

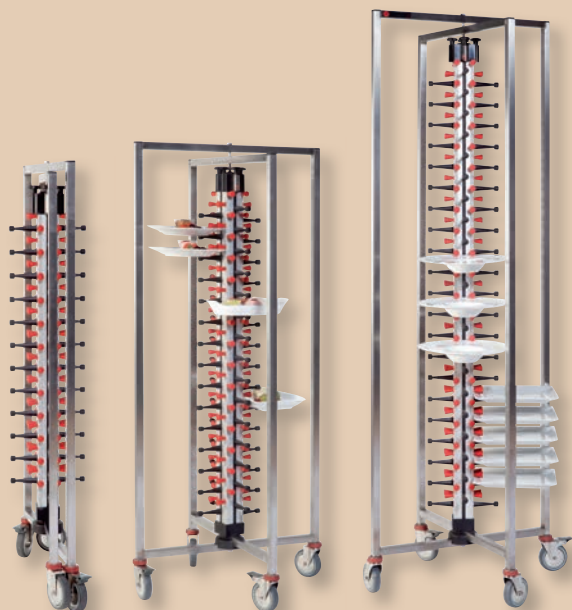

PLATE MATE
Tellerstapler fahrbar
Chariot à assiettes
 zusammenklappbar
 pliable

Art-Nr./No d'article	Grösse/grandeur	Höhe/hauteur	Teller/assiettes	Preis/prix
8007.12008	65 x 65 cm	127 cm	48	1763.30
8007.12009	65 x 65 cm	149 cm	60	1881.05
8007.12000	65 x 65 cm	190 cm	84	2351.50



PLATE MATE
Schutzhaube für fahrbare Tellerstapler
Housse de protection pour chariot à assiettes

Art-Nr./No d'article	Passend zu/pour	Grösse/grandeur	Höhe/hauteur	Preis/prix
8007.12010	8007.12008	69 x 70 cm	115 cm	469.20
8007.12011	8007.12009	69 x 70 cm	131 cm	505.60
8007.12001	8007.12000	69 x 70 cm	174 cm	611.50

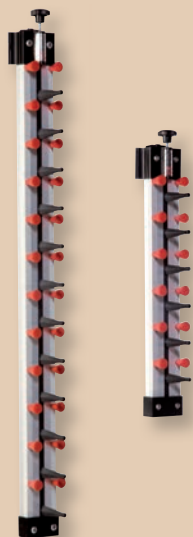

PLATE MATE
Tellerstapler Wandmodell
Porte- assiettes, version murale

Art-Nr./No d'article	Teller/assiettes	Höhe/hauteur	Preis/prix
8007.12030	6	57 cm	305.60
8007.12031	9	77 cm	388.60
8007.12032	12	99 cm	458.60
8007.12033	18	141 cm	564.45

ROLLMATERIAL / MATÉRIEL ROULANT

PLATE MATE
Tellerstapler als Tischmodell
Porte-assiettes de table

Lieferung inkl. Traggriff, optionale Lenkrollen müssen separat bestellt werden!
 Livraison incl. poignée, set de roulettes à commander séparément!

Art-Nr./No d'article	Grösse/grandeur	Höhe/hauteur	Teller/assiettes	Preis/prix
8007.12002	36 x 36 cm	49 cm	12	458.60
8007.12003	36 x 36 cm	73 cm	24	822.10
8007.12004	36 x 36 cm	93 cm	36	998.40
8007.12005	36 x 36 cm	114 cm	48	1324.25

Zubehör/Accessoires

8007.12007 Lenkrollenset/Set de roulettes 258.55

Ersatzteile/Pièces de rechange

8007.12006 Ersatz-Traggriff/poignée de rechange 35.05

HUPFER
Tellertransportwagen für 1-seitige Beschickung
Chariots de transport d'assiettes, simple face

Niedriger Ausführung, einseitig beschickbar, für Lagerung und Transport von stapelbaren Geschirnteilen wie Teller und Cloches. Wagen in stabiler, selbsttragender und hygienischer Konstruktion aus hochwertigem Edelstahl.
 Chariot de transport d'assiettes en exécution basse, pouvant être rempli d'un côté, pour le stockage et le transport de pièces de vaisselle empilables, comme p. ex. les assiettes et les cloches. Chariot à structure solide, monocoque et hygiénique en acier inoxydable haut de gamme.



Art-Nr./No d'article	Grösse/grandeur	Kapazität/capacité	Preis/prix
0163479	100 x 49,5 cm x H 74,3 cm	150	764.45

Zubehör/Accessoires

0163485 Trenngitter ohne Frontsicherung 56.40

Grille de séparation sans sécurisation frontale

0163486 Trenngitter mit Frontsicherung 90.55

Grille de séparation avec sécurisation frontale

0191246081 Schutzhaube PE 152.70

Capot de protection
 94 x 45,5 x 58,5 cm

HUPFER
Tellertransportwagen für 2-seitige Beschickung
Chariots de transport d'assiettes, double face

Niedriger Ausführung, zweiseitig beschickbar, für Lagerung und Transport von stapelbaren Geschirnteilen wie Teller und Cloches. Wagen in stabiler, selbsttragender und hygienischer Konstruktion aus hochwertigem Edelstahl.
 Chariot de transport d'assiettes en exécution basse, pouvant être rempli deux côtés, pour le stockage et le transport de pièces de vaisselle empilables, comme p. ex. les assiettes et les cloches. Chariot à structure solide, monocoque et hygiénique en acier inoxydable haut de gamme.



Art-Nr./No d'article	Grösse/grandeur	Kapazität/capacité	Preis/prix
0163481	100 x 76,5 cm x H 74,3 cm	300	1458.55

Zubehör/Accessoires

0163485 Trenngitter ohne Frontsicherung 56.40

Grille de séparation sans sécurisation frontale

0163486 Trenngitter mit Frontsicherung 90.55

Grille de séparation avec sécurisation frontale

0191223444 Schutzhaube PE 141.10

Capot de protection
 94 x 73,5 x 58,5 cm

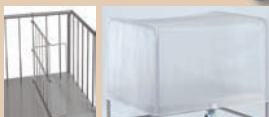

ROLLMATERIAL ELEKTRISCH / MATÉRIEL ROULANT ÉLECTRIQUE



Weitere Modelle
auf Anfrage.
Autres modèles
sur demande.



T13



HUPFER

Tellerstapler, 1 Schacht, verstellbar, statisch beheizt
Chariot à assiettes, 1 conduit, réglable, chauffant statiquement

Aus Inox. Viele Details wie z.B. die einfache Einstellung auf alle gängigen Tellergrößen, die unkomplizierte Bedienung, die hohen Tellerstapel und die stufenlose Temperaturregelung verdeutlichen den hohen Anwendernutzen.

En inox. Beaucoup de détails, comme p.ex. le réglage simple des guides en fonction du diamètre des assiettes, l'utilisation facile, les piles d'assiettes hautes et le réglage précis de température clarifient la grande utilité.

Art-Nr./No d'article	Grösse/grandeur	Teller/assiettes	Preis/prix
0162808	46 x 61 x H 90 cm	Ø 19-26, max. 83 pcs	2493.85
0162809	53 x 71 x H 90 cm	Ø 27-33, max. 61 pcs	2586.85



T13



HUPFER

Tellerstapler, 2 Schacht, verstellbar, statisch beheizt
Chariot à assiettes, 2 conduit, réglable, chauffant statiquement

Aus Inox. Viele Details wie z.B. die einfache Einstellung auf alle gängigen Tellergrößen, die unkomplizierte Bedienung, die hohen Tellerstapel und die stufenlose Temperaturregelung verdeutlichen den hohen Anwendernutzen.

En inox. Beaucoup de détails, comme p.ex. le réglage simple des guides en fonction du diamètre des assiettes, l'utilisation facile, les piles d'assiettes hautes et le réglage précis de température clarifient la grande utilité.

Art-Nr./No d'article	Grösse/grandeur	Teller/assiettes	Preis/prix
0162810	46 x 93,5 x H 90 cm	Ø 19-26, max. 166 pcs	2822.10
0162811	53 x 105,5 x H 90 cm	Ø 27-33, max. 122 pcs	3057.40

ROLLMATERIAL ELEKTRISCH / MATÉRIEL ROULANT ÉLECTRIQUE



T13



0162994

Universal-Geschirrstapler, umluftbeheizt
Chariot universel pour vaisselle, chauffage à chaleur ventilée
HUPFER

Aus Inox. Zur Bereitstellung von Geschirrtteilen in Körben – und das in der gewünschten Ausgangstemperatur, ganz gleich ob kalt oder warm. Geschirr: für runde und rechteckige Teile bis 280 mm Ø bzw. Kantenlänge, auch für kleine Teile geeignet Anzahl Geschirrstapel: bis zu 21 je nach Geschirrgröße Stapelhöhe ohne Haube in mm: 565 mm Stapelhöhe mit Haube in mm: 675 mm Maximale Geschirrtemperatur: 85° C Thermostateinstellung: 20 - 110° C Fahrgestell: 4 Lenkrollen, davon 2 mit Totalfeststeller, Ø 125 mm Tragkraft: 100 kg Nettogewicht: 56 kg

En inox. Préparation de vaisselle en panier – ceci dans la température souhaitée, que ce soit froid ou chaud. Vaisselle: ronde ou rectangulaire jusqu'à 280 mm avec les bords, aussi pour les petites pièces, nombre de pièces: jusqu'à 21 pièces selon la grandeur, hauteur de la pile sans coiffe: 565 mm, avec coiffe 675 mm. Température maximale 85° C, réglage du thermostat 20 - 10 °, châssis: 4 roues, 2 avec systèmes de blocage total. 125 mm puissance de portée 100 kg, poids net 56 kg.

Art-Nr./No d'article	Grösse/grandeur	Anschlusswert/puissance	Preis/prix
0162994	51 x 75 cm x H 90 cm	230 V / 1,0 kW	3998.55

Zubehör/Accessoires

014122075	Abdeckhaube/Couverde		270.35
------------------	----------------------	--	---------------

HUPFER
Fahrbare Stapelgeräte
Chariots distributeurs mobiles

Aus Inox. Verschiedene Anforderungsprofile in der Geimanschaftsverpflegung erfüllt HUPFER® mit dem Tablettstaplerprogramm. Bereitstellung von Tablett im Kundenbereich von Selbstbedienungstheken, an Speisenverteilbändern oder auch die automatische Abstapelung von Tablett beim Schmutzgeschirr-Rücklaufband sind die verschiedenen Einsatzgebiete.

En inox. HUPFER® répond par la gamme de chariots pour plateaux aux divers profils d'exigences dans l'alimentation collective. Les différents terrains d'action sont la préparation de plateaux à la zone de clients de buffets self-services et aux convoyeurs de conditionnement de repas, ou bien l'empilage automatique de plateaux aux convoyeurs de retour de vaisselle sale.



0162774

0162775

Art-Nr./No d'article	Artikel/article	Plattform/Plate-forme	Preis/prix
0162774	51 x 80 cm x H 90 cm	480 x 380 mm	2351.50
0162775	51 x 80 cm x H 90 cm	540 x 380 mm	1998.55

HUPFER
Fahrbare Stapelgeräte
Chariots distributeurs mobiles
Modelle mit verstellbarer Stapelführung
Modèles avec guide d'empilage réglable

Aus Inox. Verschiedene Anforderungsprofile in der Geimanschaftsverpflegung erfüllt HUPFER® mit dem Tablettstaplerprogramm. Bereitstellung von Tablett im Kundenbereich von Selbstbedienungstheken, an Speisenverteilbändern oder auch die automatische Abstapelung von Tablett beim Schmutzgeschirr-Rücklaufband sind die verschiedenen Einsatzgebiete.

En inox. HUPFER® répond par la gamme de chariots pour plateaux aux divers profils d'exigences dans l'alimentation collective. Les différents terrains d'action sont la préparation de plateaux à la zone de clients de buffets self-services et aux convoyeurs de conditionnement de repas, ou bien l'empilage automatique de plateaux aux convoyeurs de retour de vaisselle sale.

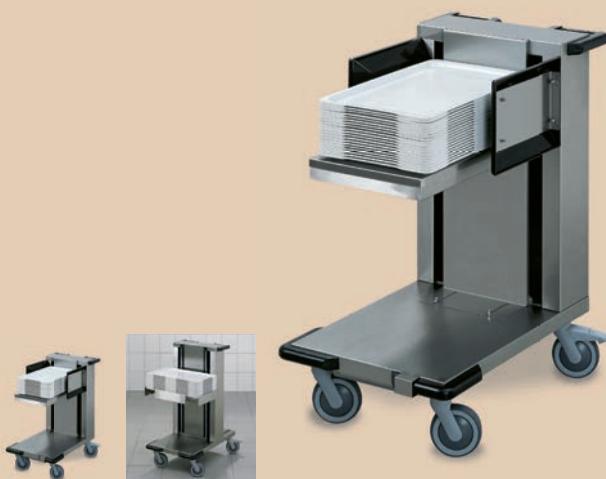

0162777

0161740

Art-Nr./No d'article	Artikel/article	Plattform/Plate-forme	Preis/prix
0162777	51 x 80 cm x H 90 cm	450-545/325-380 mm	2351.50
0161740	51 x 80 cm x H 90 cm	325-555/320-566 mm	3057.40



Mahlzeit mit Tafelkultur

Ob Warmtransport oder Regenerierung – Caldo Casa schafft Kundenzufriedenheit und Spitex-Gewinn bei Senioren, im Büro, auf dem Bau oder im Schichtbetrieb. Vorbei sind die Zeiten der unförmigen Boxen oder Plastiktaschen – formschönes Porzellan erfreut Augen und Gaumen. Caldo Casa ermöglicht gepflegtes Table Top im Mahlzeitendienst. Die Auswahl an Porzellanteilen erlaubt je nach Verwendungszweck den gepflegten Service verschiedenster Menüs. Die Deckel sind einfach abnehmbar, auch für Personen mit eingeschränkter Beweglichkeit. Alle Porzellanteile können leicht der Kassette entnommen werden.

La culture à table

Que ce soit le transport à chaud ou régénéré – Caldo Casa crée satisfaction chez les clients, et avantage Spitex chez les personnes âgées, au bureau, sur le chantier ou les professions de roulement d'équipes. Passé le temps des caisses déformées ou des sacs en plastique – une porcelaine attrayante réjouit le palais et les yeux. Caldo Casa permet une table top en beauté au service des repas. Le choix des articles de porcelaine apporte, selon le but de l'utilisation, un service soigné aux divers menus. Les couvercles s'enlèvent facilement, même pour les personnes à mobilité restreinte. Toutes les pièces de porcelaine peuvent aisément être enlevées du caisson.



CALDO CASA



Die Kassette misst 435 x 370 x 100 mm und kann in einem mittleren Haushaltskühlschrank gelagert werden. Die Heizstation mit Induktion wird mittels Stecker an einer 230 V Steckdose angeschlossen und benötigt pro Mahlzeit maximal 150 Watt. Caldo Casa ist sehr gut stapelbar. Das Induktionstablett ist mit einem feuchten Tuch zu reinigen, alle anderen Teile sind spülmaschinentauglich.

Auf Wunsch liefern wir Ihnen gerne ein Probeset.

Le caisson mesure 435 x 370 x 100 mm et tient dans un frigidaire ménager moyen. La station de chauffage avec induction peut être branchée sur 230 V et nécessite par repas maximum 150 Watt. Caldo Casa extrêmement bien empilable. Le plateau à induction se nettoie avec un chiffon humide, toutes les autres pièces vont à la machine à laver la vaisselle.

Nous vous envoyons sur demande un élément à l'essai.



Set Caldo Casa Set Caldo Casa

Ein Set beinhaltet: 1 Oberteil, 1 Unterteil, 1 Einsteckplättchen,
1 Satz Porzellan inkl. Deckel

Comprenant: 1 partie supérieure, 1 partie inférieure, 1 station à induction,
1 set de porcelaine avec couvercle



Caldo Casa Oberteil Partie supérieure Caldo Casa

hellgrau
gris clair

Art-Nr./No d'article Aussenmasse/dimensions
625041304 430 x 372 x 70 mm

Preis/prix
93.85



Caldo Casa Unterteil Partie inférieure Caldo Casa

hellgrau
gris clair

Art-Nr./No d'article Aussenmasse/dimensions
625040304 430 x 372 x 40 mm

Preis/prix
82.10



T13



Induktionsstation Station à induction

grau
Elektrischer Anschluss: 230V / 150 W
gris
Tension nominale: 230 V / 150 W

Art-Nr./No d'article Aussenmasse/dimensions
625042305 405 x 345 x 40 mm

Anschluss/puissance
230V / 150 W

Preis/prix
1161.90





Deckel zu Teller
Couvercle pour assiette

Art-Nr./No d'article	Grösse/grandeur	Preis/prix
625043304	250 x 225 mm	9.55

Teller ohne Beschichtung
Assiette sans revêtement à induction

Art-Nr./No d'article	Grösse/grandeur	Preis/prix
29550025051	250 x 225 mm ①	18.35
29550052051	250 x 225 mm ②	18.35



Teller mit Induktions-Beschichtung
Assiette avec revêtement à induction

Art-Nr./No d'article	Grösse/grandeur	Preis/prix
29550026051	250 x 225 mm ①	38.60
29550053051	250 x 225 mm ②	38.60



Deckel zu Eintopfschale
Couvercle pour cocotte

Art-Nr./No d'article	Grösse/grandeur	Preis/prix
625045304	Ø 17 cm	8.90

Eintopfschale ohne Beschichtung
Cocotte sans revêtement à induction

Art-Nr./No d'article	Grösse/grandeur	Preis/prix
29580017051	78 cl / Ø 16,3 cm	22.10



Eintopfschale mit Induktions-Beschichtung
Cocotte avec revêtement à induction

Art-Nr./No d'article	Grösse/grandeur	Preis/prix
29580018051	78 cl / Ø 16,3 cm	55.95



Deckel mit Silikondichtung zu Suppenschale
Couvercle avec joint silicone pour bol à potage

Art-Nr./No d'article	Grösse/grandeur	Preis/prix
625056304	Ø 12,5 cm	23.25

Suppenschale ohne Beschichtung
Bol à potage sans revêtement à induction

Art-Nr./No d'article	Grösse/grandeur	Preis/prix
29556045051	48 cl / Ø 12,5 cm	16.75



Suppenschale mit Induktions-Beschichtung
Bol à potage avec revêtement à induction

Art-Nr./No d'article	Grösse/grandeur	Preis/prix
29556046051	48 cl / Ø 12,5 cm	41.95

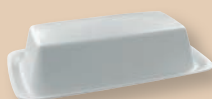

Deckel zu Schale rechteckig
Couvercle pour plat rectangulaire

Art-Nr./No d'article	Grösse/grandeur	Preis/prix
625050304	17 x 10 cm	8.90

Schale rechteckig ohne Beschichtung
Plat rectangulaire sans revêtement à induction

Art-Nr./No d'article	Grösse/grandeur	Preis/prix
29588017051	30 cl / 17 x 10 cm	12.75



SPEISENTRANSPORT / TRANSPORT D'ALIMENTS



BLU'BOX 26 standard

Passive Speisetransportbox
Heiss- oder Kalthalten von Speisen in GN-Behältern
box de transport passif
maintenir les aliments chauds ou froids dans les bacs GN

GN-Behälter nicht im Lieferumfang enthalten.
Contenu de livraison sans bac GN.

Art-Nr./No d'article	Grösse/grandeur	Fassungsvermögen/capacité	Preis/prix
4000330	63 x 37 cm x H 30,8 cm / 6,2 kg	GN 1/1	446.80



BLU'BOX 26 standard cool

Passive Transportbox
Kühlen der Speisen in GN-Behältern mit Hilfe eines Kühl-Akkus
hoher Deckel für Einlage und Befestigung des Kühl-Akkus
box de transport passif
rafraîchir des aliments dans les bacs GN avec un accu cool
couvercle haut pour adapter et fixer l'accu cool

Im Lieferumfang enthalten: Hoher Deckel mit Kühl-Akku.
GN-Behälter nicht im Lieferumfang enthalten.
Inclus dans la livraison: Couvercle haut avec accu cool
Contenu de livraison sans bac GN.

Art-Nr./No d'article	Grösse/grandeur	Fassungsvermögen/capacité	Preis/prix
4000434	63 x 37 cm x H 30,8 cm / 10,1 kg	GN 1/1	611.50



BLU'BOX 26 plus

Transport von heissen und kalten Speisen, Diät- und Schonkost
Transport des aliments chauds, froids et diététiques

Im Lieferumfang enthalten: Verschlussstopfen
Inclus dans la livraison: bouchon de fermeture

Art-Nr./No d'article	Grösse/grandeur	Fassungsvermögen/capacité	Preis/prix
4000410	63 x 37 cm x H 30,8 cm / 7,5 kg	GN 1/1	552.70



T13



BLU'BOX 26 plus hot

Aktive Speisentransportbox
 Erhitzen von Speisen in GN-Behältern
 Zwei Betriebsarten: Trockenbetrieb oder Bain-Marie-Prinzip im Wasserbad (empfohlen)
 230 V / 350 W
box de transport actif
chauffage des aliments dans les bacs GN
deux modes d'utilisation: sec ou au bain-marie (recommandé)
 230 V / 350 W

Im Lieferumfang enthalten: Verschlussstopfen, Heizschwert, Anschlusskabel
Inclus dans la livraison: bouchon de fermeture, dispositif de chauffe, câble de raccordement

Art-Nr./No d'article	Grösse/grandeur	Fassungsvermögen/capacité	Preis/prix
4000339	63 x 37 cm x H 30,8 cm / 7,5 kg	GN 1/1	998.40



BLU'BOX 52 GN

Verteilung von heissen und kalten Speisen mit GN-Behältern
 Platz für max. 2 GN-Behälter (1/1, 200 mm)
 Belastbar bis zu 100°C
distribution des aliments chauds et froids avec bacs GN
espace pour max. 2 bacs GN (1/1, 200 mm)
résistant jusqu'à 100°C

Art-Nr./No d'article	Grösse/grandeur	Fassungsvermögen/capacité	Preis/prix
4000445	63,6 x 44,8 cm x H 55 cm / 11,8 kg	GN 1/1	740.00



BLU'BOX 52 GN/EN

Erste Speisentransportbox für GN- und EN-Behälter
 Verstellbare Stapelroste aus CNS
 Transport von Behältern mit bis zu 250°C möglich
 Einsatz von Kühl-Akkus möglich
premier box de transport pour bacs GN et EN
grilles à empiler réglables en CNS
transport des bacs possible jusqu'à 250°C
élément accu de refroidissement possible

Im Lieferumfang enthalten: 2 x CNS Stapelroste
Inclus dans la livraison: 2 x grilles pour empiler CNS

Art-Nr./No d'article	Grösse/grandeur	Fassungsvermögen/capacité	Preis/prix
4000348	63,6 x 49,8 cm x H 56 cm / 16,4 kg	GN/EN 1/1	788.00

SPEISENTRANSPORT / TRANSPORT D'ALIMENTS



T13

**BLU'BOX 52 GN hot²****Aktive Transportbox mit regelbarer Umluftheizung**
Box de transport actif avec chauffage à air pulsé réglable

Erhitzen von Speisen in GN-Behältern, in Tür integrierte Umluftheizung sorgt für erforderliche Heizleistung und gleichmässige Luftzirkulation, einfache Bedienung über Temperaturregler (Zwei-Tasten-System), stufenlos regelbar von +50 bis +85°C, im Lieferumfang enthalten: Tür mit integrierter Umluftheizung, Anschlusskabel

Chauffage des aliments dans les bacs GN, le chauffage à air pulsé, intégré dans la porte, fournit la puissance calorifique et une circulation d'air régulière, utilisation facile à l'aide du régulateur de température (Système à deux boutons), réglage progressif de +50 à +85 °C, inclus dans la livraison: porte avec chauffage à air pulsé intégré, câble de raccordement

230 V / 500 W

Art-Nr./No d'article	Grösse/grandeur	Fassungsvermögen/capacité	Preis/prix
4000663	63,9 x 44,6 cm x H 56 cm / 14,5 kg	GN 1/1	1763.05



T13

**BLU'BOX 52 GN/EN hot²****Aktive Transportbox mit regelbarer Umluftheizung**
Box de transport actif avec chauffage à air pulsé réglable

Erhitzen von Speisen in GN- oder EN-Behältern, in Tür integrierte Umluftheizung sorgt für erforderliche Heizleistung und gleichmässige Luftzirkulation, einfache Bedienung über Temperaturregler (Zwei-Tasten-System), stufenlos regelbar von +50 bis +85°C, im Lieferumfang enthalten: 2 x Stapelroste, Tür mit integrierter Umluftheizung, Anschlusskabel

Chauffage des aliments dans les bacs GN ou EN, le chauffage à air pulsé, intégré dans la porte, fournit la puissance calorifique et une circulation d'air régulière, utilisation facile à l'aide du régulateur de température (Système à deux boutons), réglage progressif de +50 à +85 °C, inclus dans la livraison: 2 x grilles pour empiler, porte avec chauffage à air pulsé intégré, câble de raccordement

230 V / 500 W

Art-Nr./No d'article	Grösse/grandeur	Fassungsvermögen/capacité	Preis/prix
4000664	63,9 x 50 cm x H 56 cm / 18,2 kg	GN/EN 1/1	1881.05



T13

**BLU'BOX 52 GN hot² lite****Aktive Transportbox mit selbstregelnder Umluftheizung**
Box de transport actif avec chauffage à air pulsé à autorégulation

Erhitzen von Speisen in GN-Behältern, in Tür integrierte Umluftheizung sorgt für erforderliche Heizleistung und gleichmässige Luftzirkulation, einfache Bedienung, selbstregelnde Heiztechnologie, aufheizen des Behälters auf ca. + 80 °C, im Lieferumfang enthalten: Tür mit integrierter Umluftheizung, Anschlusskabel

Chauffage des aliments dans les bacs GN, le chauffage à air pulsé, intégré dans la porte, fournit la puissance calorifique et une circulation d'air régulière, utilisation facile, technologie de chauffage à autorégulation, chauffage des contenants jusqu'à env. +80°C, inclus dans la livraison: porte avec chauffage à air pulsé intégré, câble de raccordement

230 V / 500 W

Art-Nr./No d'article	Grösse/grandeur	Fassungsvermögen/capacité	Preis/prix
4000679	63,9 x 44,6 cm x H 56 cm / 14,5 kg	GN 1/1	1410.15



T13

**BLU'BOX 52 GN/EN hot² lite****Aktive Transportbox mit selbstregelnder Umluftheizung**
Box de transport actif avec chauffage à air pulsé à autorégulation

Erhitzen von Speisen in GN- oder EN-Behältern, in Tür integrierte Umluftheizung sorgt für erforderliche Heizleistung und gleichmässige Luftzirkulation, einfache Bedienung, selbstregelnde Heiztechnologie, aufheizen des Behälters auf ca. + 80 °C, im Lieferumfang enthalten: 2 x Stapelroste, Tür mit integrierter Umluftheizung, Anschlusskabel

Chauffage des aliments dans les bacs GN ou EN, le chauffage à air pulsé, intégré dans la porte, fournit la puissance calorifique et une circulation d'air régulière, utilisation facile, technologie de chauffage à autorégulation, chauffage des contenants jusqu'à env. +80°C, inclus dans la livraison: 2 x grilles pour empiler, porte avec chauffage à air pulsé intégré, câble de raccordement

230 V / 500 W

Art-Nr./No d'article	Grösse/grandeur	Fassungsvermögen/capacité	Preis/prix
4000680	63,6 x 49,8 cm x H 56 cm / 18,2 kg	GN/EN 1/1	1458.55

**BEST
SELLER**



**BEST
SELLER**

BLU'TRAY

Tablett für den Transport von Speisen in heissem und kaltem Zustand
Tableau pour transport de repas chaud ou réfrigéré

In Lieferung enthalten: 4-teilige Porzellangarnitur (1 abgeteilter Teller, 1 Suppenschale, 2 Kaltschalen), 4 Deckel aus PP mit Dichtungen, Wärmekernteller Inox
Compris dans la livraison: Garnitur porcelaine 4 pces (1 assiette séparée, 1 bol à soupe, 2 coupes), 4 couvercles en PP avec joints, Assiette calorifuge Inox

Art-Nr./No d'article Grösse/grandeur
4000556 37 x 53 cm x H 11 cm / 3,2 kg

Preis/prix
623.25



BLU'BOX Hoher Deckel BLU'BOX Couvercle haut

Deckel zur Verwendung des Kühlelements.
Couvercle pour l'utilisation du pack réfrigérant "cool-accu".

Art-Nr./No d'article
664201677

Preis/prix
188.10



BLU'BOX cool-accu

Für blu'box 26 und 52 Serie, GN 1/1, Gewicht: 2,4 kg: cool-accu 1,6 kg
Pour la série blu'box 26 et 52, GN 1/1, Poids :2.4 kg : cool accu 1,6 kg

Art-Nr./No d'article Grösse/grandeur
4000388 52,5 x 32 x H 4 cm

Preis/prix
132.90



T13



Heischwert Plaque chauffante

Für die blu'box 26 Serie, max. Temperatur: ca 125 °C
Pour la série blu'box 26, température max.: env. 125°C

Art-Nr./No d'article
8001751

Anschlusswert/puissance
230 V / 0,35 kW

Preis/prix
529.15

SPEISENTRANSPORT / TRANSPORT D'ALIMENTS



BLU'BOX
Anschlusskabel
Câble de raccordement
 VDE geprüft, schwarz
 Noir

Art-Nr./No d'article Länge/longueur
8002152 2 m

Preis/prix
30.55



T13

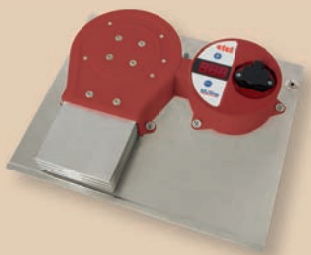

BLU'BOX 52 hot²
Regelbare Umluftheizung
Chauffage à air pulsé réglable

Zum Nachrüsten älterer Modelle geeignet.
 Passt zu Ersatztüre 664202521 + 664202558
 Approprié pour un équipement ultérieur d'anciens modèles.
 Pour porte de rechange 664202521 + 664202558

Art-Nr./No d'article
8003130

Anschlusswert/puissance
 230 V / 0,5 kW

Preis/prix
893.85



T13



BLU'BOX 52 hot² lite
Selbstregelnde Umluftheizung
Chauffage à air pulsé à autorégulation

Zum Nachrüsten älterer Modelle geeignet.
 Passt zu Ersatztüre 664202521 + 664202558
 Approprié pour un équipement ultérieur d'anciens modèles.
 Pour porte de rechange 664202521 + 664202558

Art-Nr./No d'article
8003185

Anschlusswert/puissance
 230 V / 0,5 kW

Preis/prix
586.80



BLU'BOX
Ersatztüre BLU'BOX 52 GN
Porte de rechange BLU'BOX 52 GN

Zum Nachrüsten älterer Modelle geeignet. Lieferung ohne Heizung.
 Approprié pour un équipement ultérieur d'anciens modèles. Sans chauffage.

Art-Nr./No d'article Grösse/grandeur
664202521

Preis/prix
223.40

BLU'BOX
Ersatztüre BLU'BOX 52 GN/EN
Porte de rechange BLU'BOX 52 GN/EN

Zum Nachrüsten älterer Modelle geeignet. Lieferung ohne Heizung.
 Approprié pour un équipement ultérieur d'anciens modèles. Sans chauffage.

Art-Nr./No d'article Grösse/grandeur
664202558

Preis/prix
223.40



Stapelarretierung für BLU'BOX 52 Arrestation d'empilage pour BLU'BOX 52

Für die blu'box 52 Serie zur leicht lösbaren, festen Verbindung.
Pour la série blu'box 52 connexion facile à défaire

Art-Nr./No d'article	Grösse/grandeur
4000379	GN/EN 52
4000514	GN 52

Preis/prix
552.70
552.70



BLU'MOBIL Board

Bis zu 2 blu'box 52 oder 3 blu'box 26 (voll bestückt), Maximale Tragkraft: 120 kg,
Gewicht: 6,5 kg, 2 Lenkrollen mit Feststellbremse, 2 Lenkrollen ohne Feststellbremse
Jusqu'à 2 blu'box 52 et 3 blu'box 26 (à plein charge), Charge max. 120 kg,
Poids: 6,5 kg, 4 roues, dont 2 avec freins

Art-Nr./No d'article	Grösse/grandeur
4000558	430 x 600 x H 170 mm

Preis/prix
329.15



BLU'MOBIL Easy Roll

Bis zu 2 blu'box 52 oder 3 blu'box 26 (voll bestückt), Maximale Tragkraft: 180 kg,
Gewicht: 15,2 kg, 2 Lenkrollen mit Feststellbremse, 2 Bockrollen
Jusqu'à 2 blu'box 52 et 3 blu'box 26 (à plein charge), Charge max. 180 kg
Poids: 15,2 kg, 2 rouleaux conduits, 2 rouleaux bloqués

Art-Nr./No d'article	Grösse/grandeur
4000497	565 x 765 mm x H 890 mm (inkl. Griff/poignée incl.)

Preis/prix
998.40

SPEISENTRANSPORT / TRANSPORT D'ALIMENTS

BLU'MOBIL
das neue roll- und stapelbare System der blu'line Serie
le nouveau système mobile et empilable de la série blu'line

Das neue stapel- und rollbare System blu'mobil 104 gn bietet vollkommene Mobilität und Anpassungsfähigkeit an die individuellen Ansprüche der Verteilung kalter und warmer Speisen. Fünf verschiedene Varianten, die allen Ansprüchen der Speisenverteilung gerecht werden. Die hochwertigen Heiztechnologien der selbstregelnden lite-Heizung und des regelbaren hot² Heizsystems erhitzen den Innenraum der Behälter schnell und zuverlässig auf bis zu +85° C. Das regelbare Heizsystem hot² lässt sich stufenlos von + 20° C bis + 85° C einstellen. Aufgrund der hervorragenden Isolierleistung der Behälter eignet sich auch die passive Variante für den Transport warmer Speisen.

Le nouveau système blu'mobil 104 gn empilable et mobile offre une mobilité et une adaptabilité complètes aux exigences individuelles de la distribution de nourriture froide et chaude. Cinq versions différentes qui répondent à toutes les exigences de la distribution alimentaire. Les technologies de chauffage de haute qualité du chauffage lite autoregule et du système de chauffage a chaleur 2 réglable chauffent l'intérieur des conteneurs rapidement et de manière fiable jusqu'à +85° C. Le système de chauffage hot² réglable peut être réglé en continu de +20° C à +85° C. En raison de l'excellente isolation des conteneurs, la variante passive convient également au transport de nourriture chaude.

x2
T13

BLU'MOBIL 104 GN
hot²

Temperatur beider Boxen über jeweiliges Display einstellbar (von +20° C bis +85° C), jeder Innenraum ist individuell heizbar, jeder Behälter ist einzeln nutzbar, insgesamt 24 GN-Einschübe (Bestückung 4 x GN 1/1 - 200 mm oder Unterteilungen)

Température des deux containers réglable via l'affichage respectif (de +20° C à +85° C), chaque intérieur peut être chauffé individuellement, chaque conteneur peut être utilisé individuellement, 24 unités GN coulissantes au total

Art-Nr./No d'article	Grösse/grandeur	Anschlusswert/puissance	Preis/prix
4000780	64,9 x 44,9 x H 132,1 cm / 44 kg	230 V / 500 W	4115.25

Muss Kundensseitig zusammgebaut werden.
Doit être assemblé par le client.

x2
T13

BLU'MOBIL 104 GN
lite

Innenraum beider Boxen wird automatisch auf ca. +80° C erhitzt (selbstregelnd), jeder Behälter ist einzeln nutzbar, Transport von bis zu 100 kg Lebensmitteln, insgesamt 24 GN-Einschübe (Bestückung 4 x GN 1/1 - 200 mm oder Unterteilungen)

L'intérieur des deux containers est automatiquement chauffé à environ +80° C (autorégulation), chaque conteneur peut être utilisé individuellement, transport de jusqu'à 100 kg de denrées alimentaires, 24 unités GN coulissantes au total

Art-Nr./No d'article	Grösse/grandeur	Anschlusswert/puissance	Preis/prix
4000779	64,9 x 44,9 x H 132,1 cm / 43 kg	230 V / 500 W	3410.00

Muss Kundensseitig zusammgebaut werden.
Doit être assemblé par le client.



**BLU'MOBIL 104 GN
passiv**

geeignet für den Transport kalter und warmer Speisen, hervorragende Isolierleistung, nachrüsten eines blu'box cool-accus möglich, insgesamt 24 GN-Einschübe (Bestückung 4 x GN 1/1 - 200 mm oder Unterteilungen)

convient pour le transport de denrées alimentaires froides et chaudes, une excellente performance d'isolation, possibilité de rééquiper une blu'box cool-accu

Art-Nr./No d'article	Grösse/grandeur	Anschlusswert/puissance	Preis/prix
4000765	64,9 x 44,9 x H 132,1 cm / 37 kg	230 V / 500 W	1998.00

Zubehör/Accessoires	Preis/prix
4000388 Cool-Accu	132.90

Muss Kundensseitig zusammengebaut werden.
Doit être assemblé par le client.



T13



**BLU'MOBIL 104 GN
hot² + passiv**

Temperatur des hot²-Behälters über Display einstellbar (von +20° C bis +85° C), jeder Behälter ist einzeln nutzbar, nachrüsten eines blu'box cool-accus möglich, insgesamt 24 GN-Einschübe (Bestückung 4 x GN 1/1 - 200 mm oder Unterteilungen)

Temperature du recipient hot²- réglable par affichage (de +20° C à +85° C, chaque conteneur peut être utilisé individuellement, possibilité de rééquiper une blu'box cool-accu

Art-Nr./No d'article	Grösse/grandeur	Anschlusswert/puissance	Preis/prix
4000778	64,9 x 44,9 x H 132,1 cm / 41 kg	230 V / 500 W	3292.70

Zubehör/Accessoires	Preis/prix
4000388 Cool-Accu	132.90

Muss Kundensseitig zusammengebaut werden.
Doit être assemblé par le client.



T13



**BLU'MOBIL 104 GN
lite + passiv**

Innenraum des lite-Behälters wird auf ca. +80° C erhitzt (selbstregelnd), jeder Behälter ist einzeln nutzbar, nachrüsten eines blu'box cool-accus möglich, insgesamt 24 GN-Einschübe (Bestückung 4 x GN 1/1 - 200 mm oder Unterteilungen)

L'intérieur du conteneur Lite est chauffé à environ +80° C (autorégulation), chaque conteneur peut être utilisé individuellement, possibilité de rééquiper une blu'box cool-accu

Art-Nr./No d'article	Grösse/grandeur	Anschlusswert/puissance	Preis/prix
4000777	64,9 x 44,9 x H 132,1 cm / 40 kg	230 V / 500 W	2821.15

Zubehör/Accessoires	Preis/prix
4000388 Cool-Accu	132.90

Muss Kundensseitig zusammengebaut werden.
Doit être assemblé par le client.



SPEISENTRANSPORT / TRANSPORT D'ALIMENTS

**BLU'THERM 10 liquid**

Ohne Tropfwanne
sans égouttoir

Art-Nr./No d'article Grösse/grandeur
4000581 36 x 25 cm x H 38,2 cm / 3,4 kg

Fassungsvermögen/capacité Preis/prix
10 L **529.15**

**BLU'THERM 10 liquid**

Mit Tropfwanne
avec égouttoir

Art-Nr./No d'article Grösse/grandeur
4000574 36 x 25 cm x H 48,2 cm / 4,5 kg

Fassungsvermögen/capacité Preis/prix
10 L **635.05**

**BLU'THERM 20 liquid**

Ohne Tropfwanne
sans égouttoir

Art-Nr./No d'article Grösse/grandeur
4000587 36 x 25,5 cm x H 60,3 cm / 6,4 kg

Fassungsvermögen/capacité Preis/prix
20 L **635.05**

**BLU'THERM 20 liquid**

Mit Tropfwanne
avec égouttoir

Art-Nr./No d'article Grösse/grandeur
4000591 36 x 25 cm x H 71,3 cm / 6,8 kg

Fassungsvermögen/capacité Preis/prix
20 L **729.15**



ISOBOX® Mobil Basic
niedrige Ausführung 1-türig
typ bas - 1 porte

HUPFER

Allseitig geschlossener Transportwagen in leichter und stabiler Sandwich-Bauweise aus Aluminium-Profilen. Grosse Flexibilität beim neutralen Transport von warmen und passiv gekühlten Speisen. Mit geschlossener Rückwand, 1 Fach, Höhenraster: 37,5 mm

Chariot de transport fermé de tous les côté, construction sandwich légère et stable en profilés d'aluminium. Grande flexibilité dans le transport neutre de repas chauds et le transport refroidi de manière passive de plats froids. Avec panneau arrière fermé, 1 compartiment, Module de hauteur : 37,5 mm

Art-Nr./No d'article	Grösse/grandeur	Kapazität/capacité
0223047	550 x 730 x 925 mm	15 x GN 1/1

Preise auf Anfrage. Weitere Farben auf Anfrage.
Prix sur demande. Autres couleurs sur demande.



ISOBOX® Mobil Flex
niedrige Ausführung 2-türig nebeneinander
typ bas - 2 portes côte à côte

HUPFER

Allseitig geschlossener Transportwagen in leichter und stabiler Sandwich-Bauweise aus Aluminium-Profilen. Grosse Flexibilität beim neutralen Transport von warmen und passiv gekühlten Speisen. Mit geschlossener Rückwand, 2 Fächer nebeneinander, Höhenraster: 37,5 mm

Chariot de transport fermé de tous les côté, construction sandwich légère et stable en profilés d'aluminium. Grande flexibilité dans le transport neutre de repas chauds et le transport refroidi de manière passive de plats froids. Avec panneau arrière fermé, 2 compartiments l'un à côté de l'autre, Module de hauteur : 37,5 mm

Art-Nr./No d'article	Grösse/grandeur	Kapazität/capacité
0223049	975 x 730 x 925 mm	30 x GN-1/1

Preise auf Anfrage. Weitere Farben auf Anfrage.
Prix sur demande. Autres couleurs sur demande.



ISOBOX® Mobil Flex
hohe Ausführung 2-türig übereinander
typ haut - 2 portes l'une sur l'autre

HUPFER

Allseitig geschlossener Transportwagen in leichter und stabiler Sandwich-Bauweise aus Aluminium-Profilen. Grosse Flexibilität beim neutralen Transport von warmen und passiv gekühlten Speisen. Mit geschlossener Rückwand, 2 Fächer übereinander, Höhenraster: 37,5 mm

Chariot de transport fermé de tous les côté, construction sandwich légère et stable en profilés d'aluminium. Grande flexibilité dans le transport neutre de repas chauds et le transport refroidi de manière passive de plats froids. Avec panneau arrière fermé, 2 compartiments l'un au-dessus de l'autre, Module de hauteur : 37,5 mm

Art-Nr./No d'article	Grösse/grandeur	Kapazität/capacité
0223050	550 x 730 x 1640 mm	30 x GN-1/1

Preise auf Anfrage. Weitere Farben auf Anfrage.
Prix sur demande. Autres couleurs sur demande.



ISOBOX® Mobil Flex
hohe Ausführung 1-türig
typ haut - 1 porte

HUPFER

Allseitig geschlossener Transportwagen in leichter und stabiler Sandwich-Bauweise aus Aluminium-Profilen. Grosse Flexibilität beim neutralen Transport von warmen und passiv gekühlten Speisen. Mit geschlossener Rückwand, 1 Fach (hohe Ausführung), Höhenraster: 37,5 mm

Chariot de transport fermé de tous les côté, construction sandwich légère et stable en profilés d'aluminium. Grande flexibilité dans le transport neutre de repas chauds et le transport refroidi de manière passive de plats froids. Avec panneau arrière fermé, 1 compartiment (exécution haute), Module de hauteur : 37,5 mm

Art-Nr./No d'article	Grösse/grandeur	Kapazität/capacité
0223048	550 x 730 x 1490 mm	30 x GN-1/1

Preise auf Anfrage. Weitere Farben auf Anfrage.
Prix sur demande. Autres couleurs sur demande.

HUPFER

ISOBOX® Mobil Flex
niedrige Ausführung 1-türig
typ bas - 1 porte
 57,5 x 79,9 x H 92,6 cm

Längseinschub. Bei diesem Modell kein Heizmodul 800W einsetzbar.
 Galerie auf Anfrage.
Tiroir longitudinal. Pour ce types n'existe pas de module de chauffage 800W.
 Galerie sur demande.

Art-Nr./No d'article	Sicken/glissières	Kapazität/capacité
IBM 1/8 75	75 mm	8 x GN 1/1
IBM 1/15 37,5	37,5 mm	15 x GN 1/1

Preise auf Anfrage
 Prix sur demande

HUPFER

ISOBOX® Mobil Flex
niedrige Ausführung 2-türig nebeneinander
typ bas - 2 portes côte à côte
 106,4 x 79,9, x 95,9 cm

Längseinschub. Bei diesem Modell kein Heizmodul 800W einsetzbar.
 Galerie auf Anfrage.
Tiroir longitudinal. Pour ce types n'existe pas de module de chauffage 800W.
 Galerie sur demande.

Art-Nr./No d'article	Sicken/glissières	Kapazität/capacité
IBM /H2/16 75	75 mm	16 x GN 1/1
IBM /H2/30 37,5	37,5 mm	30 x GN 1/1

Preise auf Anfrage
 Prix sur demande

HUPFER

ISOBOX® Mobil Flex
hohe Ausführung 2-türig übereinander
typ haut - 2 portes l'une sur l'autre
 57,5 x 79,9 x H 166,7 cm

Längseinschub. Bei diesem Modell kein Heizmodul 800W einsetzbar.
 Galerie auf Anfrage.
Tiroir longitudinal. Pour ce types n'existe pas de module de chauffage 800W.
 Galerie sur demande.

Art-Nr./No d'article	Sicken/glissières	Kapazität/capacité
IBM /V2/16 75	75 mm	16 x GN 1/1
IBM /V2/30 37,5	37,5 mm	30 x GN 1/1

Preise auf Anfrage
 Prix sur demande

HUPFER

ISOBOX® Mobil Flex
hohe Ausführung 1-türig
typ haut - 1 porte
 57,5 x 79,9 x H 166,7 cm

Längseinschub. Bei diesem Modell nur Neutralabdeckung oder Heizmodul 800W einsetzbar. Galerie auf Anfrage.
Tiroir longitudinal. Pour ce type seulement utiliser la barriere neutre ou le module de chauffage 800W.
 Galerie sur demande.

Art-Nr./No d'article	Sicken/glissières	Kapazität/capacité
IBM 1/16 75	75 mm	16 x GN 1/1

Preise auf Anfrage
 Prix sur demande



ISOBOX® Mobil Flex ist ein Transportgerät mit dem kalte und warme Speisen in Grossgebinden oder auf Tablett flexibel und zuverlässig transportiert, verteilt und warm- und kaltgehalten werden können. **ISOBOX® Mobil Flex** besteht aus bis zu zwei Fächern, die durch in die Rückwand der Fächer einhängbare und zwischen den Fächern austauschbare Heiz- und Kühlmodule wahlweise neutral, beheizt oder gekühlt betrieben werden können.

ISOBOX® Mobil Flex est un chariot pour le transport et la distribution de repas froids et chauds, en vrac ou sur plateaux et retient le chaud et le froid. ISOBOX® Flex Mobil comprend jusqu'à deux compartiments qui sont équipés de modules échangeables chauffants ou refroidissants suspendus dans le fond du compartiment et entre les compartiments.

Der Innenraum kann innerhalb kurzer Zeit auf + 94 ° C erhitzt oder auf + 1° bis + 5° C heruntergekühlt werden. Optional kann die ISOBOX® mit einem Akku betrieben werden.

L'intérieur peut être rapidement chauffé à + 94° C ou refroidi à + 1° à 5° C. En option, ISOBOX® peut être équipé d'un accu.



T13

**HUPFER**

Kühlmodul Module de refroidissement

Das Kühlmodul einhängen und der Innenraum wird in kurzer Zeit auf +4°C heruntergekühlt. Die Temperatur ist präzise mit Digitalregler einstellbar.

Accrocher le module de refroidissement et l'intérieur est refroidi à +4°C en un rien de temps.

La température peut être réglée précisément avec un régulateur numérique.

Art-Nr./No d'article

0163796 150W

230 V

Preise auf Anfrage
Prix sur demande



T13

**HUPFER**

Wärmemodul Module de chauffage

Innerhalb kürzester Zeit wird der Innenraum auf maximal 100°C erhitzt. Die Temperatur ist präzise mit Digitalregler einstellbar - für optimale Temperaturkontrolle

En un rien de temps l'intérieur est chauffé au 100°C max. La température peut être réglée précisément avec un régulateur numérique pour obtenir un contrôle optimal de la température.

Art-Nr./No d'article

0163790 400W

230 V

0163793 800W

230 V

Preise auf Anfrage
Prix sur demande

HUPFER

Neutralabdeckung La barrière neutre

Neutralabdeckung in Modulgrösse.

La barrière neutre en taille des modules.

Art-Nr./No d'article

0163862

Preise auf Anfrage
Prix sur demande

Mobile, on-the-spot Frühstücksverpflegung

Distribution de petits-déjeuners mobile et sur place

Mit dem Frühstückswagen präsentieren wir Ihnen eine innovative Entwicklung zur Patientenverpflegung und zur Steigerung der Kosten- und Zeiteffizienz in Schweizer Spitälern, nicht zu vergessen natürlich auch die Qualitätssteigerung des Frühstücks direkt bei den Patienten auf den Stationen. Bereits wurde der Frühstückswagen in verschiedenen Spitälern auf Herz und Nieren getestet.

Avec ce chariot de petit-déjeuner, nous vous présentons une évolution innovante pour la restauration des patients avec un gain de temps et d'argent dans les hôpitaux suisses, sans oublier bien sûr l'amélioration de la qualité des petits-déjeuners directement distribués aux patients sur les stations. Le chariot de petit-déjeuner a déjà fait l'objet de tests rigoureux dans différents hôpitaux.

Technische Facts

- Masse 1610 x 895 x H 1617 mm
- Höhe Arbeitsplatte: 997 mm
- Gewicht ca. 285 kg
- Kühlung: Kompressorkühlung mit Luftumwälzung, 250W Kälteleistung, Natürliches Kühlmittel R 290
- Bi-Direktionaler Wechselrichter mit einem maximalen Stromabgang von 3000W bei 230V
- 2 Lithium-Eisenphosphat-Batterien mit einer Nennspannung von 12,8 V Kapazität 90Ah in Serie.

Données techniques

- Dimensions: 1610 x 895 x H 1617 mm
- Hauteur plan de travail: 997 mm
- Poids env. 285 kg
- Réfrigération: réfrigération par compression avec circulation d'air, puissance frigorifique 250 W, agent réfrigérant naturel R 290
- Onduleur bidirectionnel avec sortie de courant maximale de 3 000 W pour 230 V
- 2 accumulateurs lithium fer phosphate avec une tension nominale de 12,8 V, capacité 90 Ah en série.



Preise auf Anfrage
Prix sur demande

Produkthighlights

- **Akkusystem, welches es erlaubt eine Profi-Kaffeemaschine zu betreiben oder Wahlweise jedes andere Gerät mit max. 3000 W und 230 V**
- **Aktives Kühlsystem mit Kompressor-Umluftkühlung**
- **Einfaches Geschirr-Handling in Körben 500 x 500 mm**
- **Der Wagen ist Modular und kann auf Kundenwunsch konfiguriert werden**
- **100% Swiss Made**

Mit dem Kauf des «Frühstückswagen by Berndorf» erhalten Sie einen kompletten Modellprozess zur direkten Integration in Ihre Prozessstruktur/ISO.

Points forts du produit

- Système de batteries permettant d'utiliser une machine à café professionnelle ou tout autre appareil au choix avec 3000 W et 230 V max.
- Système réfrigérant actif avec réfrigération par compression à air pulsé
- Manipulation facile de la vaisselle dans des paniers 500 x 500 mm
- Le chariot est modulable et peut être configuré selon les souhaits des clients.
- 100 % Swiss Made

Avec l'achat du «chariot petit déjeuner by Berndorf», vous recevrez un processus complet pour une intégration directe dans votre structure de processus / ISO.

SPEISENTRANSPORT / TRANSPORT D'ALIMENTS

Die Vorteile gegenüber dem bisherigen Frühstücksservice:

- Durch den just-in-time/on-the-spot Frühstücksservice entsteht deutlich weniger Food Waste, da der Patient nun explizit nur dasjenige wählt, was er jetzt tatsächlich essen möchte.
- Kurzfristig eintretende Patienten können ohne Mehraufwand mit einem Frühstück verpflegt werden.
- Dank einer integrierten Kaffeemaschine kann man die Patienten mit einem frisch zubereiteten Kaffee begeistern.
- Die Mitarbeitenden können mehr Serviceleistung erbringen und sind somit näher beim Patienten.
- Bestellaufwand am Vortag fürs Frühstück entfällt.
- Bestückung des Wagens muss nicht mehr am Band passieren, sondern kann am Vortag vorgenommen werden.

Les avantages par rapport aux anciens services de petit-déjeuner:

- Le service de petit-déjeuner juste-à-temps/sur place permet une réduction du gaspillage de nourriture, puisque le patient choisit uniquement ce qu'il souhaite réellement manger.
- Les patients hospitalisés pour une courte durée peuvent recevoir un petit-déjeuner sans surcoût.
- Grâce à une machine à café intégrée, les patients peuvent savourer un café fraîchement préparé.
- Les employés peuvent être plus performants tout en étant plus proches des patients.
- Le travail de la veille lié à la gestion des commandes est superflu.
- Il n'est plus nécessaire de remplir le chariot à la chaîne, le garnissage peut s'effectuer la veille.



Sensorgesteuerter Antrieb
für einfaches manövrieren ohne Kraftaufwand

Moteur contrôlé par capteur pour manœuvrer sans effort



Kontroll-Panel für Antrieb
mit Not-Aus-Schalter

Panneau de contrôle de l'entraînement avec interrupteur d'arrêt d'urgence



Akkusystem
Anzeige der Ladestände auf einem Infodisplay

Système de batteries affichage du niveau de charge sur un écran d'information



Kühlregler/Kühlanzeige
zur Steuerung der Kompressorkühlung

Régulateur/affichage de la réfrigération pour la réfrigération par compression



3 GN-Schubladen, davon 2 gekühlt
zur Aufnahme von GN 1/1 - 150 mm

3 tiroirs GN dont 2 réfrigérés pour la mise en place de GN 1/1 - 150 mm



4 Geschirr-Schubladen
zur Aufnahme von Geschirrkörben 500 x 500 mm

4 tiroirs à vaisselle pour la mise en place de paniers à vaisselle 500 x 500 mm



Autarker Gerätebetrieb
für Geräte mit max. 3000 W und 230 V

Fonctionnement autonome pour des appareils avec 3000 W et 230 V max.



Zutenaufsatz
Zubehör direkt Griffbereit in GN-Behältern

Compartiment pour ingrédients accessoires à portée de main dans des récipients GN



Abfallbehälter
zur Trennung von Bio- und Restmüll

Poubelles pour le tri des déchets organiques et résiduels

SPEISENTRANSPORT / TRANSPORT D'ALIMENTS

HUPFER

0161470
0164197
0164198

T13

0164199

T23



0161470

0164197

0164198

0164199

Speisenausgabewagen
Chariot bain-marie

Aus Inox. Die Speisenausgabewagen von HUPFER® sind ein wichtiger Bestandteil der Gemeinschaftsverpflegung. Diese Produkte unterstützen ganz wesentlich Abläufe in der Speisenverteilung und gestalten diese dadurch effizienter.
En inox. Le chariot bain-marie de HUPFER® est un élément clé de l'alimentation collective. Ces produits soutiennent et rationalisent essentiellement les déroulements dans le conditionnement de repas.

Art.-Nr. No d'article	Aussenmasse dimension	Anschlusswert puissance	Beckenanzahl nombre de cuve	Kapazität capacité	Preis prix
0161470	67,8 x 60,6 x H 90 cm	230 V / 0,7 kW	1	15 Pers.	1998.55
0164197	67,8 x 92,6 x H 90 cm	230 V / 1,4 kW	2	25 Pers.	2585.00
0164198	67,8 x 127,6 x H 90 cm	230 V / 2,1 kW	3	50 Pers.	3057.40
0164199	67,8 x 162,5 x H 90 cm	230 V / 2,8 kW	4	80 Pers.	3998.55

HUPFER



T23



0162943

0162946

Speisentransportwagen mit Becken
Chariot bain marie sur étuve

Aus Inox. Speisentransportwagen in beheizter Ausführung für Transport, Ausgabe und Bevorratung von zubereiteten Speisen in GN-Behältern. Ohne Deckel, mit Folienheizung für Warmhaltebecken, mit Becken für GN-Behälter bis 200 mm Höhe, mit Wärmeschränken für GN 1/1
En inox. Chariot de transport de repas en exécution chauffante pour le transport, la distribution et le stockage de plats préparés dans des récipients GN. Sans couvercle, avec système de chauffage par feuilles pour bac chauffant, avec 2 bacs pour récipient GN jusqu'à 200 mm de hauteur, avec armoires chauffantes pour GN 1/1

Art.-Nr./No d'article	Grösse/grandeur	Anschluss/puissance	Kapazität/capacité	Preis/prix
0162943	70 x 92,2 x H 97,4 cm	230 V / 2,3 kW	25 Pers.	6468.40
0162946	70 x 131,7 x H 97,4 cm	230 V / 3,45 kW	50 Pers.	8938.80

Zubehör/Accessoires

0163584	Kältespeicherplatte 53 x 32,5 cm x H 3 cm Plaques accumulation de froid			199.70
----------------	--	--	--	---------------

HUPFER



T23



0162945

0162948

Speisentransportwagen mit Schiebedeckel
Chariot bain marie sur étuve avec couvercle coulissant

Speisentransportwagen in beheizter Ausführung für Transport, Ausgabe und Bevorratung von zubereiteten Speisen in GN-Behältern. Wagen in stabiler, selbsttragender und hygienischer Konstruktion aus hochwertigem Edelstahl. Mit Schiebedeckel, mit Folienheizung für Warmhaltebecken, mit Becken für GN-Behälter bis 200 mm Höhe, mit Wärmeschränken für GN 1/1
Chariot de transport de repas en exécution chauffante pour le transport, la distribution et le stockage de plats préparés dans des récipients GN. Chariot à structure solide, monocoque et hygiénique en acier inoxydable haut de gamme. Avec couvercle coulissant, avec système de chauffage par feuilles pour bac chauffant, avec 2 bacs pour récipient GN jusqu'à 200 mm de hauteur, avec armoires chauffantes pour GN 1/1

Art.-Nr./No d'article	Grösse/grandeur	Anschluss/puissance	Kapazität/capacité	Preis/prix
0162945	79,5 x 100/174,5 cm H 106,1 cm	230 V / 2,3 kW	25 Pers.	8938.80
0162948	79,5 x 139,3/253,3 cm H 106,1 cm	230 V / 3,45 kW	50 Pers.	11'610.00

Zubehör/Accessoires

0163584	Kältespeicherplatte 53 x 32,5 cm x H 3 cm Plaques accumulation de froid			199.70
----------------	--	--	--	---------------



T23

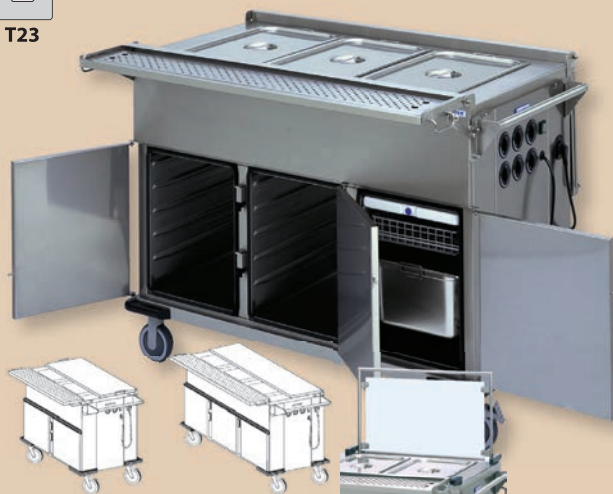

0162944



0162947



0162629

HUPFER

Speisentransportwagen mit Klappdeckel Chariot bain marie sur étuve avec couvercle rabattable

Speisentransportwagen in beheizter Ausführung für Transport, Ausgabe und Bevorratung von zubereiteten Speisen in GN-Behältern. Wagen in stabiler, selbsttragender und hygienischer Konstruktion aus hochwertigem Edelstahl. Mit Folienheizung für Warmhaltebecken, mit Becken für GN-Behälter bis 200 mm Höhe, mit Wärmeschranken für GN 1/1
Chariot de transport de repas en exécution chauffante pour le transport, la distribution et le stockage de plats préparés dans des récipients GN. Chariot à structure solide, monocoque et hygiénique en acier inoxydable haut de gamme. Avec système de chauffage par feuilles pour bac chauffant, avec 2 bacs pour récipient GN jusqu'à 200 mm de hauteur, avec armoires chauffantes pour GN 1/1

Art-Nr./ No d'article	Aussenmasse/dimension	Anschluss/puissance	Kapazität/capacité	Preis/prix
0162944	94,5 x 72,9 x 104,3 cm / 90 kg	230 V / 2,3 kW	25 Pers.	8211.75
0162947	131,5 x 72,9 x 104,3 cm / 125 kg	230 V / 3,45 kW	50 Pers.	9880.00

Zubehör/Accessoires

0162629	Hauchschutz versenkbar (für 0162944) Pare-haleine escamotable (pour 0162944)	auf Anfrage sur demande
0163584	Kältespeicherplatte 53 x 32,5 cm x H 3 cm Plaques accumulation de froid	199.70

HUPFER



Husten- und Spuckschutz für GN-1/1-Behälter Écran contre la toux pour récipient GN 1/1

Aufsteller aus Plexiglas als mobiler Husten- und Spuckschutz. Masse abgestimmt auf 1/1 GN-Behälter. Aufstellung sowohl liegend als auch stehend möglich. Reinigung in der Spülmaschine möglich.
Présentoir en plexiglas faisant écran mobile contre la toux et les postillons. Dimensions convenant aux réservoirs GN 1/1. Positionnement possible à plat ou debout. Nettoyage au lave-vaisselle possible.

Art-Nr./ No d'article	Aussenmasse/dimension	Preis/prix
0164570	34,5 x 17,5 x H 12 cm	69.35

HUPFER



Kältespeicherplatte Plaques accumulation de froid

Eutektische Platte zum Kalthalten von vorgekühlten Speisenkomponenten. Polyethylen, Mit Grifflöchern, Spülmaschinen-tauglich.
Plaque eutectique pour le maintien au froid des composants alimentaires prérefroidis. Polyéthylène, avec trous de préhension, compatible lave-vaisselle.

Art-Nr./ No d'article	Aussenmasse/dimension	Preis/prix
0163584	GN 1/1 - 53 x 32,5 cm x H 3 cm	199.70



T13

**HUPFER**

Bankettwagen beheizt Chariot banquet chauffant

Aus Inox. Die HUPFER® Bankettwagen sind kompakte Lösungen, um sehr effektiv auch vorportionierte Speisen für den Einsatz beim Gast bereitzustellen. Das schnelle Erreichen der Zieltemperatur, hohe technische Leistung bei geringem Energieeinsatz und das in kompakten Ausmassen, das sind die Merkmale, weshalb diese Bankettwagen so erfolgreich im Markt sind. +30° bis + 95°C

En inox. Le chariot banquet de HUPFER® est une solution compacte pour mettre des repas préparés à la disposition du convive. Puisqu'ils atteignent vite la température finale et grâce à la haute performance technique avec faibles besoins en énergie et tout ça en dimensions compactes, nos chariots banquets ont beaucoup de succès. +30° à + 95°C

Art.-Nr./ No d'article	Aussenmasse/dimension	Anschlusswert/puissance	Kapazität/capacité	Preis/prix
0163291	58,8 x 72,2 x H 125,7 cm	230 V / 1,6 kW	14 x GN 1/1	7291.50
0163292	58,8 x 72,2 x H 160,2 cm	230 V / 1,6 kW	20 x GN 1/1	8211.75
0163293	79,3 x 84,2 x H 151,7 cm	230 V / 1,6 kW	18 x GN 2/1	9880.00



T13



Bankettwagen passiv gekühlt und beheizt Chariot banquet réfrigère passiv et rechauffé

HUPFER

Aus Inox. Die HUPFER® Bankettwagen sind kompakte Lösungen, um sehr effektiv auch vorportionierte Speisen für den Einsatz beim Gast bereitzustellen. Ob kalte oder warme Speisen – HUPFER® hält die gewünschte Gerätelinie bereit. Das schnelle Erreichen der Zieltemperatur, hohe technische Leistung bei geringem Energieeinsatz und das in kompakten Ausmassen, das sind die Merkmale, weshalb diese Bankettwagen so erfolgreich im Markt sind.

En inox. Le chariot banquet de HUPFER® est une solution compacte pour mettre des repas préparés à la disposition du convive. N'importe de quelle sorte de repas (chaud/froid) il s'agit, HUPFER® fournit la ligne de chariot désirée. Puisqu'ils atteignent vite la température finale et grâce à la haute performance technique avec faibles besoins en énergie et tout ça en dimensions compactes, nos chariots banquets ont beaucoup de succès.

Art.-Nr./ No d'article	Aussenmasse/dimension	Anschlusswert/puissance	Kapazität/capacité	Preis/prix
0163294	64,0x 77,5x H 185,8 cm	230V /1,6 kW	14x GN 1/1	9880.00
0163282	79,5x 89,5x H 189,2 cm	230V /1,6 kW	20x GN 1/1	11610.00

Zubehör/Accessoires

0163584	Kältespeicherplatte 53 x 32,5 cm x H 3 cm Plaques accumulation de froid	199.70
----------------	--	---------------

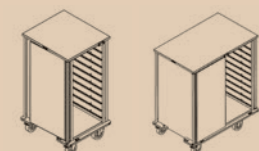

Tablett-Transportwagen Chariot de transport plateaux

HUPFER

Aus Inox. Doppelwandige, verschweisste Tablett-Transportwagen – je nach Erfordernis hält HUPFER® die richtige Produktlösung bereit. Um tablettierte Speisenkomponenten besonders wirtschaftlich zu transportieren, stehen dem Nutzer alle Varianten bis hin zur waschanlagentauglichen Version zur Verfügung. Ein Vorteil für grosse Häuser, die hiermit sehr wirtschaftlich den höchsten Hygienestandard erreichen.

En inox. HUPFER® vous prépare la solution juste selon vos exigences – chariots double paroi, chariots soudés. Pour transporter les plateaux de repas surtout économiquement, toutes les variantes jusqu'à la version appropriée à la station de lavage sont disponibles. Un avantage pour les grandes maisons qui ainsi arrivent très économiquement au standard hygiénique le plus haut.

Art.-Nr./ No d'article	Grösse/grandeur	Kapazität/capacité
0161919	77,5 x 95,2 cm x H 156,1 cm	2 x 10 EN-Tabletts
0161929	136,9 x 89,2 cm x H 133,1 cm	2 Abteile, je 2 x 8 EN-Tabletts
0161939	135,3 x 83,4 cm x H 156,2 cm	2 Abteile, je 2 x 10 EN-Tabletts

Preise auf Anfrage
Prix sur demande

SPÜLKÖRBE / CORBEILLES DE LAVAGE



Verlangen Sie unsere Fachberatung für Gläserkörbe
 Demandez nos conseils professionnels pour les corbeilles à verres
 info@victor-meyer.ch
 T 041 462 72 72



FRIES
Grundkorb weitmaschig
Panier de base maillage large

Art-Nr./No d'article	Korbgrösse/dimension	Höhe/hauteur	Preis/prix
650001300	500 x 500 mm	73 mm	52.90
650029300	500 x 500 mm	110 mm	76.45
650056300	500 x 500 mm	160 mm	76.45
650057300	500 x 500 mm	210 mm	84.65



FRIES
Tellerkorb
Panier à assiettes

für 16 flache oder 12 tiefe Teller
 pour 16 assiettes plates ou 12 assiettes creuses

Art-Nr./No d'article	Korbgrösse/dimension	Preis/prix
650020300	500 x 500 mm	52.90



FRIES
Tellerkorb
Panier à assiettes

für 18 flache oder 12 tiefe Teller
 pour 18 assiettes plates ou 12 assiettes creuses

Art-Nr./No d'article	Korbgrösse/dimension	Preis/prix
655119300	500 x 500 mm	52.90

SPÜLKÖRBE / CORBEILLES DE LAVAGE

FRIES
Tassenkorb
Panier à tasse

Korb mit Schrägstellung für 20 Tassen, Höhere Körbe auf Anfrage.
Panier position inclinée pour 20 tasses, panier plus haut sur demande

Art-Nr./No d'article Korbgrösse/dimension
610450080 500 x 500 mm

Preis/prix
75.25

FRIES
Besteckkorb engmaschig
Panier à couverts de table, maillage étroit

Art-Nr./No d'article Korbgrösse/dimension
650019300 500 x 500 mm

Preis/prix
52.90

FRIES
Besteckköcher
Godet à couverts de table

pyramidenförmiger Becher zur besseren Auffächerung des Bestecks
Panier forme pyramidale pour une meilleure répartition des couverts

Art-Nr./No d'article Grösse/grandeur
655118300 106 x 106 x H 140 mm

Preis/prix
3.50

FRIES
Besteckköcher
Godet à couverts de table

Art-Nr./No d'article Korb 4fach ohne Bügel
655120300 *Panier de 4 sans support*
655121300 Halter einzeln mit Bügel
 Support individuel

Preis/prix
22.30

7.05

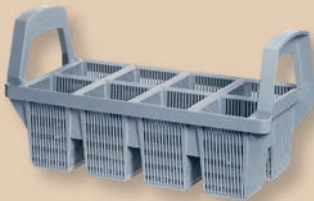
FRIES
Besteckkorb Silverstar
Panier à couverts de table Silverstar

mit Griffen, Passend in Grundkorb NK
avec poignées, pour panier de base NK

Art-Nr./No d'article Grösse/grandeur
655117300 450 x 212 x H 260 mm

Preis/prix
27.00



FRIES
Tablettkorb
Panier à plateaux

für 8 grosse Tablett GN/EN 1/1, mit Nicro-Schiene verstärkt
pour 8 plateaux GN/EN 1/1, renforcé d'un rail Nicro

Art-Nr./No d'article Korbgrösse/dimension
650002300 500 x 500 mm

Preis/prix
75.25

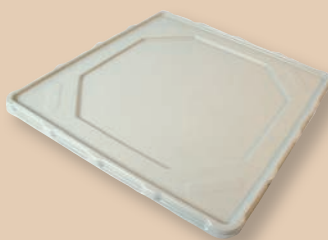
SPÜLKÖRBE / CORBEILLES DE LAVAGE



Thekenabtropfwanne Cuve égouttoir amovible

Thekenabtropfwanne als Abtropfwanne oder Schutzdeckel einsetzbar.
Bac de rétention ou couvercle de protection

Art-Nr./No d'article Korbgröße/dimension
650008300 500 x 500 mm

Preis/prix
82.20

Abtropfwanne für Transportwagen
Cuve égouttoir pour chariot de transport

Art-Nr./No d'article Aussenmasse/dimensions
650008400 500 x 500 mm

Preis/prix
82.20



Schutzhülle Housse de protection

für einen Korbstapel, mit 2 Reisverschlüssen.
pour couvrir les paniers empilés, 2 fermetures éclair

Art-Nr./No d'article Aussenmasse/dimensions
650009300 54 x 54 x 160 cm

Preis/prix
105.70



Transportwagen mit Wanne Chariot de transport avec bac

Rolli mit 4 Lenkrollen Chariot avec 4 roulettes pivotantes

Art-Nr./No d'article
650006300

Nutzlast/charge utile
- 250 kg

Preis/prix
282.10

Rolli mit 4 Lenkrollen und Schubbügel Chariot avec 4 roulettes pivotantes et arceau de guidage

Art-Nr./No d'article
650007300

Nutzlast/charge utile
- 250 kg

Preis/prix
611.50



Korbroller mit Wanne und Griff Chariot à paniers avec bac et poignée

Vollständig aus Inox, für Körbe 500 x 500 mm, 4 Lenkrollen, Ø 125 mm, in korrosionsgeschützten Gehäusen, davon 2 mit Totalfeststellern.
En inox, pour corbeilles 500 x 500 mm, bac résistant à la corrosion, 4 roues pivotantes Ø 125 mm dont 2 avec frein.

Art-Nr./No d'article Aussenmasse/dimensions
0119350 61 x 52 cm x H 20,5/79,5 cm

Preis/prix
586.80



Doppelkorbrolli Chariot double pour corbeilles

mit zwei Schubbügel, für zwei Korbstapel 500 x 500 mm Körbe, 2 Lenkrollen, 2 Bockrollen mit Feststeller
avec 2 barres de poussée, pour 2 rangées de paniers 500 x 500, 2 roues pivotantes et 2 avec frein.

Art-Nr./No d'article
650007400

Preis/prix
1644.75

SPÜLKÖRBE / CORBEILLES DE LAVAGE

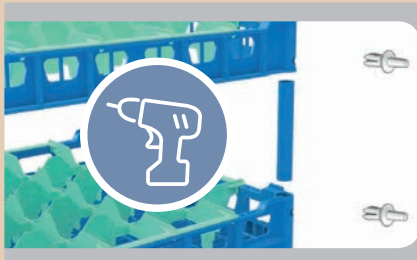

«Customrack 500»
Erhöhte Stabilität durch
Rohrmontage.
Stabilité accrue grâce
à l'assemblage à tubes.



«Clixrack 500»
Umrüstbar dank
Klick-System.
Convertible grâce
au Click-Système.

FRIES
Gläserkörbe für gerade stehende Gläser
Casiers à verres pour verres en position verticale
500 x 500 mm

«Customrack 500»

Standardfarbe blau, Toprahmenfarbe wählbar. Erhöhte Stabilität durch Rohrmontage (Fixe Verschraubung der Komponenten). Die Höhe des Korbes kann präzise an die Glashöhe angepasst werden bis zu 290 mm.
Couleur du cadre bleu standard, celle des casiers au choix. Plus de stabilité car la plupart des composants sont visés. La hauteur du panier peut être ajustée précisément à la hauteur des verres jusqu'à 290 mm.

«Clixrack 500»

Standardfarbe grau, Toprahmenfarbe wählbar. Mit dem «Clix-Extender» als variables Höhen-Bindeglied zwischen den Komponenten, passen sich die Körbe Ihren Gläsern perfekt an. Ein späterer Korbumbau ist möglich. Erhältlich in 11 Standardhöhen von 73-260 mm.
Couleur du cadre gris standard, celle des casiers au choix. Le «Clix-Extender» forme un quadrillage de casiers d'une hauteur variable qui s'adapte à tous les verres. Un changement ultérieur est toujours possible. Disponible en 11 hauteurs standard de 73-260 mm.

Facheinteilungen
Répartition des cases

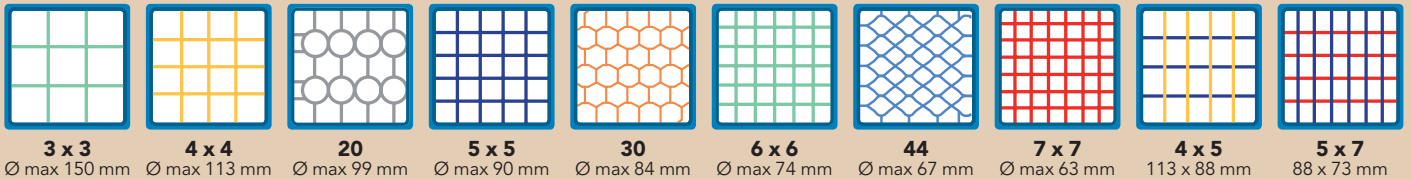

Farbcodierung
Codage de couleurs

Toprahmen erhältlich in 7 Farben zur zusätzlichen Unterscheidung der Gläserkörbe (im Preis inbegriffen). Auf Wunsch können die Körbe mit Farbclips versehen werden (gegen Aufpreis).
Cadre disponible en 7 couleurs pour mieux distinguer les paniers de lavage (inclus dans le prix). Sur demande, les paniers peuvent être équipés de clips en couleur (exclus dans le prix).



FRIES «Customrack 500»

«Typ A»

Glashöhe bis 73 mm
Korb mit einer Facheinteilung
Hauteur jusqu'à 73 mm
Casier avec une séparation

Einteilung/Répartition
3x3, 4x4, 20, 5x5, 30, 6x6, 44, 7x7, 4x5, 5x7

Preis/Prix
70.45



FRIES «Customrack 500»

«Typ B»

Glashöhen: 100, 110, 120, 130 mm
Korb mit Toprahmen und einer Facheinteilung
Hauteur jusqu'à 100, 110, 120, 130 mm
Casier avec cadre supérieur et une séparation

Einteilung/Répartition
3x3, 4x4, 20, 5x5, 30, 6x6, 44, 7x7, 4x5, 5x7

Preis/Prix
90.55

SPÜLKÖRBE / CORBEILLES DE LAVAGE



FRIES «Customrack 500»

«Typ B2»

Glashöhen: 110, 120, 130 mm

Korb mit Toprahmen und einer zweiten kurzen Facheinteilung

Hauteur jusqu'à 110, 120, 130 mm

Casier avec cadre supérieur et deuxième courte séparation

Einteilung/Répartition
3x3, 4x4, 5x5, 6x6, 3x4, 4x5, 7x7, 5x6, 5x7

Preis/Prix
116.40



FRIES «Customrack 500»

«Typ C»

Glashöhen: 140, 150, 160, 170, 180 mm

Korb mit Toprahmen und zwei Facheinteilungen

Hauteur jusqu'à 140, 150, 160, 170, 180 mm

Casier avec cadre supérieur et deux séparations

Einteilung/Répartition
3x3, 4x4, 20, 5x5, 30, 6x6, 44, 7x7, 4x5, 5x7

Preis/Prix
116.40

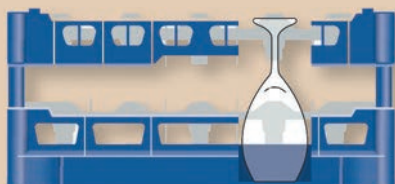

FRIES «Customrack 500»

«Typ CH»

Glashöhen: 180, 190, 200, 210, 220, 230 mm

Korb mit Toprahmen hoch und zwei Facheinteilungen

Hauteur jusqu'à 180, 190, 200, 210, 220, 230 mm

Casier avec cadre supérieur haut et deux séparations

Einteilung/Répartition
3x3, 4x4, 20, 5x5, 30, 6x6, 44, 7x7, 4x5, 5x7

Preis/Prix
105.70



FRIES «Customrack 500»

«Typ D»

Glashöhen: 190, 200, 210, 220, 230, 240 mm

Korb mit Toprahmen, Zwischenrahmen und zwei Facheinteilungen

Hauteur jusqu'à 190, 200, 210, 220, 230, 240 mm

Casier avec cadres supérieur et intermédiaire, deux séparations

Einteilung/Répartition
3x3, 4x4, 20, 5x5, 30, 6x6, 44, 7x7, 4x5, 5x7

Preis/Prix
116.40

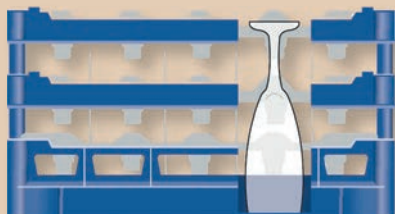

FRIES «Customrack 500»

«Typ D3»

Glashöhen: 210, 220, 230, 240, 250, 260, 270, 280, 290 mm

Korb mit Toprahmen, Zwischenrahmen und drei Facheinteilungen

Hauteur jusqu'à 210, 220, 230, 240, 250, 260, 270, 280, 290 mm

Casier avec cadres supérieur et intermédiaire, trois séparations

Einteilung/Répartition
3x3, 4x4, 20, 5x5, 30, 6x6, 44, 7x7, 4x5, 5x7

Preis/Prix
141.00



FRIES GN-Flanken Flancs GN

Auf Anfrage: Der Korb kann dank GN-Flanken direkt in die Gastronorm-Einschübe eingeführt werden.

Sur demande: le panier de lavage peut être introduit, grâce aux bords GN, directement sur les glissières GN.

SPÜLKÖRBE / CORBEILLES DE LAVAGE



«Clixrack 500»
Umrüstbar dank
Klick-System.
Convertible grâce
au Click-Système.

«Clixrack 500»

Standardfarbe grau, Toprahmenfarbe wählbar. Mit dem «Clix-Extender» als variables Höhen-Bindeglied zwischen den Komponenten, passen sich die Körbe Ihren Gläsern perfekt an. Ein späterer Korbumbau ist möglich. Erhältlich in 11 Standardhöhen von 73-260 mm.
Le couleur standard est gris, couleur de cadre sélectionnable. Avec le «Clix-Extender» en forme d'une passerelle à hauteur variable entre les composants les paniers s'assimilent parfaitement à leurs verres. Une restructuration des paniers plus tard est possible.

**FRIES «Clixrack 500»****«Typ A»**

Glashöhen bis 73 mm
Korb mit einer Facheinteilung
Hauteur jusqu'à 73 mm
Casier avec une séparation

Einteilung/Répartition
3x3, 4x4, 20, 5x5, 30, 6x6, 44, 7x7, 4x5, 5x7

Preis/Prix
70.45

**FRIES «Clixrack 500»****«Typ I»**

Glashöhen bis 120 mm
Korb mit Toprahmen und einer Facheinteilung
Hauteur jusqu'à 120 mm,
Casier avec cadre supérieur et une séparation

Einteilung/Répartition
3x3, 4x4, 20, 5x5, 30, 6x6, 44, 7x7, 4x5, 5x7

Preis/Prix
82.20

**FRIES «Clixrack 500»****«Typ K»**

Glashöhen bis 140 mm
Korb mit Toprahmen und zwei Facheinteilungen
Hauteur jusqu'à 140 mm
Casier avec cadre supérieur et deux séparations

Einteilung/Répartition
3x3, 4x4, 20, 5x5, 30, 6x6, 44, 7x7, 4x5, 5x7

Preis/Prix
93.85

**FRIES «Clixrack 500»****«Typ IH»**

Glashöhen bis 155 mm
Korb mit Toprahmen und zwei Facheinteilungen
Hauteur jusqu'à 155 mm
Casier avec cadre supérieur et deux séparations

Einteilung/Répartition
3x3, 4x4, 20, 5x5, 30, 6x6, 44, 7x7, 4x5, 5x7

Preis/Prix
93.85

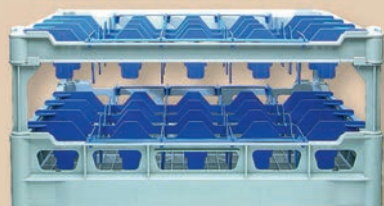
**FRIES «Clixrack 500»****«Typ KH»**

Glashöhen bis 170 mm
Korb mit Toprahmen und zwei Facheinteilungen
Hauteur jusqu'à 170 mm,
Casier avec cadre supérieur et deux séparations

Einteilung/Répartition
3x3, 4x4, 20, 5x5, 30, 6x6, 44, 7x7, 4x5, 5x7

Preis/Prix
93.85

SPÜLKÖRBE / CORBEILLES DE LAVAGE

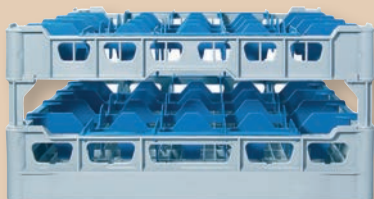

FRIES «Clixrack 500»

«Typ NH»

Glashöhen bis 185 mm
 Korb mit Toprahmen und zwei Facheinteilungen
Hauteur jusqu'à 185 mm
 Casier avec cadre supérieur et deux séparations

Einteilung/Répartition
 3x3, 4x4, 20, 5x5, 30, 6x6, 44, 7x7, 4x5, 5x7

Preis/Prix
93.85



FRIES «Clixrack 500»

«Typ MH»

Glashöhen bis 200 mm
 Korb mit Toprahmen und zwei Facheinteilungen
Hauteur jusqu'à 200 mm
 Casier avec cadre supérieur et deux séparations

Einteilung/Répartition
 3x3, 4x4, 20, 5x5, 30, 6x6, 44, 7x7, 4x5, 5x7

Preis/Prix
93.85



FRIES «Clixrack 500»

«Typ OH»

Glashöhen bis 215 mm
 Korb mit Toprahmen und zwei Facheinteilungen
Hauteur jusqu'à 215 mm
 Casier avec cadre supérieur et deux séparations

Einteilung/Répartition
 3x3, 4x4, 20, 5x5, 30, 6x6, 44, 7x7, 4x5, 5x7

Preis/Prix
93.85



FRIES «Clixrack 500»

«Typ LH»

Glashöhen bis 230 mm
 Korb mit Toprahmen und zwei Facheinteilungen
Hauteur jusqu'à 230 mm
 Casier avec cadre supérieur et deux séparations

Einteilung/Répartition
 3x3, 4x4, 20, 5x5, 30, 6x6, 44, 7x7, 4x5, 5x7

Preis/Prix
93.85

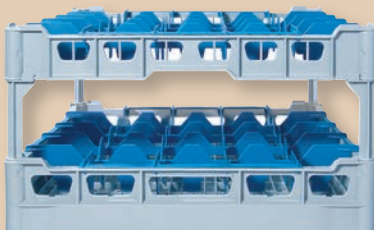

FRIES «Clixrack 500»

«Typ PH»

Glashöhen bis 245 mm
 Korb mit Toprahmen, Zwischenrahmen und zwei Facheinteilungen
Hauteur jusqu'à 245 mm
 Casier avec cadres supérieur et interne, deux séparations

Einteilung/Répartition
 3x3, 4x4, 20, 5x5, 30, 6x6, 44, 7x7, 4x5, 5x7

Preis/Prix
105.70



FRIES «Clixrack 500»

«Typ IKH3»

Glashöhen bis 260 mm
 Korb mit Toprahmen, Zwischenrahmen und drei Facheinteilungen
Hauteur jusqu'à 260 mm
 Casier avec cadres supérieur et interne, trois séparations

Einteilung/Répartition
 3x3, 4x4, 20, 5x5, 30, 6x6, 44, 7x7, 4x5, 5x7

Preis/Prix
141.10

SPÜLKÖRBE / CORBEILLES DE LAVAGE

CAMRACK®
Korb 1/2 Grösse
Casier grandeur 1/2

Standardfarbe wählbar, Toprahmenfarbe grau.
 Körbe der Grösse 1/2 eignen sich gut für die Aufbewahrung an Servicestationen.
 Sehr effektiv zum Tragen von weniger Gewicht und Aufbewahren in Räumlichkeiten mit Platzbegrenzung. Ideal für kleine Untertisch-Spülmaschinen.
Couleur standard au choix, couleur du cadre supérieur gris.
Les casiers de taille 1/2 sont adaptés au stockage dans des postes d'entretien
Très efficace pour le transport de poids légers et le stockage dans des espaces réduits. Idéal pour les petits lave-vaisselles encastrés.

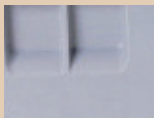
Basiskorbfarben
Couleur de casier de base

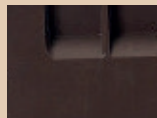
151
 Softgrau
 Gris tendre

119
 Flaschengrün
 Vert bouteille

167
 Braun
 Brun

184
 Beige
 Beige

186
 Marineblau
 Bleu marine

416
 Preiselbeere
 Canneberge

CAMRACK®
Basiskorb 1/2 Grösse mit 1 Extender
Casier de base grandeur 1/2 avec 1 extender

Art.-Nr./No d'article	Korbgrösse/dimension	Innenhöhe/hauteur int.	Preis/prix
8323.81xxx	500 x 254 x H 143 mm	124 mm	57.60

CAMRACK®
Basiskorb 1/2 Grösse mit 2 Extender
Casier de base grandeur 1/2 avec 2 extender

Art.-Nr./No d'article	Korbgrösse/dimension	Innenhöhe/hauteur int.	Preis/prix
8323.82xxx	500 x 254 x H 184 mm	165 mm	68.85

CAMRACK®
Basiskorb 1/2 Grösse mit 3 Extender
Casier de base grandeur 1/2 avec 3 extender

Art.-Nr./No d'article	Korbgrösse/dimension	Innenhöhe/hauteur int.	Preis/prix
8323.83xxx	500 x 254 x H 225 mm	206 mm	82.20

SPÜLKÖRBE / CORBEILLES DE LAVAGE



CAMRACK®
Gläserkorb, 1/2 Grösse
Casier à verres, grandeur 1/2

10 Fächer, Höchst-Durchmesser 87 mm
10 compartiments, diamètre maximum 87 mm

Art-Nr./No d'article	Korbgrösse/dimension	Maximale Höhe/hauteur max.	Preis/prix
8323.84xxx	500 x 254 mm	133 mm	74.05
8323.85xxx	500 x 254 mm	174 mm	93.85
8323.86xxx	500 x 254 mm	257 mm	132.90

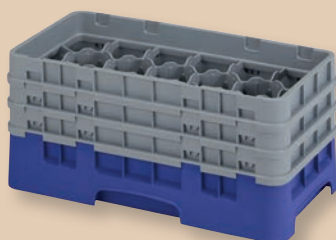

CAMRACK®
Gläserkorb, 1/2 Grösse
Casier à verres, grandeur 1/2

17 Fächer, Höchst-Durchmesser 73 mm
17 compartiments, diamètre maximum 73 mm

Art-Nr./No d'article	Korbgrösse/dimension	Maximale Höhe/hauteur max.	Preis/prix
8323.87xxx	500 x 254 mm	92 mm	55.25
8323.88xxx	500 x 254 mm	133 mm	76.45
8323.89xxx	500 x 254 mm	174 mm	99.90

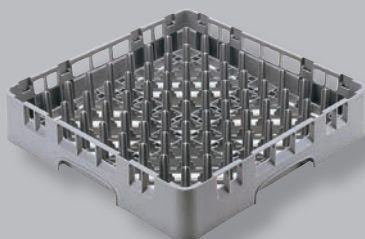

CAMRACK®
Dorn-Spülkorb
Casier de lavage à plats

BEST SELLER

Farbe grau. Für Teller, Schüsseln, Tablett und Tellerdeckel.
 Mit extra hohen Dornen für eine besonders gute Stabilität.
 Couleur gris. Pour assiettes, bols, plateau et cloches. Avec des plots spécialement élevés pour une très bonne stabilité.



CAMRACK®
Tellerkorb, Hochdorn für besonders gute Stabilität
Casier à assiettes, plots élevés pour une très bonne stabilité

Dornkorb mit 9 x 9 Reihen ideal für Standardteller
 Casier à plots avec 9 x 9 rangées idéal pour les assiettes standard

Art-Nr./No d'article	Korbgrösse/dimension	Innenhöhe/hauteur int.	Preis/prix
8323.80195	500 x 500 mm	83 mm	68.85



CAMRACK®
Tellerkorb, Hochdorn für besonders gute Stabilität
Casier à assiettes, plots élevés pour une très bonne stabilité

Dornkorb mit 5 x 9 Reihen hält Standardteller in einer Richtung und tiefe Teller, Schüsseln und Tellerdeckel in die andere Richtung.
 Casier à plots avec 5 x 9 rangées qui maintient les assiettes standard dans une direction et les assiettes creuses, les bols et les cloches dans une autre direction.

Art-Nr./No d'article	Korbgrösse/dimension	Innenhöhe/hauteur int.	Preis/prix
8323.80200	500 x 500 mm	83 mm	68.85

SPÜLKÖRBE / CORBEILLES DE LAVAGE

**FRIES «Basys 500»
Grundkorb
Casier de base**

Innenhöhe 150 mm
Hauteur intérieure 150 mm

Art-Nr./No d'article Korbgröße/dimension
8295.05001 500 x 500 mm

Preis/prix
57.60

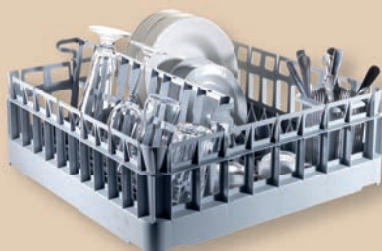
**FRIES «Basys 500»
Kombikorb
Casier combi**

Bestehend aus 1 x Grundkorb 500 mm, 1 x Glasrelax 500 mm,
1 x Tellereinsatz 400 mm, 1 x Besteckköcher
Composé d'un panier de base de 500 mm, 1 x insert pour verres 500 mm,
1 x insert pour assiettes 400 mm, 1 x godet à couverts de table.

Art-Nr./No d'article Korbgröße/dimension
8295.05002 500 x 500 mm

Preis/prix
76.45

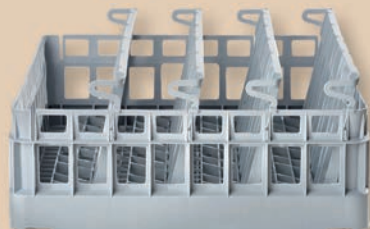
**FRIES «Basys 500»
Gläserkorb
Casier à verres**

Bestehend aus 1 x Grundkorb 500 mm, 4 x Glasrelax 500 mm
Composé d'un panier de base de 500 mm, 4 x inserts pour verres 500 mm

Art-Nr./No d'article Korbgröße/dimension
8295.05003 500 x 500 mm

Preis/prix
93.85

**FRIES «Basys 500»
Glaseinsatz «Glasrelax»
Insert pour verres «Glasrelax»**

zur Schrägstellung der Gläser
pour position des verres en biais

Art-Nr./No d'article Korbgröße/dimension
8295.05004 500 x 500 mm

Preis/prix
8.20

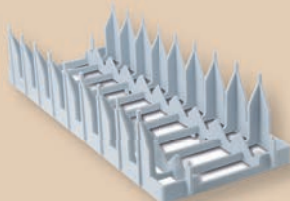
**FRIES «Basys 500»
Tellereinsatz
Insert pour assiettes**

zum Spülen von 9 Tellern bis ca. Ø 24 cm, Tellereinsatz ist herausnehmbar
pour laver 9 assiettes jusqu'à env. Ø 24 cm, insert amovible

Art-Nr./No d'article Korbgröße/dimension
8295.05005 400 x 400 / 500 x 500 mm

Preis/prix
7.60

**FRIES «Basys 500»
Besteckköcher
Godet à couverts de table**

pyramidenförmiger Becher zur besseren Auffächerung des Bestecks
Panier forme pyramidale pour une meilleure répartition des couverts

Art-Nr./No d'article
655118300

Preis/prix
3.50

SPÜLKÖRBE / CORBEILLES DE LAVAGE

FRIES «Rack System 400»
Gläserkörbe für gerade stehende Gläser
Casiers à verres pour verres en position verticale
400 x 400 mm

Korbfarbe grau, die Körbe haben eine Einschubbreite von 396 mm und sind palettisierbar. Auf Anfrage auch mit Einschubbreite 390 mm erhältlich.
 Paniers de couleur grise, largeur d'insertion de 396mm, ils conviennent aux palettes.
 Egalement disponible sur demande avec une largeur d'insertion de 390 mm.

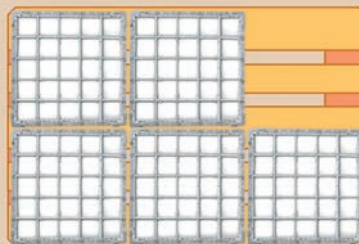

**[Palletisierbar
 Convient pour palette]**

Facheinteilungen
Répartition des cases



3 x 3 **4 x 4** **5 x 5** **3 x 4** **4 x 5**
 Ø max 115 mm Ø max 88 mm Ø max 68 mm 115 x 88 mm 88 x 68 mm

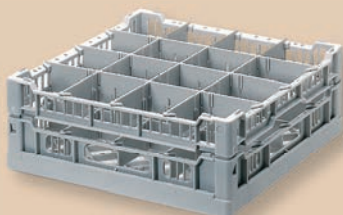

FRIES «Rack System 400»

«Typ LB»

Glashöhen: 120, 132, 144, 156, 168, 180 mm / Einschubbreiten 390 + 396 mm
 Korb mit einer Facheinteilung
 Hauteur jusqu'à 120, 132, 144, 156, 168, 180 mm / Largeur 390 + 396 mm
 Casier avec une séparation

Einteilung/Répartition
 3x3, 4x4, 5x5, 3x4, 4x5

Preis/Prix
79.95

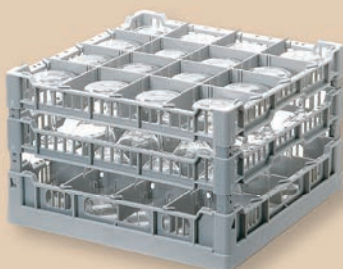

FRIES «Rack System 400»

«Typ LC»

Glashöhen: 192, 204, 216, 228, 240 mm / Einschubbreiten 390 + 396 mm
 Korb mit Toprahmen, Zwischenrahmen und zwei Facheinteilungen
 Hauteur jusqu'à 192, 204, 216, 228, 240 mm / Largeur 390 + 396 mm
 Casier avec cadre supérieur, cadre interne et deux séparations

Einteilung/Répartition
 3x3, 4x4, 5x5, 3x4, 4x5

Preis/Prix
93.85

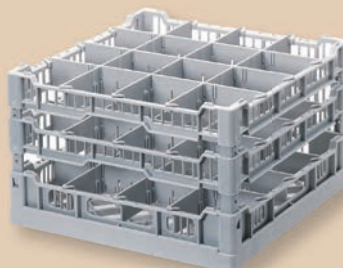

FRIES «Rack System 400»

«Typ LD3»

Glashöhen: 240, 252, 264 mm / Einschubbreiten 390 + 396 mm
 Korb mit Toprahmen, Zwischenrahmen und drei Facheinteilungen
 Hauteur jusqu'à 240, 252, 264 mm / Largeur 390 + 396 mm
 Casier avec cadre supérieur, cadre interne et trois séparations

Einteilung/Répartition
 3x3, 4x4, 5x5, 3x4, 4x5

Preis/Prix
105.60

CATERING TRANSPORTBOXEN / BOX DE TRANSPORT POUR CATERING



Separationen für Mineralwasser-Gläser Séparations pour verres à l'eau minérale

Separationshöhe: 125 mm, Separationsdicke: 2 mm
Hauteur de la séparation: 125 mm, épaisseur: 2 mm

Art-Nr./No d'article	Fachgröße/Mesure casiers	Fächer/casiers	Glashöhe/hauteur int.	Preis/prix
8121.00000	64 x 64 mm	40	95 – 125 mm	141.10

Preis inklusive Eurobehälter RAKO 60 x 40 cm
Prix inclus box RAKO 60 x 40 cm



Separationen für Weisswein-Gläser Séparations pour verres à vin blanc

Separationshöhe: 140 mm, Separationsdicke: 2 mm
Hauteur de la séparation: 140 mm, épaisseur: 2 mm

Art-Nr./No d'article	Fachgröße/Mesure casiers	Fächer/casiers	Glashöhe/hauteur int.	Preis/prix
8121.00001	73 x 73 mm	28	110 – 140 mm	99.90

Preis inklusive Eurobehälter RAKO 60 x 40 cm
Prix inclus box RAKO 60 x 40 cm



Separationen für Rotwein-Gläser Séparations pour verres à vin rouge

Separationshöhe: 158 mm, Separationsdicke: 2 mm
Hauteur de la séparation: 158 mm, épaisseur: 2 mm

Art-Nr./No d'article	Fachgröße/Mesure casiers	Fächer/casiers	Glashöhe/hauteur int.	Preis/prix
8121.00002	78 x 78 mm	28	125 – 158 mm	116.40

Preis inklusive Eurobehälter RAKO 60 x 40 cm
Prix inclus box RAKO 60 x 40 cm



Separationen für Sekt-Gläser
Séparations pour verres à vins mousseaux

Separationshöhe: 185 mm, Separationsdicke: 2 mm
Hauteur de la séparation: 185 mm, épaisseur: 2 mm

Art-Nr./No d'article	Fachgrösse/Mesure casiers	Fächer/casiers	Glashöhe/hauteur int.	Preis/prix
8121.00003	70 x 70 mm	35	150 – 180 mm	132.90

Preis inklusive Eurobehälter RAKO 60 x 40 cm
Prix inclus box RAKO 60 x 40 cm



Separationen für Bierstangen/Rotwein-Gläser
Séparations pour verres à bière/vin rouge

Separationshöhe: 185 mm, Separationsdicke: 2 mm
Hauteur de la séparation: 185 mm, épaisseur: 2 mm

Art-Nr./No d'article	Fachgrösse/Mesure casiers	Fächer/casiers	Glashöhe/hauteur int.	Preis/prix
8121.00004	82 x 82 mm	24	155 – 185 mm	132.90

Preis inklusive Eurobehälter RAKO 60 x 40 cm
Prix inclus box RAKO 60 x 40 cm



Separationen für Salatteller
Séparations pour assiettes à salade

Separationshöhe: 100 mm, Separationsdicke: 4 mm, Dreieckunterteilung
Hauteur de la séparation: 100 mm, épaisseur: 4 mm, séparation triangulaire

Art-Nr./No d'article	Ø Teller/Ø assiettes	Fächer/casiers	Anzahl Teller/nombre d'assiettes	Preis/prix
8121.00005	190 – 210 mm	3	3 x 8 = 24	84.65

Preis inklusive Eurobehälter RAKO 60 x 40 cm
Prix inclus box RAKO 60 x 40 cm



Separationen für Menüteller
Séparations pour assiette menu

Separationshöhe: 150 mm, Separationsdicke: 4 mm, Diagonalunterteilung
Hauteur de la séparation: 150 mm, épaisseur: 4 mm, séparation diagonale

Art-Nr./No d'article	Ø Teller/Ø assiettes	Fächer/casiers	Anzahl Teller/nombre d'assiettes	Preis/prix
8121.00006	240 mm	2	2 x 12 = 24	63.50

Preis inklusive Eurobehälter RAKO 60 x 40 cm
Prix inclus box RAKO 60 x 40 cm



Separationen für Menüteller
Séparations pour assiette menu

Separationshöhe: 150 mm, Separationsdicke: 4 mm, Separation als Z-Unterteilung steil
Hauteur de la séparation: 150 mm, épaisseur: 4 mm, séparation en «Z», raide

Art-Nr./No d'article	Ø Teller/Ø assiettes	Fächer/casiers	Anzahl Teller/nombre d'assiettes	Preis/prix
8121.00008	260 – 280 mm	2	2 x 10 = 20	93.85

Preis inklusive Eurobehälter RAKO 60 x 40 cm
Prix inclus box RAKO 60 x 40 cm

CATERING TRANSPORTBOXEN / BOX DE TRANSPORT POUR CATERING

Separationen für Platzteller
Séparations pour assiette de présentation

Separationshöhe: 150 mm, Separationsdicke: 4 mm, 2 Separationsteile pro Behälter

Hauteur de la séparation: 150 mm, épaisseur: 4 mm, 2 séparations par box

Art-Nr./No d'article	Ø Teller/Ø assiettes	Fächer/casiers	Anzahl Teller/nombre d'assiettes	Preis/prix
8121.00009	300 – 320 mm	1	1 x 10 = 10	89.35

Preis inklusive Eurobehälter RAKO 60 x 40 cm
 Prix inclus box RAKO 60 x 40 cm

Separationen für Unterteller/Aschenbecher/Suppentassen
Séparations pour soucoupes/cendriers/tasses à potage

Separationshöhe: 95 mm, Separationsdicke: 2 mm

Hauteur de la séparation: 95 mm, épaisseur: 2 mm

Art-Nr./No d'article	Ø Teller/Ø assiettes	Fächer/casiers	Anzahl Teller/nombre d'assiettes	Preis/prix
8121.00010	110 – 130 mm	8	8 x 10 = 80	89.35

Preis inklusive Eurobehälter RAKO 60 x 40 cm
 Prix inclus box RAKO 60 x 40 cm

Separationen für Unterteller/Aschenbecher/Suppentassen
Séparations pour soucoupes/cendriers/tasses à potage

Separationshöhe: 95 mm, Separationsdicke: 2 mm

Hauteur de la séparation: 95 mm, épaisseur: 2 mm

Art-Nr./No d'article	Ø Teller/Ø assiettes	Fächer/casiers	Anzahl Teller/nombre d'assiettes	Preis/prix
8121.00011	140 – 160 mm	6	6 x 10 = 60	70.45

Preis inklusive Eurobehälter RAKO 60 x 40 cm
 Prix inclus box RAKO 60 x 40 cm

Separationen für Espressotassen/Tee-Gläser
Séparations pour Tasses à espresso/verre à thé

Separationshöhe: 45 mm, Separationsdicke: 2 mm

Hauteur de la séparation: 45 mm, épaisseur: 2 mm

Art-Nr./No d'article	Fächergröße/casiers	Fächer/casiers	Preis/prix
8121.00012	83 x 63 mm	30	70.45

Preis inklusive Eurobehälter RAKO 60 x 40 cm
 Prix inclus box RAKO 60 x 40 cm

Separationen für Kaffeetassen/Tee-Tassen/Boccalino
Séparations pour Tasses à café/thé/boccalino

Separationshöhe: 45 mm, Separationsdicke: 2 mm

Hauteur de la séparation: 45 mm, épaisseur: 2 mm

Art-Nr./No d'article	Fächergröße/casiers	Fächer/casiers	Preis/prix
8121.00013	100 x 83 mm	20	68.20

Preis inklusive Eurobehälter RAKO 60 x 40 cm
 Prix inclus box RAKO 60 x 40 cm

CATERING TRANSPORTBOXEN / BOX DE TRANSPORT POUR CATERING



Glas Manager Set
Set de manager de verre

Für 33 Gläser > Ø 67 mm
Pour 33 verres > Ø 67 mm

Art-Nr./No d'article	Glashöhe/hauteur int.	passend zu/pour	Preis/prix
8121.00101	80 – 130 mm	RAKO 3-208Z-O	89.35
8121.00102	131 – 180 mm	RAKO 3-201Z-O	89.35
8121.00103	181 – 230 mm	RAKO 3-6426N-O	89.35
8121.00104	231 – 280 mm	RAKO 3-202Z-O	89.35

Einzelteile/Pièces détachées

Art-Nr./No d'article	Artikel/Article	Höhe/hauteur	Stapelhöhe/hauteur	Preis/prix
8121.00105	Unterteil/Pièce inférieure	72 mm	65 mm	38.80
8121.00106	Oberteil/Pièce supérieure			38.80

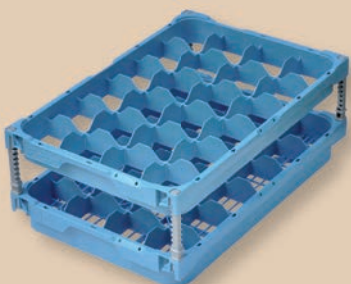

Glas Manager Set
Set de manager de verre

Für 24 Gläser, Ø 68-80 mm
Pour 24 verres, Ø 68-80 cm

Art-Nr./No d'article	Glashöhe/hauteur int.	passend zu/pour	Preis/prix
8121.00201	80 – 130 mm	RAKO 3-208Z-O	89.35
8121.00202	131 – 180 mm	RAKO 3-201Z-O	89.35
8121.00203	181 – 230 mm	RAKO 3-6426N-O	89.35
8121.00204	231 – 280 mm	RAKO 3-202Z-O	89.35

Einzelteile/Pièces détachées

Art-Nr./No d'article	Artikel/Article	Höhe/hauteur	Stapelhöhe/hauteur	Preis/prix
8121.00205	Unterteil/Pièce inférieure	72 mm	65 mm	38.80
8121.00206	Oberteil/Pièce supérieure			38.80



Glas Manager Set
Set de manager de verre

Für 15 Gläser, Ø 81-95 mm
Pour 15 verres, Ø 81-95 mm

Art-Nr./No d'article	Glashöhe/hauteur int.	passend zu/pour	Preis/prix
8121.00301	80 – 130 mm	RAKO 3-208Z-O	89.35
8121.00302	131 – 180 mm	RAKO 3-201Z-O	89.35
8121.00303	181 – 230 mm	RAKO 3-6426N-O	89.35
8121.00304	231 – 280 mm	RAKO 3-202Z-O	89.35

Einzelteile/Pièces détachées

Art-Nr./No d'article	Artikel/Article	Höhe/hauteur	Stapelhöhe/hauteur	Preis/prix
8121.00305	Unterteil/Pièce inférieure	72 mm	65 mm	38.80
8121.00306	Oberteil/Pièce supérieure			38.80

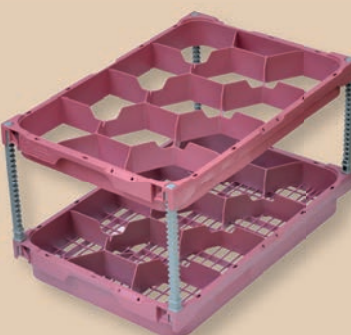

Glas Manager Set
Set de manager de verre

Für 11 Gläser, Ø 96-120 mm
Pour 11 verres, Ø 96-120 mm

Art-Nr./No d'article	Glashöhe/hauteur int.	passend zu/pour	Preis/prix
8121.00401	80 – 130 mm	RAKO 3-208Z-O	89.35
8121.00402	131 – 180 mm	RAKO 3-201Z-O	89.35
8121.00403	181 – 230 mm	RAKO 3-6426N-O	89.35
8121.00404	231 – 280 mm	RAKO 3-202Z-O	89.35

Einzelteile/Pièces détachées

Art-Nr./No d'article	Artikel/Article	Höhe/hauteur	Stapelhöhe/hauteur	Preis/prix
8121.00405	Unterteil/Pièce inférieure	72 mm	65 mm	38.80
8121.00406	Oberteil/Pièce supérieure			38.80

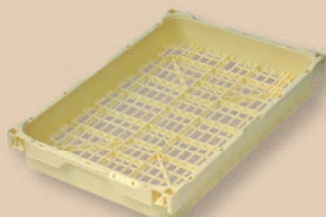

Glas Manager Unterteil ohne Separationen
Pièce inférieure sans séparations du manager de verre

Art-Nr./No d'article	Artikel/Article	Höhe/hauteur	Stapelhöhe/hauteur	Preis/prix
8121.00410	Unterteil/Pièce inférieure	72 mm	65 mm	38.80

CATERING TRANSPORTBOXEN / BOX DE TRANSPORT POUR CATERING

**Säulen-Set für Glas Manager****Set piliers pour set de manager de verre**

Set à 4 Säulen, passend zu allen Glas Manager Typen

Set à 4 piliers, conviennent à tous les types du manager de verres

Art-Nr./No d'article	Glashöhe/hauteur int.
8121.00411	80 – 130 mm
8121.00412	131 – 180 mm
8121.00413	181 – 230 mm
8121.00414	231 – 280 mm

Preis/prix
11.70
11.70
11.70
11.70

**Beschriftungs-Clips für Glas Manager****Clips de marquage pour manager de verres**

Set à 4 Clips, passend zu allen Glas Manager Typen

Set à 4 clips, conviennent pour tous les types du manager de verres

Art-Nr./No d'article	Farbe/couleur
8121.00421	rot/rouge
8121.00422	hellelfenbein/ivoire claire
8121.00423	gelb/jaune
8121.00424	blau/bleu

Preis/prix
5.25
5.25
5.25
5.25

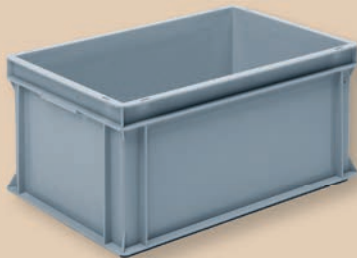
**Eurobehälter RAKO 600 x 400 mm****Bacs RAKO Euro-normes, 600 x 400 mm**

Seitenwände geschlossen, Boden geschlossen, 2 Muschelgriffe

Parois pleines, Fond plain, 2 poignées coquilles

Art-Nr./No d'article	Höhe/hauteur		Preis/prix
8121.00021	170 mm	RAKO 3-208Z-O	46.90
8121.00022	220 mm	RAKO 3-201Z-O	51.70
8121.00023	278 mm	RAKO 3-6426N-1	57.60
8121.00024	325 mm	RAKO 3-202Z-O	58.55

**Auflagedeckel zu Eurobehälter RAKO****Couvercle pour Eurobox RAKO**

Art-Nr./No d'article	Masse/Mesure	Farbe/couleur	Preis/prix
8121.00014	60 x 40 cm	Dunkelgrau/Gris-foncé	18.80

**Hakendeckel zu Eurobehälter RAKO****Couvercle de gerbage pour Eurobox RAKO**

Art-Nr./No d'article	Masse/Mesure	Farbe/couleur	Preis/prix
8121.00025	60 x 40 cm	Dunkelgrau/Gris-foncé	19.75

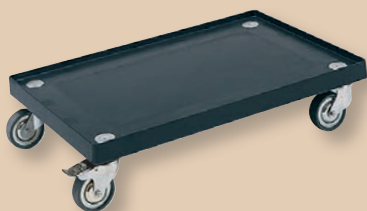

**Transportroller
Chariot pour box**

Aus Kunststoff, für Behälter 60 x 40 cm, 4 Lenkrollen Ø 75 mm, 1 Feststellbremse
Matière synthétique, pour box 60 x 40 cm, 4 roues directices Ø 75 mm, 1 roue avec frein

Art-Nr./No d'article	Aussenmasse/Mesure exterieur	Nutzlast/charge utile	Preis/prix
8121.00017	58,6 x 38,6 cm x H 13,5 cm	- 150 kg	132.90



**Transportroller
Chariot pour box**

Aus Metall, galvanisch verzinkt, für Behälter 60 x 40 cm, 4 Lenkrollen Ø 75 mm, 1 Feststellbremse
Zinc galvanisé, pour box 60 x 40 cm, 4 roues directices Ø 75 mm, 1 roue avec frein

Art-Nr./No d'article	Aussenmasse/Mesure exterieur	Nutzlast/charge utile	Preis/prix
8121.00018	58,2 x 38 cm x H 12 cm	- 150 kg	164.45



**Transportroller mit Lenkbügel
Chariot pour box avec poignée de guidage**

Aus Metall, galvanisch verzinkt, für Behälter 60 x 40 cm, 4 Lenkrollen Ø 75 mm
Métallique, zinc galvanisé, pour box 60 x 40 cm, 4 roues directices Ø 75 mm

Art-Nr./No d'article	Aussenmasse/Mesure exterieur	Nutzlast/charge utile	Preis/prix
8121.00020	58 x 38 cm x H 88 cm	- 150 kg	398.85

CATERING TRANSPORTBOXEN / BOX DE TRANSPORT POUR CATERING



**BEST
SELLER**

FRIES
Geschirrtransportbox
Box de transport de vaisselle

Box ohne Deckel, passend auf Euro-Paletten, verwindungssteif und robust, stapelbar, aus lebensmittelechtem transparentem PP

Box sans couvercle, Format EURO palette, résistant à la déformation, robuste, empilable, en polypropylène transparent spécial produits alimentaires

Art-Nr./No d'article	Aussenmasse/dimension ext.	Innenmasse/dimension int.	Preis/prix
8295.00009	40 x 40 cm x H 31,5 cm	32,5 x 32,5cm x H 27 cm	28.20

FRIES
Deckel zu Geschirrtransportbox
Couvercle pour box de transport de vaisselle

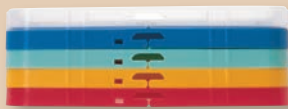

Art-Nr./No d'article	Farbe/couleur	Preis/prix
8295.00010	transparent/transparent	10.55
8295.00011	blau/bleu	10.55
8295.00012	grün/vert	10.55
8295.00013	gelb/jaune	10.55
8295.00014	rot/rouge	10.55



FRIES
Fixierrohr für Box
Tube de fixation pour box

Art-Nr./No d'article	Preis/prix
8295.00015	5.60



FRIES
Bodenplatte für Box
Plaque de fond pour box

Art-Nr./No d'article	Preis/prix
8295.00016	3.50

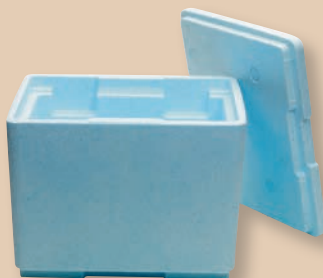

FRIES
Thermoeinsatz für Box
Insert thermique pour box

in den Thermoeinsatz passen 1 Schale GN 1/2 oder 2 Schalen GN 1/4
convient pour 1 bac GN 1/2 ou 2 bacs GN 1/4

Art-Nr./No d'article	Preis/prix
8295.00025	50.55

REINIGUNG / NETTOYAGE



Geschirrtücher und Mikrofaser-Tücher finden Sie im Kapitel Textilien.

Essuies-vaisselles et chiffons en microfibre vous trouvez au chapitre «textiles».



Unratzange Pince refusant

Rohrstiel schwarz lackiert, Greifer verzinkt mit Kunststoff-Ummantelung, automatische Rückfederung, Gewicht: 500 g
Tuyau de pipe peinte en noir, crochet galvanisé avec revêtement plastique, résilience automatique, poids: 500 g

Art-Nr./No d'article Grösse/grandeur
8990.00100 105 cm

Preis/prix
46.90



Kehrschaufelset Set de pelle

Ergonomisch gestaltet: abgewinkelter Tragegriff in 74 cm Hüfthöhe, angenehme Tragehöhe, stabile Ausführung aus grauem Polypropylen und Alurahmen, verstellbarer schmalbürstiger Besen für schwer zugängliche Stellen, Teleskopstange bis 100 cm aus Aluminium mit Aufhängehaken

Conception ergonomique: poignée coudée à 74 cm hauteur de taille, hauteur de la charge confortable, conception solide en polypropylène gris et cadre en aluminium, balai réglable avec brosse mince pour endroits difficiles à atteindre, tige télescopique à 100 cm en aluminium avec suspension

Art-Nr./No d'article Grösse/grandeur
8990.00200 20 x 30 x 10 cm

Preis/prix
76.45



Tisch-Krömelbürste
Ramasse-miettes roulant

Inox, hochglänzend, mit lackiertem Holzgriff
Inox, poli brillant, manche en bois verni

Art-Nr./No d'article
8005.35151

Preis/prix
51.70

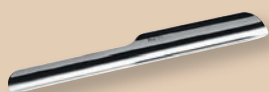

Tischkrümelsammler
Ramasse-miettes

Inox 18/10
Inox 18/10

Art-Nr./No d'article Grösse/grandeur
8005.35105 16,3 cm

Preis/prix
3.75



Tischkrümelentferner
Ramasse-miettes

Inox, hochglänzend, gewölbt, mit Metall-Clip
Inox, poli brillant, lombé, avec clip métal

Art-Nr./No d'article Grösse/grandeur
8005.35150 15 x 1,5 cm

Preis/prix
2.95



Mehlbürste
Brosse à farine

schwarze Borsten
soies noires

Art-Nr./No d'article Grösse/grandeur
8006.90100 L 21 cm

Preis/prix
27.75



Standascherpinsel
Pinceau de cendrier bise

Mit Befestigungsloch
Avec trou de fixation

Art-Nr./No d'article Grösse/grandeur
8005.35400 24 cm

Preis/prix
6.10



**PEUGEOT «Bilbo»
Karaffenreinigungskugeln
Billes de nettoyage pour carafes**

Karaffenreinigungskugeln in Kunststoffbehälter
Fioles billes nettoyantes pour carafes

Art-Nr./No d'article Grösse/grandeur
8020.00000 H: 11,5 cm / Ø max. ca 6 cm

Preis/prix
19.50



**Flaschenbürste
Goupillon**

Nylon, Polyamid-Griff
Nylon, manche en polyamide

Art-Nr./No d'article Grösse/grandeur
8006.50930 42 x Ø 6 cm

Preis/prix
10.55



**SCHOTT
Reinigungsbürste
Brosse de nettoyage**
für Glas-Trinkhalme
pour pailles en verre

Art-Nr./No d'article Grösse/grandeur
8003.50005 31,5 cm

Preis/prix
4.90



**Grillbürste
Brosse en fil d'acier**

mit fünf Reihen Stahldrahtborsten, nicht rostfrei, auf massivem Holzgriff
avec cinq rangées de poils en fil d'acier, non antirouille, sur un manche en bois massif

Art-Nr./No d'article Grösse/grandeur
8006.48100 30 x 3,5 cm

Preis/prix
6.10



**Stielschaber
Racloir à bâtons**

ummanteltes 18 mm Stahlrohr mit schwarzem Kunststoffgriff, Klingenthalerung aus Zinkguss, Klinge aus geschärftem Karbonstahl
Tube en acier gainé de 18 mm avec manche en plastique noir, porte-lame en fonte de zinc, lame en acier au carbone aiguisé

Art-Nr./No d'article Grösse/grandeur
8006.48110 15 x 46 cm

Preis/prix
19.40

Ersatzteile/Pièces de rechange

8006.48111 Ersatzklingen 5 Stück
Lame de rechange, 5 pièces

8.20



**«Béargent»
Pulver für Silber-Desoxydierungsbad
Poudre pour bain de désoxydation de l'argenterie**

Dosierung: 100 g pro 25 Liter Wasser.
Dosage 100 g pour 25 litres d'eau.

Art-Nr./No d'article Inhalt/capacité
455040 5 kg

Preis/prix
78.80



**WMF «Purargan Forte»
Pflegemittel für Silber, Messing und Kupfer
Lotion nettoyage argenté**

Purargan forte reinigt und poliert, schützt Silberwaren nachhaltig vor dem Anlaufen. Stets strahlender Glanz durch WMF Purargan forte.
Purargan forte nettoie et polit, protège durablement les produits en argent contre le ternissement. Brillance toujours éclatante grâce à WMF Purargan forte.

Art-Nr./No d'article Inhalt/capacité
14.2831.9990 1 L

Preis/prix
23.50



**WMF «Purargan»
Silbertauchbad
Bain d'argent**

Purargan Silbertauchbad macht angelaufenes Silber in Sekunden hell und rein.
Le bain de trempage Purargan pour l'argent rend l'argent terni clair et pur en quelques secondes.

Art-Nr./No d'article Inhalt/capacité
14.2826.9990 5 L

Preis/prix
46.80



**Silbertauchreiniger, gebrauchsfertig
Produit de trempage pour l'argenterie, prêt à l'emploi**

Reinigt blitzschnell angelaufenes und verfärbtes Silber. Unverdünnt in einen Plastikbehälter geben und das Besteck einige Sekunden eintauchen. Größere Gegenstände mit getränktem Wattebausch behandeln. Sofort mit fließendem Wasser gründlich abspülen und nachtrocknen. Nicht für oxidierte Dekors, Chromstahl, Aluminium und versilbertes Porzellan geeignet.
Nettoie instantanément l'argent noirci. Verser le produit non dilué dans un récipient en plastique et y plonger l'argenterie quelques secondes. Frotter les objets de plus grande dimension avec un tampon d'ouate imbibé du produit. Rincer immédiatement et soigneusement à l'eau courante et essuyer. Ne convient pas aux objets décorés par oxydation, en acier chromé, en aluminium, ni en porcelaine argentée.

Art-Nr./No d'article Inhalt/capacité
455048 5,1 kg

Preis/prix
116.40



**«Etolit»
Porzellanreiniger
Produit de nettoyage pour porcelaine et inox**

Art-Nr./No d'article Inhalt/capacité
411363901 1 L

Preis/prix
16.50



**Reinigungstabs, 25 Stück
Tabs de débouillage, 25 pcs**

Zum zuverlässigen Entfernen von hartnäckigen Verkrustungen durch Kaffee und Tee in allen Isolierkannen mit Glaskolben und Edelstahlkannen. Verhindert nachhaltig die Bildung von Keimen und Bakterien. Alle 8 - 12 Wochen eine Grundierung.

pour éloigner des restes de café et de thé dans tous les pots isolants avec ballon et pots en acier inoxydable. Préviend durable la constitution de germes et bactéries. Toutes les 8-12 semaines une couche d'impression.

Art-Nr./No d'article
8275.00100

Preis/prix
23.50



**SPRING
Kupfer-Reiniger
Nettoyant pour cuivre**

Kupfer-Reiniger einfach und effizient in der Anwendung für Kupfer und Messing. Pour cuivre et laiton.

Art-Nr./No d'article Grösse/grandeur
8006.20315 250 g
8006.20316 750 g

Preis/prix
19.95
28.90



**PACOJET
Reinigungstabs
Comprimés pour nettoyage**

60 Tabs à 3 g
60 Tabs à 3 g

Art-Nr./No d'article
8270.41050

Preis/prix
Auf Anfrage
Sur demande



WESCO
Treteimer
Poubelle à pédale

Schlichter Treteimer mit 13 Liter Fassungsvermögen, praktischem Handgriff und integriertem Dämpfer für ein geräuscharmes Schliessen des Deckels. Hygienischer Kunststoffeinsatz.

Poubelle à pédale sobre d'une capacité de 13 litres, avec poignée pratique et amortisseur intégré pour une fermeture silencieuse du couvercle. Insert hygiénique en plastique.

Art-Nr./No d'article	Grösse/grandeur	Inhalt/capacité	Preis/prix
8009.00320	Ø 25 cm x H 40,5 cm	13 L	84.65



WESCO
Treteimer
Poubelle à pédale

Gastrotauglicher Abfallsammler mit herausnehmbarem Einsatz aus feuersicherem verzinkten Stahlblech.

Poubelle convenant au débarassement de déchets dans la restauration avecseau mobile intérieur galvanisé anti-feu.

Art-Nr./No d'article	Grösse/grandeur	Inhalt/capacité	Preis/prix
8009.00321	Ø 27 cm x H 58 cm	22 L	105.60
8009.00322	Ø 31 cm x H 57 cm	32 L	141.10



Abfallbehälter, Kunststoff
Conteneur, matière synthétique

Art-Nr./No d'article	Grösse/grandeur	Inhalt/capacité	Preis/prix
8121.00520	Ø 40 x H 46 cm	50 L	52.90

Zubehör/Accessoires		Preis/prix
8121.00521	Deckel/Couvercle Ø 43,8 cm	28.90



**Abfalleimer rund
Poubelle ronde**

aus weissem hochdichtem Polyethylen, temperaturbeständig von -30° C bis +60° C, mit zwei Griffen, in- und aufeinander stapelbar
En polyéthylène blanc, hermétique, résistant à la chaleur de -30° C à +60° C, avec 2 poignées, empilable et emboîtable.

Art-Nr./No d'article	Grösse/grandeur	Inhalt/capacité	Preis/prix
8006.42315	Ø 34,5 cm x H 41 cm	35 L	28.90
8006.42316	Ø 40,0 cm x H 47 cm	50 L	42.30
8006.42317	Ø 44,5 cm x H 57 cm	75 L	57.60
8006.42318	Ø 47,0 cm x H 67 cm	100 L	75.25

Zubehör/Accessoires

8006.42319	Deckel/Couvercle Ø 34,5 cm	15.25
8006.42320	Deckel/Couvercle Ø 40,0 cm	17.60
8006.42321	Deckel/Couvercle Ø 44,5 cm	21.15
8006.42322	Deckel/Couvercle Ø 47,0 cm	23.50



**«Brute®»
Abfalleimer
Conteneur**

rund, aus Polyethylen
rond, en Polyéthylène

Art-Nr./No d'article	Grösse/grandeur	Inhalt/capacité	Preis/prix
8009.00106	Ø 49,5 cm x H 58 cm	75,7 L	116.40

Zubehör/Accessoires

8009.00107	Deckel/Couvercle	30.55
8009.00108	Rollsockel/Socle roulant	188.10



**Abfallbehälter, Kunststoff
Conteneur, matière synthétique**

Art-Nr./No d'article	Grösse/grandeur	Inhalt/capacité	Preis/prix
0124162	Ø 42 x H 54 cm	50 L	93.85
0124172	Ø 52 x H 53,5 cm	75 L	116.40

Zubehör/Accessoires

0124202	Deckel/Couvercle 50 L / Ø 37 cm	30.55
0124212	Deckel/Couvercle 75 L / Ø 46 cm	44.55
0124232	Fahrgestell Edelstahl/Socle roulant inox 50 L / Ø 60 cm	258.55
0124132	Fahrgestell Edelstahl/Socle roulant inox 75 L / Ø 60 cm	258.55

REINIGUNG / NETTOYAGE

Tret-Beutelhalter
Poubelle à pédale

Mittige Öffnung per Fusspedal, Müheloses Einlegen und Entfernen der Müllsäcke, geeignet für Müllbeutel bis 120 ltr., 110 x 70 cm
 Ouverture type porte-feuilles actionnée par pédale, mise en place et retrait des sacs très facile, apte pour sacs de 120 l., dim. Sans sac 110 x 70 cm

Art-Nr./No d'article	Grösse/grandeur	Inhalt/capacité	Preis/prix
8582.00580	59 x 43 x H 96 cm	120 L	223.40

Abfallsammler, Standmodell
Collecteur à déchets, modèle de sol

Extrem robust, standfest und langlebig
 Extrêmement robuste, solide et de longévité élevée

Art-Nr./No d'article	Grösse/grandeur	Inhalt/capacité	Preis/prix
8005.35101	36 cm x H 59 cm	60 L	152.70
8005.35102	36 cm x H 74 cm	110 L	199.70

Abfallsammler, fahrbar
Collecteur à déchets, modèle mobile

Extrem robust und langlebig, mobil und transportfähig durch leichtgängige, breite Profilräder.
 Extrêmement robuste et de longévité élevée, mobile et pratique lors du transport grâce aux grandes roues à profils.

Art-Nr./No d'article	Grösse/grandeur	Inhalt/capacité	Preis/prix
8005.35103	45 cm x H 80 cm	110 L	258.55



**Pedaleimer
Seaux de poubelle avec pédale**

Aus Polyethylen (HDPE), mit Pedal zum vollständigen Öffnen des Deckels, grosse Räder aus Gummi erleichtern den Transport
Fabrique de polyéthylène (HDPE), avec pédale pour l'ouvrage complet du couvercle, grandes roues en élastique facilite le transport.

Art-Nr./No d'article	Grösse/grandeur	Inhalt/capacité	Preis/prix
8310.00910	42,5 x 50,0 x H 65,0 cm	80 L	223.40
8310.00920	48,0 x 53,0 x H 80,0 cm	100 L	270.35
8310.00930	55,0 x 46,0 x H 94,0 cm	120 L	317.40



**Pedaleimer
Poubelle à pédale**

grau, mit grauem Deckel, feuersicher
gris, avec couvercle gris, ignifugée

Art-Nr./No d'article	Grösse/grandeur	Inhalt/capacité	Preis/prix
8009.00100	46 x 32 cm x H 80 cm	70 L	351.50



**Tretabfalleiner industriell
Seaux de poubelle avec pédale industrielle**

Feuerfester Abfalleimer mit stabilen Beutelhalter. Gehäuse aus Weiss lackiertem Stahlblech. Erfüllt alle HACCP-Richtlinien und eignet sich daher zum professionellen Gebrauch in Industrie und Gewerbe. Die Bedienung des Deckels erfolgt per Fusspedal. Ein Gasdämpfer sorgt zudem dafür, dass der Deckel sicher und gedämpft schliesst.

Poubelle ignifuge avec support de sac stable. Corps en tôle d'acier laquée blanc. Conforme à toutes les directives HACCP et convient donc à un usage professionnel dans l'industrie et l'artisanat. La commande du couvercle se fait par pédale. Un amortisseur à gaz assure en outre une fermeture sûre et amortie du couvercle.

Art-Nr./No d'article	Grösse/grandeur	Inhalt/capacité	Preis/prix
M2000	37 x 37 x H 59 cm	45 L	423.30
M2001	44 x 44 x H 77 cm	90 L	635.05
M2002	53,5 x 53,5 x H 78 cm	152 L	976.25



Wäschsammler Collecteur de linge

Gestell Stahl pulverbeschichtet, zusammenklappbar, inkl. Wäschetasche
Etagère en acier poudré, escamotable, avec sac à linge

Art-Nr./No d'article	Grösse/grandeur	Preis/prix
8392.00045	50 x 50 x H 65 cm	317.40

Ersatzteile/Pièces de rechange		
8392.00046	Wäschetasche/Sac à linge	116.40



CADDIE «Caddie X» Wäschsammler Collecteur de linge

CADDIE X hat sich beim Etagenservice schon vielfach bewährt. Er fasst circa 150 Liter Wechselwäsche und lässt sich komplett zusammenklappen.

Stahlrohr, pulverbeschichtet in RAL 9006 (grau), Stabile untere Ablage, ebenfalls zusammenklappbar, Inkl. grauem Polyestersack 150 L, 4 Lenkrollen Ø125 mm mit Abweisingen, davon 2 Bremsrollen

CADDIE X a déjà fait ses preuves dans le service à l'étage. Il peut contenir environ 150 litres de linge de rechange et se replie complètement.

Tube d'acier, revêtement par poudre RAL 9006 (gris), Plateau inférieur stable, également pliable, Sac en polyester gris 150 L inclus, 4 roues pivotantes Ø125 mm avec anneaux défecteurs, dont 2 avec frein

Art-Nr./No d'article	Grösse/grandeur	Preis/prix
8490.00106	50 x 48,5 x H 105 cm	704.45

Ersatzteile/Pièces de rechange		
8490.00107	Wäschetasche/Sac à linge 150 L	72.20



CADDIE «Trisac» Wäschsammler Collecteur de linge

Vierkant-Stahlrohr, pulverbeschichtet in RAL 9006 (grau), Stabile untere Ablage aus Metallstreben, inkl. 2 Baumwollsäcke à 87 L, 4 Lenkrollen Ø100 mm mit Abweisingen

Structure solide et légère en tubes d'acier peint gris clair RAL9006, cadre support inférieur avec traverses métalliques anti-affaissement, 2 Sacs 87 L polyester inclus, 4 roulettes pivotantes Ø100 mm avec pare-chocs annulaires

Art-Nr./No d'article	Grösse/grandeur	Preis/prix
8490.00105	82 x 56 x H 104 cm	670.35

Ersatzteile/Pièces de rechange		
8490.00120	Wäschetasche/Sac à linge 80 L	62.30



CADDIE «TRISAC ALU 1»
Wäschesammler
Collecteur de linge

ABS-Bodenplatte weiss lackiert, inkl. 1 abnehmbaren Polyestersack grau, leichte Fixierung des Sackes durch Klemmbügel, farbiger Kunststoffdeckel

Base blanche en ABS, 1 sac polyester anthracite, mise en place de sac grâce à la fixation par anneau extérieur, couvercle en plastique teinté

Art-Nr./No d'article	Grösse/grandeur		Preis/prix
8490.00121	39 x 41 x H 88 cm	87 L	576.20

Andere Deckelfarbe auf Anfrage.
Autre couleur de couvercle sur demande.



CADDIE «TRISAC ALU 2»
Wäschesammler
Collecteur de linge

ABS-Bodenplatte weiss lackiert, inkl. 2 abnehmbaren Polyestersäcken grau, Leichte Fixierung de Säcke durch Klemmbügel, Farbige Kunststoffdeckel
Base blanche en ABS, 2 sacs polyester anthracite, mise en place des sacs grâce à la fixation par anneau extérieur, couvercle en plastique teinté pour chaque sac

Art-Nr./No d'article	Grösse/grandeur		Preis/prix
8490.00122	79 x 41 x H 88 cm	2 x 87 L	929.15

Andere Deckelfarbe auf Anfrage.
Autre couleur de couvercle sur demande.



CADDIE «TRISAC ALU 3»
Wäschesammler
Collecteur de linge

ABS-Bodenplatte weiss lackiert, inkl. 3 abnehmbaren Polyestersäcken grau, Leichte Fixierung de Säcke durch Klemmbügel, Farbige Kunststoffdeckel
Base blanche en ABS, 3 sacs polyester anthracite, mise en place des sacs grâce à la fixation par anneau extérieur, couvercle en plastique teinté pour chaque sac

Art-Nr./No d'article	Grösse/grandeur		Preis/prix
8490.00123	119 x 41 x H 88 cm	3 x 87 L	1317.45

Andere Deckelfarbe auf Anfrage.
Autre couleur de couvercle sur demande.

REINIGUNG / NETTOYAGE

**CADDIE «SAC Easy»
Wäschesammler
Collecteur de linge**

Die schmale und gleichzeitig stabile Bauweise machen die SAC-Modelle im täglichen Wäscheservice schnell unentbehrlich. Vierkant-Stahlrohr, pulverbeschichtet in RAL9006 (grau), stabile untere Ablage aus Metallstreben, Abnehmbarer Polyester-Wäschesack (195 L), 4 Lenkrollen Ø125 mm mit Abweisungen, davon 2 Bremsrollen

La gamme CADDIE SAC est de construction étroite afin de faciliter le passage dans les couloirs d'étage. Structure solide et légère en tube d'acier peint gris clair RAL9006, cadre support inférieur avec traverses métalliques anti-affaissement, sac en polyester 192 L démontable et lavable, 4 roulettes pivotantes Ø125 mm avec pare-chocs annulaire, dont 2 avec frein

Art.-Nr./No d'article	Grösse/grandeur		Preis/prix
8490.00065	103 x 56 x H 94 cm	■	623.25
8490.00070	103 x 56 x H 94 cm	■	623.25
8490.00075	103 x 56 x H 94 cm	■	623.25

Ersatzteile/Pièces de rechange

8490.00080	Wäschesack/Sac à linge 195 L	■	141.10
8490.00085	Wäschesack/Sac à linge 195 L	■	141.10
8490.00090	Wäschesack/Sac à linge 195 L	■	141.10

**CADDIE «Bactainer ALU S/L»
Transport- und Lagerbehälter mit Federboden
Collecteur de linge**

Eloxiertes Aluminium, Oberer Rand verstärkt, Wasserdichter Boden, Mobiler Federboden, der sich je nach Belastung senkt oder hebt für leichteres Be- und Entladen, 4 Schwerlastrollen Ø125 mm, Beladung mit max. 70 kg.

Aluminium anodisé, bord supérieur arrondi et renforcé rond étanche, fond mobile à niveaux constant monté sur ressort, 4 roulettes pour charges lourdes Ø 125 mm, charge maximale de 70 kg.

Art.-Nr./No d'article	Grösse/grandeur	Preis/prix
8490.00170	108 x 63 x H 80 cm / 336 L	2116.20

**«Ibiza»
Etagenwagen
Chariot de service**

Stabiler Stahlrohrrahmen, pulverbeschichtet in RAL 9006 (grau), Seitenverkleidungen und Rückwand aus unempfindlichen, stoss- und wasserfesten HPL-Platten, 2 Dekore zur Auswahl, 2 höhenverstellbare Einlegeböden, Nicht abfärbender rundum Gummistosschutz, nach oben klappbare Müllsackhalterung, nach oben klappbare Wäschesackhalterung inkl. Baumwollwäschesack 127 L, oberste Ebene mit Aufkantung als Abrutschschutz, 4 Lenkrollen Ø 150 mm

Structure légère et solide en tubes d'acier avec revêtement peinture gris clair RAL 9006, panneaux latéraux et arrière en HPL (imputrescible, inrayable et incassable), 2 finitions disponibles, 2 étagères ajustables, pare-chocs intégral non-marquant, support supérieur relevable pour sac poubelle, 2 pare-chocs annulaires d'angle, support supérieur relevable pour en polyester gris de 127 L (inclus), niveau supérieur avec rebord relevé, 4 roulettes pivotantes Ø150 mm

Art.-Nr./No d'article	Grösse/grandeur	Gewicht/poids	Preis/prix
8490.04002	133,5 x 56,6 x H 149,1 cm	31 kg	1763.30
8490.05002	153,5 x 56,6 x H 149,1 cm	38 kg	1881.05
8490.06002	175,5 x 56,6 x H 149,1 cm	46 kg	1998.55

Ersatzteile/Pièces de rechange

8490.00150	Wäschesack/Sac à linge 127 L		132.90
------------	------------------------------	--	--------

Zubehör/Accessoires

8490.00155	Kleinteilekasten für die Hotelkosmetik, H 10 cm Boîtes pour la cosmétique hôtelière, H 10 cm		164.45
------------	---	--	--------





**CADDIE «Trendie»
Servicetasche
Sac**

Faltbare Servicetasche: Eine kompakte, ergonomische und vielseitige Lösung für einen tadellosen, schnellen Service. Mit Aufsteckband zum Fixieren am HANDIE. Wasserdichtes PVC-Beschichtetes Polyester 600. Beladung mit max. 15 kg.
Sac Turn-Down compact pour un service polyvalent impeccable, rapide et ergonomique. Avec bande de fixation pour le HANDIE. PVC (imperméable recouvert en polyester 600). Chargement de 15 kg maximum.

Art-Nr./No d'article	Grösse/grandeur	Gewicht/poids	Preis/prix
8490.00180	45 x 38 x H 27 cm	2,9 kg	387.80



**CADDIE «Handie»
Zimmerservicetrolley
Trolley de ménage**

Anpassbarer Reinigungswagen. Die beiden Seitentaschen wurden zum Verstauen von Reinigungsmitteln und z.B. 1 Besen konzipiert und sind abwaschbar. Die Schubladen sind komplett herausnehmbar. Sie verfügen über ein Trennwandsystem auf Klettverschlussbasis, das abnehmbar sowie waschbar ist. Wasserdichtes PVC beschichtetes Polyester 600. Beladung mit max. 30 kg.

Chariot de nettoyage adaptable. Les deux poches latérales ont été conçues pour ranger les produits de nettoyage et 1 balai par exemple et sont lavables. Les tiroirs sont entièrement amovibles. Ils disposent d'un système de cloisons sur la base d'une fermeture velcro, qui est amovible ainsi que lavable. Polyester 600 enduit de PVC étanche. Chargement de 30 kg maximum.

Art-Nr./No d'article	Grösse/grandeur	Gewicht/poids	Preis/prix
8490.00185	45 x 38 x H 62 cm	8,8 kg	881.15



**CADDIE «Buddie»
Zimmerservicetrolley inkl. Servicetasche
Trolley de ménage avec sac**

Die Kombination aus den beiden separaten Elementen «Trendie» und «Handie» sorgt für ein unsichtbares und gleichzeitig effizientes Housekeeping. Anpassbarer Reinigungswagen. Die beiden Seitentaschen wurden zum Verstauen von Reinigungsmitteln und z.B. 1 Besen konzipiert und sind abwaschbar. Die Schubladen sind komplett herausnehmbar. Sie verfügen über ein Trennwandsystem auf Klettverschlussbasis, das abnehmbar sowie waschbar ist. Wasserdichtes PVC beschichtetes Polyester 600.

La combinaison de deux éléments séparés, «Trendie» et «Handie», assure un housekeeping à la fois invisible et efficace. Chariot de nettoyage adaptable. Les deux poches latérales ont été conçues pour ranger les produits de nettoyage et 1 balai par exemple et sont lavables. Les tiroirs sont entièrement amovibles. Ils disposent d'un système de cloisons sur la base d'une fermeture velcro, qui est amovible ainsi que lavable. Polyester 600 enduit de PVC étanche.

Art-Nr./No d'article	Grösse/grandeur	Gewicht/poids	Preis/prix
8490.00190	45 x 38 x H 89 cm	11,7 kg	1268.95

REINIGUNG / NETTOYAGE

Etagenwagen
Chariot de service

Gestell Stahl pulverbeschichtet, zusammenklappbar, Platten kunststoffbeschichtet mit Holzdekor, Gestell für Wäschesack und Abfallsammler sind anklappbar
Etagère en acier poudré, escamotable, plaques plastifiées, avec décor bois, emplacement pour sac à linge et poubelle.

Art-Nr./No d'article	Grösse/grandeur	Gewicht/poids	Preis/prix
8392.00050	130 x 54 x H 116 cm	34 kg	1324.25

Zubehör/Accessoires

8392.00051	Kleinteilekasten für die Hotelkosmetik <i>Boîtes pour la cosmétique hôtelière</i>	282.10
-------------------	--	---------------

Etagenwagen
Chariot de service

Gestell Stahl pulverbeschichtet, zusammenklappbar, Platten kunststoffbeschichtet mit Holzdekor, Gestell für Wäschesack und Abfallsammler sind anklappbar
Etagère en acier poudré, escamotable, plaques plastifiées, avec décor bois, emplacement pour sac à linge et poubelle.

Art-Nr./No d'article	Grösse/grandeur	Gewicht/poids	Preis/prix
8392.00060	170 x 54 x H 116 cm	42 kg	1763.30

Ersatzteile/Pièces de rechange

8392.00062	Wäschesack/Sac à linge	89.35
-------------------	------------------------	--------------

Zubehör/Accessoires

8392.00061	Kleinteilekasten für die Hotelkosmetik <i>Boîtes pour la cosmétique hôtelière</i>	388.00
-------------------	--	---------------

Service- und Minibarwagen
Chariot de service et minibar

Gestell silbergrau, Holz Buche, 4 Lenkrollen davon 2 mit Sperre
Etagère gris, équipement en bois d'hêtre, 4 roues dont 2 avec freins

Art-Nr./No d'article	Grösse/grandeur	Preis/prix
8392.00070	51 x 84,5 x H 124 cm	1998.55



**CADDIE «Teseo CR Easy ST»
Kofferwagen
Chariot à bagages**

Edelstahlrohr, seitliche Abweisinge, Bodenplatte in Edelstahl, 4 Schwenkrollen Ø 160 mm, Beladung mit max. 200 kg.
Tubes acier inoxydable, base pleine in acier inoxydable, pare-chocs angulaires, 4 roulettes pivotantes Ø 160 mm, charge maximale de 200 kg.

Art-Nr./No d'article	Grösse/grandeur	Gewicht/poids	Preis/prix
8490.06106	100 x 56 x H 160 cm	25 kg	1164.45



**CADDIE «Orsa In»
Kofferwagen
Chariot à bagages**

Edelstahlrohr gebürstet Ø 28 mm, platzsparend zusammenklappbar bei Nichtgebrauch, ummantelter Handgriff, strapazierfähiger Teppich aus 100% Polypropylen, 2 Rollen Ø 300 mm, Beladung mit max. 150 kg.
Tubes acier inoxydable brossé Ø 28 mm, plateforme repliable et rails de pose avec protection, poignée gainée, moquette très résistante 100% polypropylène, 2 roulettes Ø 300 mm, charge maximale de 150 kg.

Art-Nr./No d'article	Grösse/grandeur	Gewicht/poids	Preis/prix
8490.06107	105,2 x 57,3 x H 121,7 cm ■	30 kg	1398.75
8490.06108	105,2 x 57,3 x H 121,7 cm ■	30 kg	1398.75
8490.06109	105,2 x 57,3 x H 121,7 cm ■	30 kg	1398.75
8490.06110	105,2 x 57,3 x H 121,7 cm ■	30 kg	1398.75

HYGIENE / HYGIÈNE



8006.10230

T23



Mobiles Handwaschbecken Lave-mains mobile

Fahrbares Waschbecken inkl. Kanister à 13 Liter für Frischwasser (mit Beschilderung) und Kanister à 13 Liter für Schmutzwasser, herausnehmbarer Abfalleimer 13 Liter, Seifenspender 0,5 Liter, Spender für Papierhandtücher (Länge max. 25 cm)

Lave-mains mobile incl. bidon à 13 litres pour eau propre (avec étiquette) et bidon à 13 litres pour eaux usées, poubelle amovible 13 litres, distributeur de savon 0,5 litres, distributeur de papier (pour essuie-main plié de largeur maxi 25 cm)

Kaltwasser mit Fusspumpe Eau froide, avec pompe à pied

Art-Nr./No d'article Grösse/grandeur
8006.10200 48,3 x 42,2 x H 124,3 cm

Preis/prix
1324.25

Kaltwasser, mit elektrischer Pumpe mit Fusspedal, inkl. 2 Batterien Eau froide, avec pompe électrique à commande à pied, incl. 2 piles

Art-Nr./No d'article Grösse/grandeur
8006.10220 48,3 x 42,2 x H 124,3 cm

Preis/prix
1644.75

Heisswasser, mit Durchlauferhitzer und elektrischer Pumpe mit Fusspedal Eau chaude, avec chauffe-eau et pompe électrique à commande à pied

Art-Nr./No d'article Grösse/grandeur Anschlusswert/puissance Preis/prix
8006.10230 48,3 x 42,2 x H 124,3 cm 230 V / 3,6 kW / 50-60 Hz **3175.00**



Seifenspender für Wechselflaschen mit Schloss
Distributeur de savon pour bouteilles échangeables avec serrure

Für handelsübliche Wechselflaschen oder mit Nachfülltank.
 Pour bouteilles de réchange courantes ou avec tank à remplir.

Art-Nr./No d'article	Grösse/grandeur	Flaschen/bouteilles	Preis/prix
8600004	66 x 110 x H 266 mm	500 ml	223.40
8600025	76 x 120 x H 298 mm	950 ml	233.85



Seifen- und Desinfektionsmittelspender
Distributeur de savon et de désinfectant

Ohne Handkontakt bedienbar, frei befüllbar mit Flüssigseifen, Waschlotionen oder Desinfektionsmitteln, Vorratsbehälter fasst 1000 ml.
 Peut être utilisé sans contact, peut être rempli avec savons liquides, lotions ou désinfectants, réservoir a une capacité de 1000 ml.

Art-Nr./No d'article	Grösse/grandeur	Preis/prix
8600129	93 x 197 x H 302 mm	233.85



Handtuchspender
Distributeur de essui-mains

Abschliessbare Ausführung mit Füllstandanzeige, für 300 Papiertücher.
 Version verrouillable avec indicateur de niveau, pour 300 serviettes.

Art-Nr./No d'article	Grösse/grandeur	Preis/prix
8600006	310 x 126 x H 300 mm	270.35



Handtuchspender
Distributeur de essui-mains

Abschliessbare Ausführung mit Füllstandanzeige, für 500 Papiertücher.
 Version verrouillable avec indicateur de niveau, pour 500 serviettes.

Art-Nr./No d'article	Grösse/grandeur	Preis/prix
8600022	298 x 120 x H 298 mm	282.10



Papierkorb
Corbeille à papiers

Zur Wandmontage geeignete, robuste und rostfreie Qualität.
 Pour le montage au mur, qualité solide et inoxydable.

Art-Nr./No d'article	Grösse/grandeur	Preis/prix
8600029	340 x 265 x H 425 mm	98.80



Desinfektionsmittel-Spender
Distributeur de désinfectant

Stahl schwarz, inkl. 3 dl Flasche (leer) und 5 L Desinfektionsmittel mit Trichter
Acier noir, incl. bouteille 3 dl (vide) et 5 L de désinfectant avec entonnoir

Art-Nr./No d'article Grösse/grandeur
7599990 500 ml, 25 x 25, H 100 cm

Preis/prix
586.80



Desinfektionsmittel-Spender
Distributeur de désinfectant

Chromnickelstahl, spü Imaschinenfeste Tropfauffangschale, inkl. 5 L Desinfektionsmittel
Acier inoxydable, bac d'égouttement, lavable au lave-vaisselle, avec 5 L de désinfectant

Art-Nr./No d'article Grösse/grandeur
8600129999 5 L, 40 x 40, H 140 cm

Preis/prix
1164.40



Desinfektionsmittel-Spender
Distributeur de désinfectant

Chromnickelstahl, zur Wandmontage, für Pumpflaschen 500 bis 1000 ml, höhenverstellbar von 210-270 mm, inkl. Flasche mit 500 ml Desinfektionsmittel
En acier inoxydable, montage murale, pour flacons pompe de 500 à 1000 ml, hauteur réglable de 210-270 mm, 1 flacon avec 500 ml de désinfectant incl.

Art-Nr./No d'article Grösse/grandeur
8600138999 120 x 198 x H 300 mm

Preis/prix
99.90



**«Spray»
Desinfektionspender
Distributeur de désinfectant**

für das kontaktlose Desinfizieren der Hände für die Wandmontage, Inhalt ca. 1 Liter, für 6 Stk. Batterien Typ AA (LR6 / 1,5v). Batterien und Desinfektionsmittel nicht im Lieferumfang enthalten.

pour la désinfection sans contact des mains, pour montage mural, capacité d'environ 1 litre, pour 6 piles de type AA (LR6 / 1,5v). Piles et désinfectant non inclus.

Art-Nr./No d'article **8582.98255** Grösse/grandeur 13,5 x 12,5 x H 26 cm

Preis/prix **132.90**



**«Spray»
Desinfektionspender
Distributeur de désinfectant**

für das kontaktlose Desinfizieren der Hände, Tischmodell, Inhalt ca. 1 Liter, für 6 Stk. Batterien Typ AA (LR6 / 1,5v). Batterien und Desinfektionsmittel nicht im Lieferumfang enthalten.

pour la désinfection sans contact des mains, modèle de table, capacité d'environ 1 litre, pour 6 piles de type AA (LR6 / 1,5v). Piles et désinfectant non inclus.

Art-Nr./No d'article **8582.98260** Grösse/grandeur 13,5 x 12,5 x H 47 cm

Preis/prix **152.70**



**Handschuhspender
Distributeur de gants**

Edelstahl, für Einmalhandschuhe in Standardkarton (25 x 13 x H 7,8 cm), Fassungsvermögen 1 Karton, zur Wandmontage, inklusive Befestigungsmaterial
Acier inoxydable, pour gants jetables dans une boîte standard (25 x 13 x H 7,8 cm), capacité 1 boîte, pour montage mural, y compris matériel de fixation

Art-Nr./No d'article **8006.70810** Grösse/grandeur 13 x 8 x H 25,1 cm

Preis/prix **76.45**

Handschuhe nicht im Lieferumfang enthalten.
Gants non inclus.



**Handschuhspender
Distributeur de gants**

Edelstahl, für Einmalhandschuhe in Standardkarton (25 x 13 x H 7,8 cm), Fassungsvermögen 2 Kartons, zur Wandmontage, inklusive Befestigungsmaterial
Acier inoxydable, pour gants jetables dans une boîte standard (25 x 13 x H 7,8 cm), capacité 2 boîtes, pour montage mural, y compris matériel de fixation

Art-Nr./No d'article **8006.70811** Grösse/grandeur 26 x 9,6 x H 25,9 cm

Preis/prix **79.95**

Handschuhe nicht im Lieferumfang enthalten.
Gants non inclus.



**Handschuhspender
Distributeur de gants**

Edelstahl, für Einmalhandschuhe in Standardkarton (25 x 13 x H 7,8 cm), Fassungsvermögen 3 Kartons, Markierung der Handschuhgrössen am Spender, zur Wandmontage, inklusive Befestigungsmaterial
Acier inoxydable, pour gants jetables dans une boîte standard (25 x 13 x H 7,8 cm), capacité 3 boîtes, marquage des tailles de gants sur le distributeur, pour montage mural, y compris matériel de fixation

Art-Nr./No d'article **8006.70812** Grösse/grandeur 26 x 9,5 x H 39 cm

Preis/prix **85.85**

Handschuhe nicht im Lieferumfang enthalten.
Gants non inclus.

REGALE / RAYONNAGE



HUPFER

Gerne beraten wir Sie persönlich oder verlangen Sie nach unserem Regalprogramm.

Nous serions ravis de vous conseiller en personne. Demandez notre catalogue d'étagères.

Die Vielfalt für sämtliche Lagersituationen

Die Anforderungen an die Logistik sind heute in jedem modernen Küchenbetrieb anspruchsvoll. Gerade die Logistikfunktion Lagern ist hierbei von zentraler Bedeutung, da dies die Grundlage ist für einen kontinuierlichen und hygienisch einwandfreien Küchenbetrieb. Wir bieten für alle spezifischen Lagerfragen, insbesondere für die Lebensmittellagerung, die richtige Lösung. Mit einer Vielzahl an Zusatzausstattungen kann das Regalprogramm im Detail an einen individuellen Bedarf angepasst und so zur hilfreichen Unterstützung im täglichen Arbeitsprozess werden.

Une offre variée pour tous les types de stockage

Les exigences logistiques sont aujourd'hui élevées dans tous les établissements de restauration modernes. Le stockage est une question logistique centrale, puisqu'il est à la base d'un travail en cuisine ininterrompu et parfaitement hygiénique. Nous proposons la solution adaptée à chaque besoin spécifique en termes de stockage, notamment alimentaire. Nos nombreux accessoires permettent d'adapter spécifiquement la gamme d'étagères à chaque besoin individuel. Une aide précieuse pour les activités quotidiennes.



LASER-GRAVUR / GRAVURE AU LASER



Individuell bis ins letzte Detail - dank Lasergravur

Mit unserem hauseigenen Laser sind wir in der Lage, verschiedenste Materialien wie Glas, Holz, Kunststoff oder Acryl zu gravieren. Dünne Produkte wie zum Beispiel Tischsets aus Kunststoff oder Leder können wir sogar schneiden und so für Sie auf exakte Masse anpassen.

Gravure au laser - Même en petites quantités

Grâce à notre propre laser, nous sommes en mesure de graver les matériaux les plus divers, comme le verre, le bois, le plastique ou l'acrylique. Nous pouvons même découper des produits fins, comme des sets de table en plastique ou en cuir, et les tailler pour vous aux dimensions exactes.

Zeigen Sie Ihren Gästen in jedem Detail, dass Sie stolz auf Ihren Betrieb sind und personalisieren Sie Ihre Produkte mit Ihrem Logo, einem Slogan oder was auch immer Ihnen in den Sinn kommt.

Montrez à vos clients que vous êtes fier de votre entreprise dans les moindres détails et personnalisez vos produits avec votre logo, un slogan ou tout ce qui vous vient à l'esprit.



Für detaillierte Informationen besuchen Sie: www.berndorf.ch/de/produkte/laser_gravur
Pour des informations détaillées, visitez: www.berndorf.ch/fr/produits/gravure_laser

Wir freuen uns auf Ihre Kontaktaufnahme!
Nous nous réjouissons de votre prise de contact!

Allgemeine Verkaufs- und Lieferbedingungen der Berndorf Luzern AG

1. Allgemeines

Durch Bestellung und Annahme der Ware erklärt sich der Kunde mit den allgemeinen Verkaufs- und Lieferbedingungen der Berndorf Luzern AG einverstanden.

2. Bestätigung Bestellungsingang

Bei der schriftlichen oder telefonischen Bestellung handelt es sich um ein Angebot zum Vertragsschluss (Offerte). Die Bestellung gilt mit Eingang der schriftlichen Auftragsbestätigung bzw. des Lieferscheins der Berndorf Luzern AG beim Kunden als angenommen (Annahme). Vorbehalten bleiben die Absage seitens der Zulieferanten der Berndorf Luzern AG und Fälle von höherer Gewalt.

3. Preise

Die Preise verstehen sich netto in Schweizer Franken, exkl. MwSt. Die Preise sind freibleibend und können jederzeit ohne Vorankündigung geändert werden.

4. Lieferfristen

Wir setzen alles daran, die im Katalog publizierten oder von uns bestellten Lieferfristen einzuhalten. Lieferverzögerungen ermächtigen den Käufer nicht, vom Vertrag zurückzutreten oder etwaliche Ansprüche geltend zu machen.

5. Lieferung

Die Verpackungseinheiten gemäss Preisliste der Berndorf Luzern AG sind einzuhalten. Die Teillieferung einzelner (von mehreren bestellten) Artikel(n) ist zulässig. Beim Porzellan ist eine produktionsbedingte Über- oder Unterlieferung von bis zu +/- 10% zu akzeptieren.

Änderungen nach Bestellungsingang, auch solche, die aus baulichen Gründen notwendig sind, werden dem Kunden zusätzlich in Rechnung gestellt. Technische Änderungen an den Kaufobjekten (speziell Apparate) können vom Verkäufer im Interesse des technischen Fortschrittes bis zur Auslieferung vorgenommen werden.

Lieferung erfolgt nach Ermessen der Berndorf Luzern AG entweder mit Camion, Bahn oder Postversand franko Haus ab Fr. 1'000.–. Bei Bestellungen unter Fr. 1'000.– verrechnet die Berndorf Luzern AG einen Versandkostenanteil von minimal Fr. 34.50. Expresszuschläge gehen zu Lasten des Empfängers, sofern die Berndorf Luzern AG kein Verschulden trifft. Kleinmengenzuschläge bleiben vorbehalten.

6. Beanstandungen

Bei Lieferung durch den Camion muss dem Fahrzeuglenker ein allfälliger Transportschaden sofort bei Ankunft der Ware mitgeteilt werden. Der Schaden ist dabei auf dem Lieferscheindoppel zu vermerken. Bei Bahn- oder Postversand muss sich der Empfänger einen allfälligen Transportschaden von der Transportanstalt protokollieren lassen. Für solche Transportschäden haftet die Post bzw. die Bahn. Beanstandungen, denen ein Protokoll bzw. Lieferscheindoppel nicht beiliegt, können wir leider nicht berücksichtigen. Alle Lieferungen sind nach Erhalt auf Richtigkeit zu kontrollieren. Reklamationen müssen sofort nach Erhalt der Ware mitgeteilt werden. Nutzen und Gefahr gehen mit dem Bereitstellen zum Versand auf den Kunden über.

7. Montage von Apparaten

Ist die Montage durch die Berndorf Luzern AG oder durch sie beauftragte Dritte vorgesehen, so hat der Käufer die Ware zum Zeitpunkt der Lieferung an bis zur Montage auf seine Kosten und sein Risiko in sicheren und trockenen Räumen einzulagern. Die Montagekosten sind vom Käufer zusätzlich zum Kaufpreis zu bezahlen. Sofern in Angeboten oder Kaufverträgen nicht anders vermerkt, sind die folgenden Leistungen immer vom Käufer zu erbringen:

- Sämtliche Zu- und Ableitungen (Strom, Wasser, etc.) bis zum Kaufobjekt hin und von diesem weg, inkl. Anschluss an das Kaufobjekt.
- Die Maurer-, Stemm- und Verputzarbeiten.
- Die Bereitstellung von Strom, Wasser, Heizmaterial, Bagerüst und die für die Inbetriebnahme und die Testläufe notwendigen Materialien.
- Die Einbringungsöffnungen für die gelieferten Waren.
- Fundamente, Konsolen, Podeste, etc.
- Abhilfe bei normalen Schwankungen in der Stromversorgung bzw. Abhilfe bei hohen Induktionsströmen.

8. Zahlungsbedingungen

Netto 30 Tage nach Rechnungsstellung ohne Abzug von Skonto. Zahlungen sind in Schweizer Franken zu leisten. Ab Fr. 10'000.– Warenwert verrechnet die Berndorf Luzern AG Teilzahlungen: 50% bei Auftragserteilung, 50% netto 30 Tage nach Rechnungsstellung.

9. Eigentumsvorbehalt

Sämtliche Kaufobjekte bleiben bis zur vollständigen Bezahlung Eigentum der Berndorf Luzern AG. Die Berndorf Luzern AG behält sich vor, den Eigentumsvorbehalt im Eigentumsverhaltensregister eintragen zu lassen.

10. Retouren

Bestellte und richtig gelieferte Waren werden nur ausnahmsweise und nach vorheriger Vereinbarung in der Originalverpackung zurückgenommen. Spezialanfertigungen oder Sonderbestellungen können nicht zurückgenommen werden.

11. Muster

Muster werden bei Versand in Rechnung gestellt, mit einem Zahlungsziel von 60 Tagen. Falls diese nicht innert 8 Wochen in Originalverpackung zurückgesandt werden, gehen wir davon aus, dass der Kunde die Muster behalten will und fordern den Rechnungsbetrag ein.

12. Garantie für Apparate

Die gesetzlich vorgesehene Gewährleistungsregelung für Rechts- und Sachmängel wird wegbedungen. An ihre Stelle tritt folgende Garantieregelung: Der Käufer oder sein Rechtsnachfolger hat während der Garantiefrist einen zusammen mit dem Kaufsache übertragbaren Anspruch auf kostenlose Nachbesserung.

Die Garantiefrist beträgt 1 Jahr seit Versand oder Übergabe der Kaufsache. Die Garantiezeit für ersetzte Teile beträgt 1 Jahr. Weitergehende Ansprüche für mittelbare und/oder unmittelbare Mangelfolgeschäden werden ausdrücklich wegbedungen.

13. Anwendbares Recht

Es ist schweizerisches Recht anwendbar.

14. Gerichtsstand

Ausschliesslicher Gerichtsstand ist der Geschäftssitz der Berndorf Luzern AG.

Wir wünschen Ihnen viel Freude mit Produkten der Berndorf Luzern AG.

Oktober 2023

Conditions générales de vente et de livraison de Berndorf Lucerne SA

1. Généralités

En commandant et en prenant en charge la marchandise livrée, le client déclare approuver les conditions générales de vente et de livraison de Berndorf Lucerne SA.

2. Confirmation de l'entrée de la commande

La commande écrite ou téléphonique est considérée comme une demande d'offre. La commande est considérée acceptée par le client (prise en charge) lorsqu'il reçoit la confirmation de commande écrite ou le bulletin de livraison de la part de Berndorf Lucerne SA. Sous réserve d'une impossibilité de livraison de la part des fournisseurs de Berndorf Lucerne SA ou en cas de force majeure.

3. Prix

Les prix s'entendent nets en francs suisses, TVA non comprise. Les prix sont sans engagement et peuvent être modifiés en tout temps sans préavis.

4. Délais de livraison

Les délais indicatifs indiqués dans nos catalogues ou confirmés sont respectés dans toute la mesure du possible. Un retard n'autorise pas l'acheteur à résilier le contrat ou à faire valoir des dommages et intérêts.

5. Livraison

Les unités d'emballage figurant dans la liste de prix de Berndorf Lucerne SA doivent être respectées. La livraison partielle d'articles (commandés en plusieurs exemplaires) est autorisée. Lors de la livraison d'articles en porcelaine, une marge de plus ou moins 10% de la quantité commandée doit être acceptée pour des raisons de production. Toute modification intervenant après la réception de la commande, même celle qui s'avère nécessaire pour des raisons inhérentes à la construction, sera facturée en sus au client. Dans l'intérêt du progrès technique, le vendeur peut apporter des modifications techniques aux objets vendus (appareils spéciaux), et ce jusqu'à leur livraison. La livraison a lieu par camion, chemins de fer ou envoi postal franco domicile à partir de Fr. 1'000.–, en fonction de la décision de Berndorf Lucerne SA. Pour les commandes en dessous de Fr. 1'000.–, Berndorf Lucerne SA facture une participation aux frais d'expédition de Fr. 34.50 au minimum. Les majorations pour livraison express sont à la charge du destinataire, pour autant qu'aucune faute ne soit imputable à Berndorf Lucerne SA. Les suppléments pour la petite quantité restent réservés.

6. Réclamations

Lorsque la livraison est effectuée par camion, les éventuels dommages survenus au cours du transport doivent être signalés au chauffeur du véhicule immédiatement à l'arrivée de la marchandise. Le dommage doit être indiqué sur le double du bulletin de livraison. En cas d'envoi par les chemins de fer ou par la poste, le destinataire doit faire enregistrer le dommage survenu au cours du transport dans un procès-verbal par l'entreprise chargée du transport. La poste respectivement les chemins de fer sont responsables de tels dommages de transport. Nous ne pouvons malheureusement pas tenir compte de réclamations qui ne sont pas accompagnées d'un procès-verbal respectivement du double du bulletin de livraison. Toutes les livraisons doivent être vérifiées dès réception. Les réclamations doivent être communiquées immédiatement à réception de la marchandise. Les avantages et les risques passent au client lors de la préparation à l'expédition.

7. Installation des appareils

S'il est prévu que l'installation des appareils soit effectuée par Berndorf Lucerne SA ou par un tiers qu'elle aura mandaté à cette fin, l'acheteur est tenu, entre le moment de la livraison et celui de l'installation des appareils, d'entreposer la marchandise à ses frais et à ses risques dans un lieu sûr et à l'abri de l'humidité. Les frais d'installation sont à la charge de l'acheteur et sont dus en sus du prix de vente. A moins que les offres ou les contrats de vente n'en disposent autrement, les prestations énumérées ci-dessous sont toujours à charge de l'acheteur:

- L'ensemble des conduites d'aménage et d'évacuation (courant électrique, eau, etc.) jusqu'à l'objet de la vente et à partir de celui-ci, y compris le raccordement à l'objet de la vente.
- Les travaux de maçonnerie, de perçement et de crépissage.
- La mise à disposition de courant électrique, d'eau, de matériel de chauffage, d'échafaudage et du matériel nécessaire à la mise en service et aux essais.
- Les ouvertures nécessaires à la mise en place des marchandises livrées.
- Les fondations, consoles, plates-formes, etc.
- Le dépannage en cas de fluctuations anormales dans l'alimentation électrique et le dépannage en présence de courants d'induction élevés.

8. Conditions de paiement

30 jours net à partir de la date de la facture sans déduction d'escompte. Les paiements doivent être effectués en francs suisses. Lorsque la valeur des marchandises dépasse Fr. 10'000.– Berndorf Lucerne SA facture le montant dû payable en deux tiers: 50% lors de la passation de la commande, 50% net 30 jours à partir de la date de la facture.

9. Réserve de propriété

Tant qu'ils n'ont pas été entièrement payés, les objets vendus restent propriété de Berndorf Lucerne SA. Berndorf Lucerne SA se réserve le droit de faire inscrire la réserve de propriété au registre des réserves de propriété.

10. Reprises

Les marchandises commandées et livrées en bonne et due forme ne sont reprises qu'exceptionnellement et seulement après en avoir convenu, dans leur emballage original. Les fabrications spéciales ou les commandes spéciales ne peuvent plus être reprises.

11. Echantillons

Les envois d'échantillons sont facturés automatiquement avec un délai de paiement de 60 jours. Le montant intégral est crédité lors du renvoi de la marchandise en parfait état et dans l'emballage d'origine. Nous supposons que le client préfère d'acheter les échantillons qui n'ont pas été retournés dans les 8 semaines et envoyons un rappel pour le paiement.

12. Garantie relative aux appareils

Les règles de garantie prévues par la loi en matière de défauts matériels et de vices juridiques sont exclues. A leur place interviennent les règles suivantes: Pendant le délai de garantie, l'acheteur ou son ayant cause dispose d'un droit, transmissible avec la chose vendue, à la correction gratuite du défaut ou du vice constaté. Le délai de garantie est de une année à compter de l'expédition ou de la remise de la chose vendue. La durée de la garantie pour les pièces remplacées est d'une année. Toute autre prétention plus étendue à raison de dommages directement et/ou indirectement consécutifs au défaut est expressément exclue.

13. Droit applicable

Seules les dispositions du droit suisse sont applicables.

14. For juridique

Le siège de Berndorf Lucerne SA est le for juridique exclusif.

Nous vous souhaitons beaucoup de plaisir avec les produits de Berndorf Lucerne SA.

octobre 2023

Condizioni generali di vendita e fornitura della Berndorf Lucerna SA

1. In generale

L'acquisto e la fornitura della merce implicano da parte del cliente l'accettazione delle condizioni generali di vendita e di fornitura della Berndorf Lucerna SA.

2. Conferma di avvenuta ordinazione

L'ordinazione effettuata per iscritto o per telefono ha valore di proposta di contratto (offerta). L'ordinazione è effettiva quando il cliente riceve la conferma scritta o il foglio di fornitura da parte della Berndorf Lucerna SA (conferma). Restano riservati i casi di rifiuto da parte dei fornitori della Berndorf Lucerna SA e i casi di forza maggiore.

3. Prezzi

I prezzi sono espressi in franchi svizzeri al netto, IVA esclusa. I prezzi non sono vincolanti e possono essere modificati in qualsiasi momento senza preavviso.

4. Termini di consegna

Facciamo tutto il possibile per rispettare i termini di consegna pubblicati nel catalogo o da noi confermati. Eventuali ritardi nella consegna non autorizzano l'acquirente a recedere dal contratto o rivendicare qualsivoglia pretesa.

5. Consegna

Le unità di consegna indicate nella lista dei prezzi della Berndorf Lucerna SA vanno rispettate. La fornitura parziale di singoli articoli (in un'ordinazione composta da più articoli) è ammessa. Nel caso delle porcelane una eventuale differenza del +/- 10% sui pezzi forniti, dovuto alla produzione, è da considerarsi normale e va accettata. Modifiche posteriori al ricevimento dell'ordinazione, anche quelle necessarie per motivi edili, vengono fatturate al cliente quale supplemento. Modifiche tecniche agli oggetti in vendita (in special modo apparecchi) possono essere eseguite dal venditore fino alla fornitura, nell'interesse del progresso della tecnica. La consegna avverrà a giudizio della Berndorf Lucerna SA via camion, ferrovia o tramite la consegna postale a domicilio a partire da Fr. 1'000.–. Per ordinazioni inferiori a Fr. 1'000.–, la Berndorf Lucerna SA fattura una partecipazione ai costi di Fr. 34.50 al minimo. Il supplemento per la consegna espresso va addebitato al destinatario, sempre che la Berndorf Lucerna SA non abbia alcuna responsabilità. I supplementi per la piccola quantità sono riservati.

6. Reclami

Eventuali danni causati dal trasporto tramite camion devono essere segnalati immediatamente al conducente. Il danno va indicato nella copia del bollettino di consegna. Nel caso di un eventuale danno della merce trasportata tramite ferrovia o posta, il destinatario deve farsi rilasciare una dichiarazione scritta in merito. I danni, in questi casi, sono assunti dalle ferrovie risp. dalla posta. La Berndorf Lucerna SA non può accettare reclami che non presentano allegata una dichiarazione scritta o la copia del bollettino di consegna. Tutte le forniture vanno controllate al momento del ricevimento. Eventuali reclami vanno inoltrati immediatamente dopo ricevimento della merce. Vantaggi e pericoli del trasporto sono a carico del cliente.

7. Installazione di apparecchi

Se è previsto che l'installazione venga effettuata dalla Berndorf Lucerna SA o da terzi da essa incaricati, il l'acquirente è tenuto a immagazzinare la merce in luoghi sicuri e asciutti dal momento della fornitura fino all'installazione, a proprie spese e rischio. L'acquirente è tenuto a pagare a parte le spese di montaggio, quale supplemento al prezzo di acquisto. A meno che non sia indicato altrimenti nelle offerte o nei contratti di acquisto, le seguenti prestazioni vanno sempre fornite dall'acquirente:

- tutte le condotte di alimentazione e di scarico (corrente elettrica, acqua, ecc.) fino all'oggetto dell'acquisto e a partire da esso, ivi compreso l'allaccio al medesimo.
- i lavori di muratura, di mortasatura e di inonacatura.
- la messa a disposizione di corrente elettrica, acqua, materiale da riscaldamento, impalpature e il materiale necessario per la messa in esercizio e per le prove.
- le aperture di apporto per la merce fornita.
- fondamenta, mensole, pedane/pianerottoli, etc.
- misure per eliminare i disturbi in caso di fluttuazioni anormali nell'alimentazione di energia elettrica, o misure in caso di grandi flussi di induzione.

8. Condizioni di pagamento

Al netto, 30 giorni dopo fatturazione senza deduzioni di sconti. I pagamenti vanno effettuati in franchi svizzeri. A partire da un valore della merce di Fr. 10'000.– la Berndorf Lucerna SA fattura la somma in due rate: 50% al momento dell'ordinazione, 50% netto 30 giorni dopo la fatturazione.

9. Riserva di proprietà

Tutti gli oggetti restano proprietà della Berndorf Lucerna SA fino al loro totale pagamento. La Berndorf Lucerna SA si riserva il diritto di iscrivere tale proprietà sul registro dei patti di riserva della proprietà.

10. Ritorni

Le merci ordinate e fornite correttamente vengono accettate in ritorno solo in via eccezionale e dopo accordi nel loro imballaggio originale. Oggetti con lavorazioni appositamente realizzate per il cliente oppure ordinazioni particolari non possono essere ritornate.

11. Campioni

I campioni vengono fatturati al momento dell'invio, con termine di pagamento 60 giorni. Se i campioni non vengono rispediti entro 8 settimane nell'imballaggio originale, partiamo dal presupposto che il cliente desidera tenerli e reclamiamo l'importo secondo fattura.

12. Garanzia per apparecchi

Le disposizioni di garanzia previste dalla legge in caso di evizione e per difetti della cosa viene escluse. Essa sono sostituite dalla seguente garanzia: durante il periodo di garanzia all'acquirente o al di lui successore legale spetta il diritto alla riparazione gratuita, diritto trasferibile assieme all'oggetto dell'acquisto. Il periodo di garanzia è di 1 anno a contare dalla spedizione o dalla consegna dell'oggetto dell'acquisto. Il periodo di garanzia per pezzi sostituiti è di 1 anno. Pretese più estese per danni diretti e/o indiretti consecutivi al difetto sono espressamente escluse.

13. Diritto applicabile

Diritto svizzero.

14. Foro competente

Foro competente esclusivo è la sede commerciale della Berndorf Lucerna SA.

Vi auguriamo molta soddisfazione con i prodotti Berndorf Lucerna SA.

ottobre 2023



SWISS DELUXE HOTELS
PREFERRED SUPPLIER



VEREINIGUNG DIPLOMIERTER
HOTELIERS RESTAURATEURE SHV
HOTELMANAGER NDS HF



Berndorf Luzern AG
Industriestrasse 15
CH-6203 Sempach Station
Telefon 041 259 21 41
www.berndorf.ch
info@berndorf.ch



Berndorf Luzern AG
Industriestrasse 15
CH-6203 Sempach Station
Tél. 021 983 25 00
www.solutionsbeard.ch
info@solutionsbeard.ch

